

The Daily Edition

50¢

Serving Loudon, Monroe and Surrounding Counties

Wednesday, May 3, 2017

9th DTF serve search warrant; find needles, pipes, pills and more

Cole Winger, 32, Avery Street Loudon, was charged with Legend Drugs, and Poss. of Drug Para.

Loudon County Narcotics Unit and the 9th DTF served a search warrant at Avery St. in Lenoir City, Tn. Needles, aluminum foil, five (5) methamphetamine pipes, straws, one bottle of pills

(see 9th DTF pg. 2)



Cole Winger

Meth and more found on speeding driver



Daniel Langley

see meth pg. 3

Just a couple of xanax? Plethora of pills found following wreck



Teonna Russell

see wreck pg. 5

Revoked driver charged with DUI following call

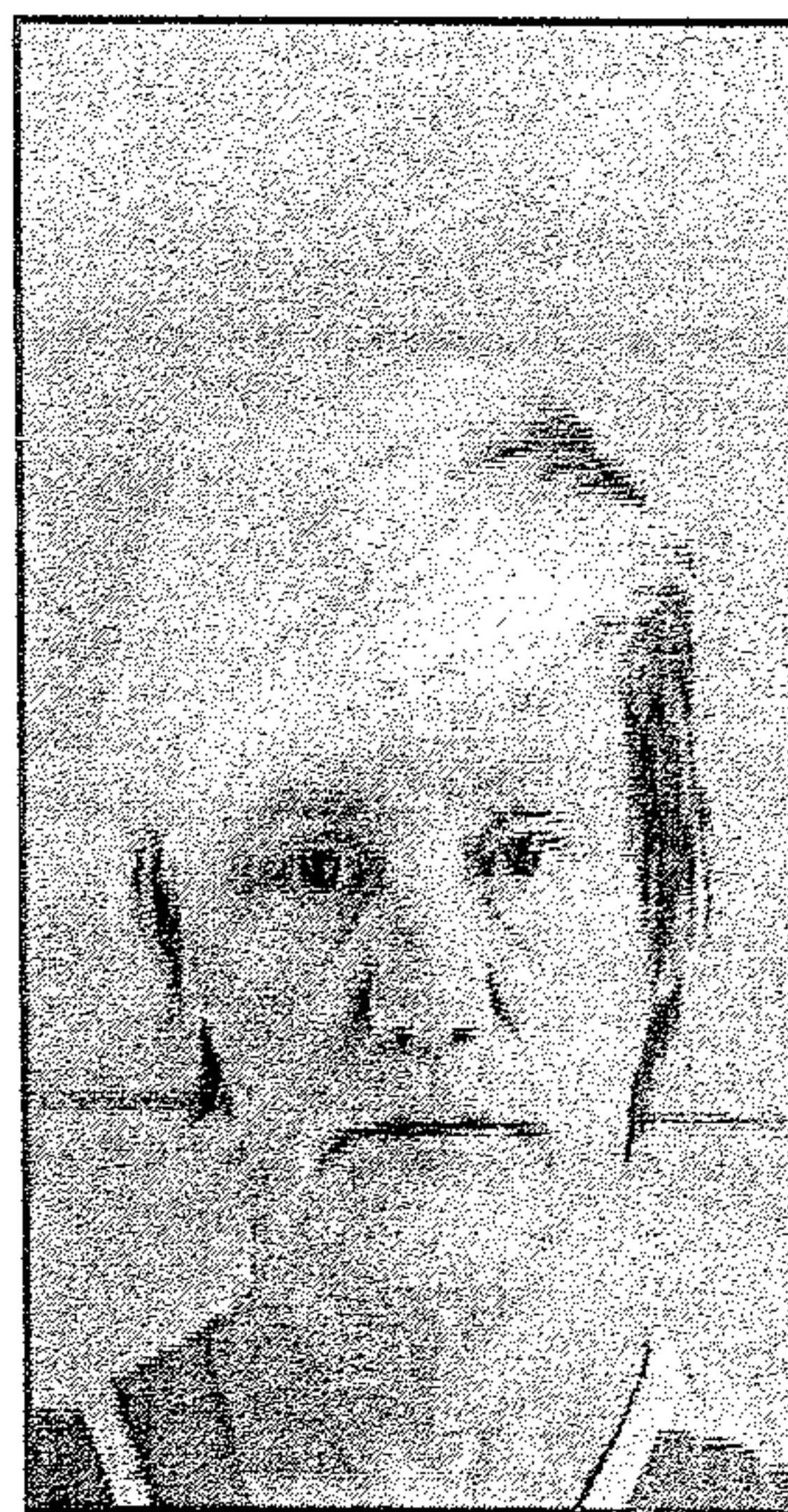

Melinda Majors

see DUI pg. 7

Limestone Couple sentenced for federal tax evasion

On May 1, 2017, David Lee Byrd, 58, and his wife, Paula Ruth Hall Byrd, 58, both of Limestone, Tennessee, were sentenced by the Honorable J. Ronnie Greer, U.S. District Judge. David Byrd was ordered to serve 10 months in federal prison followed by three years of supervised release. Paula Byrd was ordered to serve four years on

probation. Both were ordered to pay restitution of \$134,359 to the Internal Revenue Service (IRS), fines of \$5,000 each, and \$100 special assessments.

Both David and Paula Byrd pleaded guilty in December 2016 to an information charging them with income tax evasion for the year 2008. Information

(see tax pg. 4)

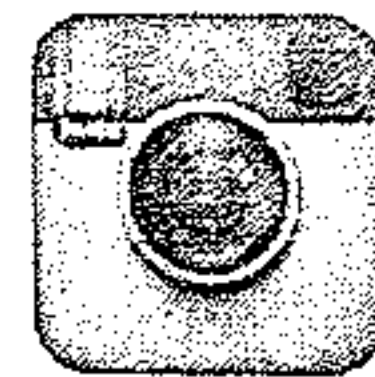

Follow us on Instagram



Verse of the Day

Hatred stirs up dissension, but love covers over all wrongs. — Proverbs 10:12
Obituaries
see inside

Wazzup

Wow hard to believe prom time is already here too. Sure was some well dressed young men and women over the weekend, they couldn't all be going to the same

formal event!

Weather

Today: Sunny, along with a few afternoon clouds. A stray shower or thunderstorm is possible. High 79F.
Tonight: Partly cloudy skies early will become

overcast later during the night. Slight chance of a rain shower. Low 62F.
Thursday Rain showers early with a steady, soaking rain later in the day. Increasing winds. Thunder possible. High 71F.

(Continued on page 6)

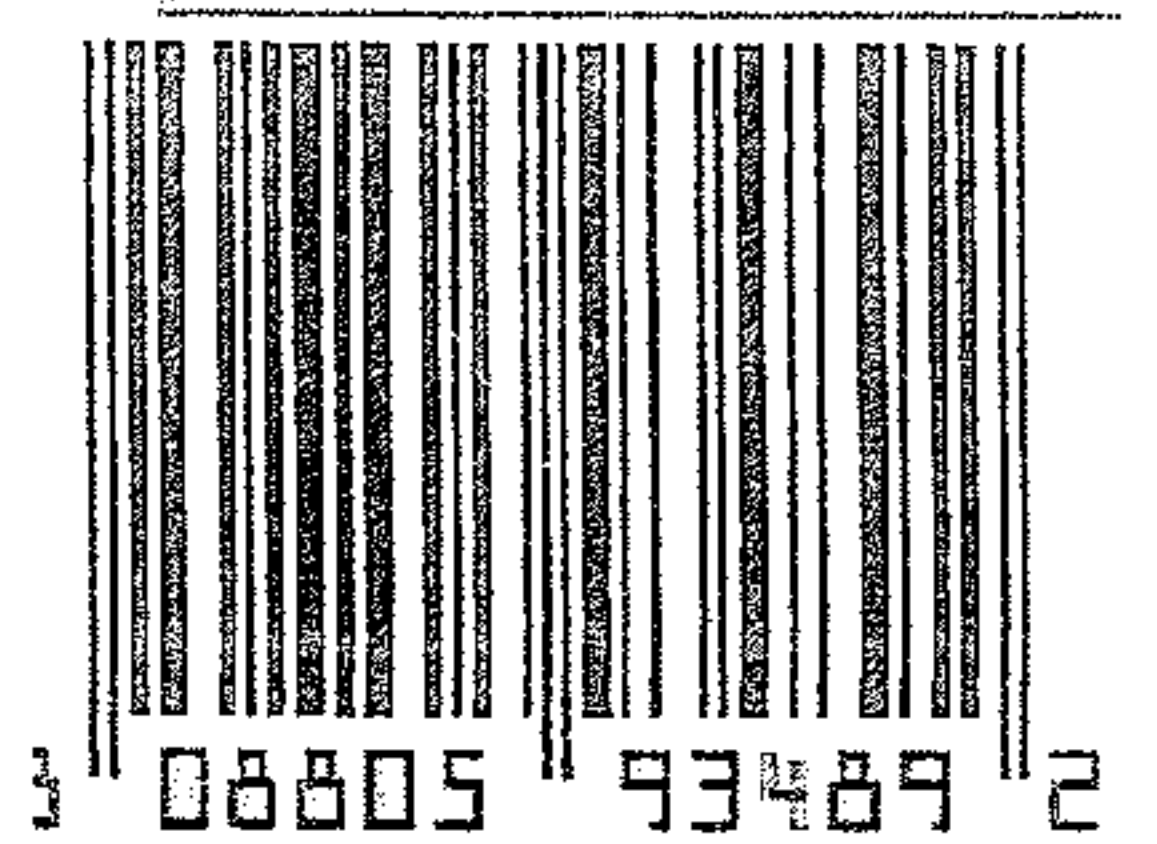

Help Wanted Drivers Needed

Malones Wrecker Service

must have "F" Endorsement on driver license

Call 986-0051

9th DTF

containing numerous 150mg Trazadone pills and one set of digital scales was located in the bedroom of Cole B. Winger. Mr. Winger was arrested and transported to the Loudon County Jail. These above actions did occur in Loudon County, Tn.

To Get a Burning Permit:

Loudon (865) 986-8395

Monroe (423) 442-7401

Roane (865) 354-1054

Notice: The Daily Edition does not knowingly accept fraudulent or misleading materials. The Daily Edition cannot guarantee the validity of offerings or statements contained herein. All liability for the contents of all advertising, and for any claims that may arise therefrom, is the responsibility of the advertiser or its agency. The Daily Edition reserves the right to reject, edit, or abbreviate any advertisement submitted. Advertising is accepted with the understanding that all liability for all copyright violations is the sole responsibility of the advertiser.

Photographs, artwork and other copy submitted for publication is considered the sole property of the advertiser. The Daily Edition will make every effort but will not be liable for failure to publish and ad or for typographical and layout errors. All statements and information about highlights featured items, letters to the editor, herein are those solely given to the interviewer or writer and the Daily Edition assumes no responsibility of the accuracy or validity thereof. The Daily Edition will gladly reprint at no charge that part of an advertisement in which an error occurs provided a claim is made within 3 days of the first publication of the ad. Information contained in the Wazzup is received anonymously and the Daily Edition assumes no responsibility for information and reserves the right to edit or reject any and/or all submissions. The Daily Edition is a daily newspaper of general circulation in Loudon County defined under TCA 2-1-104(a)(13).

The Daily Edition also serves Monroe, Knox, Anderson, Roane and Blount counties and serves 30,000 readers weekly. Send mail to PO Box 1240, Lenoir City TN 37771. 865-771-2249. email: dan1204us@yahoo.com

The Daily Edition is Loudon County's premier public interest and paid advertising paper. The Daily Edition is produced and published daily Monday through Friday and is circulated throughout Loudon County and parts of Monroe and Knox Counties. Display advertising rates \$5.00 per column inch and quantity discounts available. Call for information on upcoming promotions and events.

NEED HELP WITH INCOME TAX? PROFESSIONAL TAX SERVICE

PRICE - 95% of returns between \$60-\$140

(No Coupons Required)

LOCALLY Owned & Operated - Open Year Round

30+ Years in the business

ALL Preparers with 10+ years experience

Pro Tax

111 E. Broadway

Lenoir City, TN 37771

Phone 865-986-4035

*US Armed Service Active Duty Personnel, "THANK YOU", Tax Return Free

Good Credit OK • Bad Credit OK • Bankruptcies OK • Repo OK *



2004 BMW Z4 Convertible, 77k, Garage Kept, Alloy Wheels, Heated Seats, PS, PW,



2013 Nissan Altima 3.6 V6, PS, PW, PL, 75k, Like New, Auto, Push Star



2012 Jeep Liberty Alloy Wheels, Luggage Rack, V6, Auto, A/C, Low Miles, Back-Up Camera



2008 Ford F150 93k, EXT Cab, V8, Auto, Tow PKG, Bed Liner, Like New, PW, PL, A/C



2014 Ford Focus 55k, Alloy Wheels, 5 Speed, A/C, PW, PL, Sunroof, Factory Warranty



2012 BMW 335i Twin Power Turbo V6, NAV, Sport Pkg, Sunroof, Heated & Cooled Seats

DEPENDABLE MOTORS 986-9343

803 E. Broadway • Lenoir City

Serving Loudon County for 20 Years

* WAC. See Dealer for details

Visit our website at: www.dependablemotorslc.com

Meth

Daniel Langley, 23, Mealer Road Lenoir City, was charged with Driving on Revoked/Suspended License, Mfg/Del/Sale or Poss. of Meth, Poss. of Drug Para, Tampering/Fabrication with Evidence and Simple Possession. Deputy Kenneth Palmer LCSO, observed a silver vehicle traveling on Hwy 70 at a high rate of speed. Dep-

uty clocked the vehicle going 66mph in a 40 MPH zone. Deputy traffic stopped the vehicle and made contact with the driver Daniel Langley, Deputy could smell a strong odor of marijuana emitting from the vehicle. Deputy ask Langley to exit the vehicle Deputy noticed Langley to be chewing something at which time Deputy told him to open meth ctd. pg. 7



**Office Visit
as low as \$65**

First Med Farragut
Family Medical Clinic
Low Cost Office Visits
865-392-1840
(Not A Pain Clinic)



BIMBO'S

Deli Open 24 Hours
865-986-9643 Call Ins Welcome

Specials

**Lg. Cold Sub, bag of chips and 16 oz. fountain drink
only \$6.29**

Footlong Corn Dog \$2.59

West End Storage & Warehouses
502 Ward Avenue • Loudon
Call 865-458-4774 or 865-679-5555



**A Short Drive For A
Lifetime Of Quality**

**Nationally Published Artist
Brian Jones**

Serving East Tennessee since 1996

Always 100% Health Score

**Like Us On Facebook at
Living art tattoo of tn**

**Open Late on Weekends
Tues-Sat 1pm-9
Sun & Mon by appt.**

423-420-0380

Living Art Tattoo
Madisonville

**T
A
T
T
O
O**

**P
R
E
C
I
N
G**

**C&J Towing and
Recovery**

LOWEST TOWING RATES AROUND!!!

Have you been overcharged for any type of towing service in the Lenoir City area? If you have a breakdown or accident please OWNER REQUEST C&J Towing with the officer. Also please call your Sheriff and ask him to place C&J Towing on the "Rotation List*" and help other motorists save as much as you did! We at C&J are locally owned and operated, State approved, licensed, bonded and insured. Call and let us know if your denied service or how we can be of assistance.

*note: the "Rotation List" is a list of wrecker services that provide service for wrecks, DUI's, breakdowns, etc. and are on an on-call basis for service. This list is approved by the Sheriff.

Cliff Teeters • Owner
865-809-1661

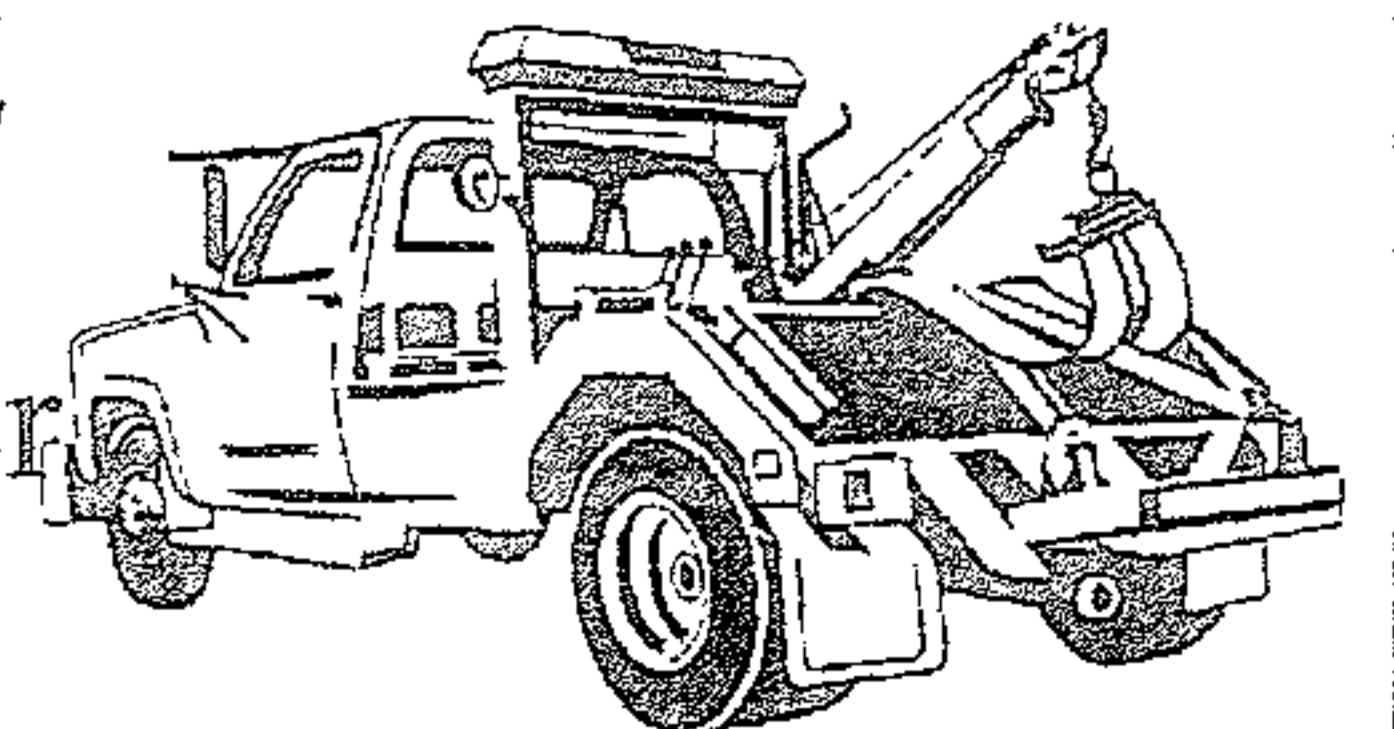

Tax

on file with the U.S. District Court shows that David and Paula Byrd were self-employed computer software consultants who worked in the airline industry, creating and updating computer programs. During 2006 through 2008, they lived in Frankfurt, Germany, and contracted with Practical Business Services LTD, a British entity, to provide services to Lufthansa Airlines. Paula Byrd directed Practical Business Services to send her compensation, totaling \$428,185, to bank accounts in Switzerland titled in the name of David Byrd. David Byrd directed Practical Business Services to send his compensation, totaling \$508,313, to an American bank account titled in the name of David Byrd. They completely omitted Paula Byrd's income and failed to disclose David Byrd's ownership of foreign bank accounts on their 2006, 2007, and 2008 federal income tax returns. The Byrds'

evasion was revealed as a result of treaties negotiated by the United States with Switzerland, which had previously declined to provide information to American law enforcement authorities.

U.S. Attorney Nancy Stallard Harr and IRS Special Agent in Charge Tracey D. Montano noted the importance of the treaties with Switzerland and other countries regarding the use of foreign bank accounts to thwart

federal income tax collection and pledged to use all lawful means to identify and prosecute those who evade taxes by concealing income in offshore bank accounts.

This investigation was conducted by IRS - Criminal Investigation. Assistant U.S. Attorney Helen Smith represented the United States.

2016 Director's Community Leadership Awards

Local Leaders Honored at FBI Headquarters

Recipients of the 2016 Director's Community Leadership Awards with Director Comey

Recipients of the 2016

Director's Community Leadership Awards were honored in a ceremony at FBI Headquarters in Washington, D.C.

FBI Director James Comey today formally recognized 58 individuals and organizations from around the country for their efforts to build stronger, safer, and more cohesive communities.

"This is one of the very best days in the life of this organization," Director Comey said during the April 28 ceremony at FBI Headquarters in Washington, D.C. "We get to recognize and thank people who made the FBI better and the country better."

The annual Director's Community Leadership Awards ceremony will be held at the FBI Academy in Quantico, Virginia. **FBI ctd. pg. 5**

Now Hiring
Landscape Install Team Member
 Landscapes & Gardens by Pam is a full-service landscape install, construction, and maintenance company. Looking for motivated, hard-working, and customer-service based people. We have immediate full-time openings in the company that will allow for growth and promotion. We are a high quality, customer-service based company with full-time work available, based on weather conditions.
 Experience in landscaping is a plus, but a willingness to learn and the ability to work in a team environment is of the utmost priority. Typical work week is 40-50 hours Monday - Friday, with time and half for any hours over 40.
 Requirements:
 Must have a valid's driver's license
 Must be able to pass a drug test
 Must have dependable transportation to and from work
Call 865-806-8992

Reward Offered
 "We are offering \$200 for the return of our baby's clothes and toys or any information that leads to their return. We had them stored in storage unit 51 at crossroad mini storage, which is located at Eatons crossroads across from waldrops. They are all we have left from when she was little. We won't ask any questions or be angry. Just please bring them back. For any information contact 865-566-7638 or amandaroberts771@gmail.com" Thank you.



Cumberland Sail Bending Co

865-986-3733

HACIENDA Ayala's
Mexican Restaurant
 Market Dr. * Lenoir City (In Front of Food City)

Real Authentic Mexican Food at Affordable Prices **Outside of Mexico City!!!**

BEST MARGARITA

You've Tried The Rest Now Come Have The Best!!!

We Accept ALL Competitors Coupons

986-3553

The Collision Center Inc., is locally owned and operated by **Stan Ledbetter** and **Jake Tillett**. Along with their staff, they have over 136 years of combined experience in the collision repair business.

After working for *Knoxville Collision Center* for years before it was sold to an out of state corporation, Stan and Jake have fulfilled their dreams of owning and running their own shop.

"We are a family of past co-workers who have been together for 15 years. We support ALL our military and are ALL VOL! Stop by and see us and you will know with us **"Quality is not an option it is the only standard we will accept."**

The Collision Center, Inc.
 10439 Lexington Drive
 Knoxville, TN
865-288-7919



Wreck

Teonna Russell, 46, Butler Mill Road Madisonville, was charged with DUI, Simple Possession x4, Violation of Implied Consent, and Legend Drug. Deputy Craig Brew-

er LCSO, responded to Big Hill Road to a report of a non injury accident. upon arrival Deputy came in contact with the driver Toenna Russell, who Deputy noticed while speaking with her she had slurred speech,

and very animated about her movements. On asking for her DL. she could not find it on her which she had in her hand 2 different times, on getting out of the vehicle, she was unsteady on her feet and used the vehicle

to prop up on. Russell did poorly on sobriety test. She stated that she had taken a couple of Xanax earlier in the afternoon. Russell was placed under arrest. On checker her purse Deputy found 1 yellowed

colored container with, 7Alprazolam, 5Tramadol, 1 Amphetamine salt, 1 piece of methadone tablet corner and powdered Methadone tablet, and 21 Gabapentin.

FBI ctd. from pg. 4

Awards were launched in 1990 as a way to spotlight individuals and organizations for their work in combating crime, drugs, terrorism, and violence. Today's recipients were also recognized for their work in bridging the relationships between law enforcement agencies and the communities they serve, developing strategies to battle the nation's opioid crisis, and assisting victims of human trafficking, among other efforts.

Honorees are nominated by each of the FBI's 56 field offices, as well as the Bureau's Office of Public Affairs and the Criminal Justice Information Services Division.

In his remarks, Director Comey said this year's recipients embodied the words attributed to the 16th century minister John Wesley, who said, "Do all the good you can. By all the means you can. In all the ways you can. In all the places you can. At all the times you can. To all the people you can. As long as ever you can."

The Director related a story about speaking to young audiences and warning them against losing sight of what really matters in life. He would ask them to close their eyes, imagine they were old, and then ask

see FBI conc. pg. 7

PURDY'S AUTO PARTS AND SALVAGE
WE BUY SCRAP IRON • COPPER • BRASS • ALUMINUM

\$

7

Complete Cars
 per 100 lbs.

You Name It, We Buy It!
 Radiators, Wheels, Batteries, Appliances, Farm Equipment

Copper

Paying Top \$\$\$

Call For Latest Prices

Scrap Metal

up to

5

per 100 lb

We Buy Batteries

Aluminum Cans

Paying Top \$\$\$

Call For Latest Prices

You Call We Haul!

423-519-5402

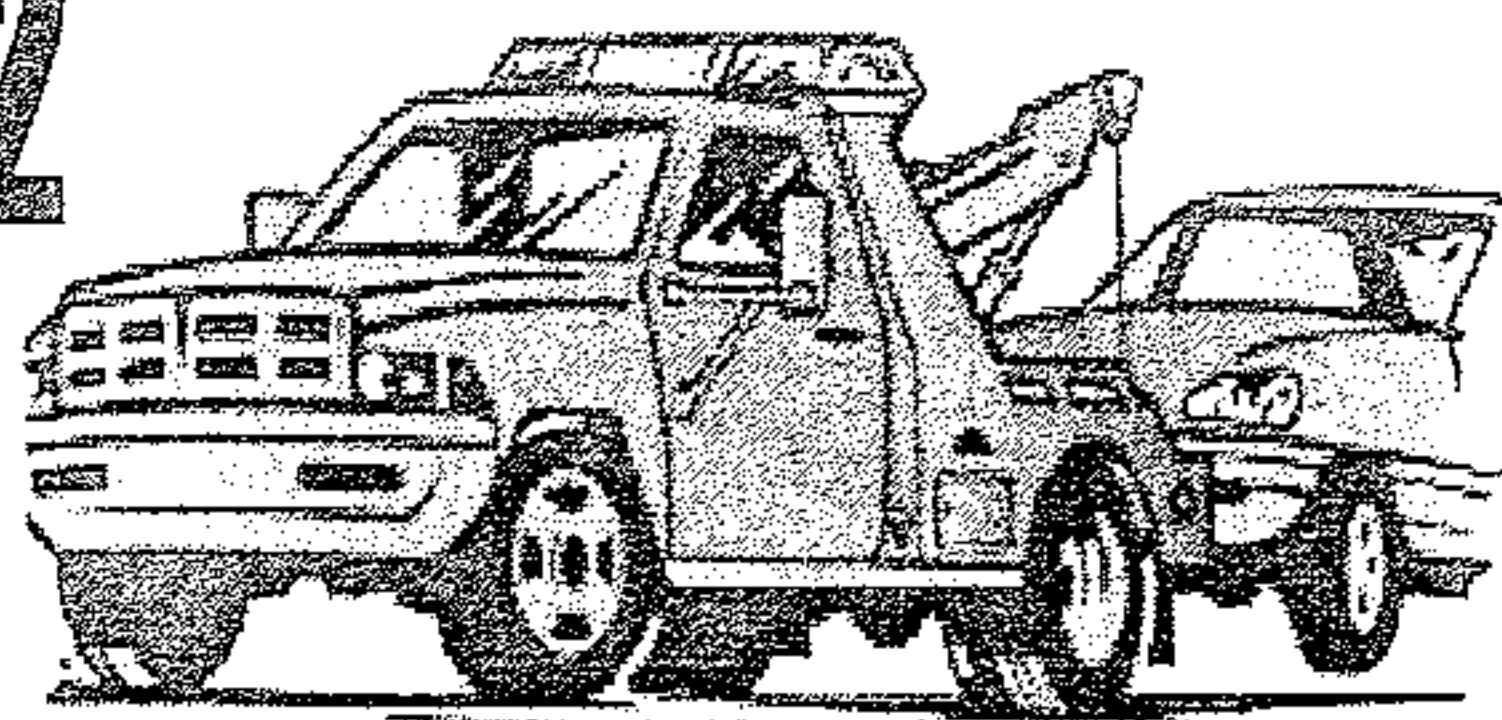

Prices subject to change with the market.

423 337-3977

149 County Road 323 Sweetwater

**Now Selling
 Aftermarket
 Body Parts at
 Discount Prices**

Prices subject to change with the market.

DUI

Melinda Majors, 52, Kiler Road Sweetwater, was charged with DUI, and Driving on revoked / Suspended License. Officer Tony Parks LCPD, was dispatched to a possible DUI driver at the McDonalds parking lot. Officer witnessed Melinda Majors leaving the McDonalds, and he pulled behind her and activated his emergency equipment. Majors did not respond and drove off at an extremely slow speed. Major stopped at the stop sign and stopped in the middle of the road and then proceeded to the Ingles parking lot where she stopped sideways in the parking lot. Upon approaching and talking with Ma-

jors Officer observed a strong alcoholic odor coming from her person. Officer ask her to turn the vehicle off. Major stated to Officer she had not been drinking. Officer noticed she was unsteady on her feet slurred speech, and eyes were very red. Officer ask her to perform sobriety test which she did poorly on. Majors was placed under arrest.

meth ctd. from pg. 3

his mouth. Langley then opened his mouth and spit out a small plastic bag with a green leafy substance in it believed to be marijuana. Deputy located a pipe and a baggie with a clear crystal substance believed to be methamphetamine, and rolling papers in his pocket. A

check of Langley's license revealed them to be suspended. Langley was placed under arrest.

FBI conc. from pg. 5

themselves: Who do I want to have been? "I know some of you want to have been people who made a difference

for those who needed you," he would tell the kids, "to have been people who chose lives of moral content, who stood there for the bullied and the picked on and the frightened."

"Why am I telling you this?" Comey asked on Friday. "This auditorium is filled with peo-

ple who have already answered the question in the most remarkable way. You will have been those people. We're here today to thank you for being that. Because of you, the FBI is better. Because of you, the United States of America is better."

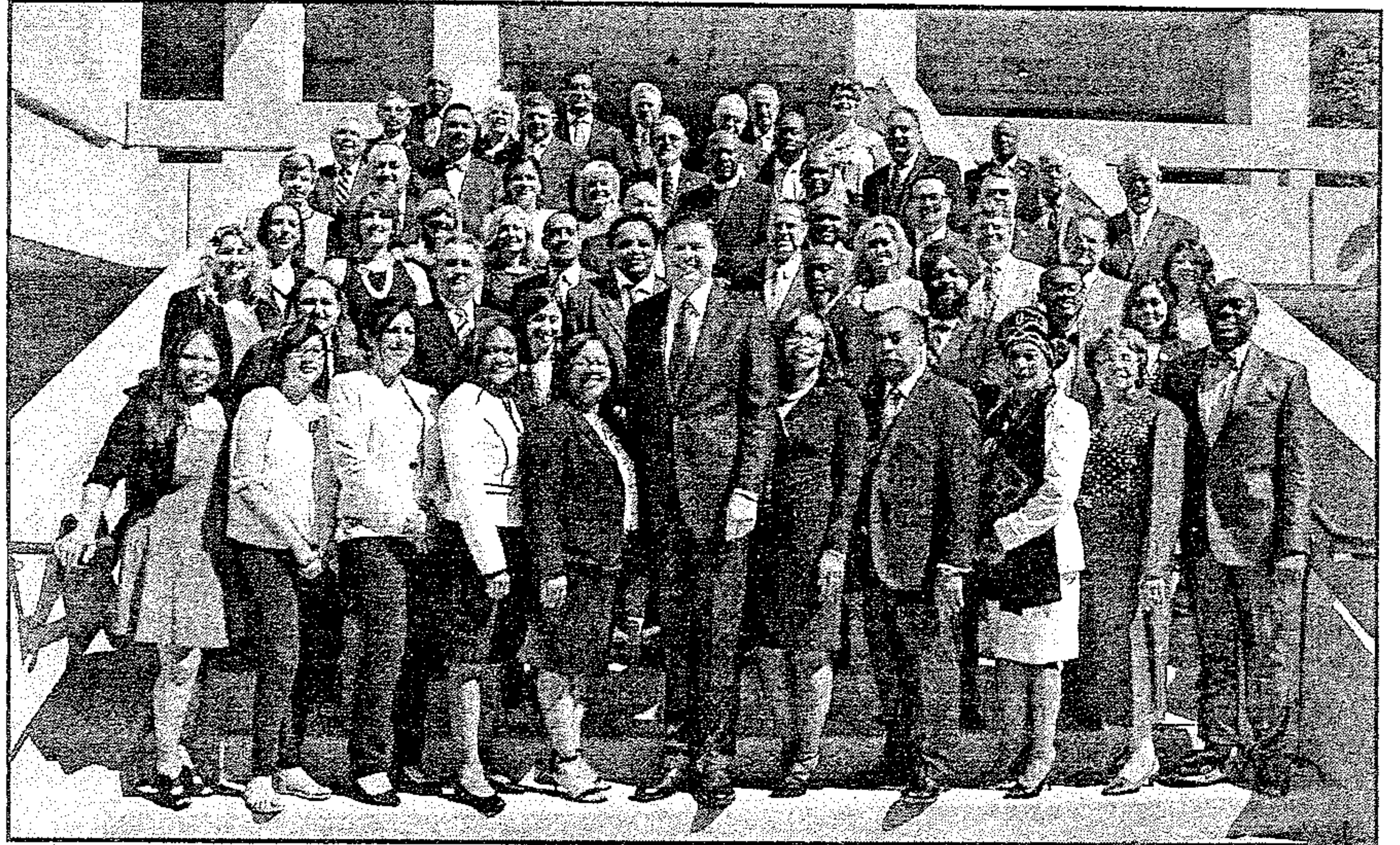

STAINED INC

TATTOO & PIERCING

LENOIR CITY 865 816-6440

NEW OWNER • NEW ARTIST • SINCE 2011

521 Hwy 321 next to Vape & Stuff & Inn Of Lenoir!

Clean-Affordable-Quality-Custom

Tattoo's You've Always Wanted!

BRING IN THIS AD FOR **\$25 OFF**
NEW INK FOR NEW CUSTOMERS ONLY!

Check us out on FB.com/
Stained.Inc.Tattoo/
www.STAINEDINC.com



Pennie Lindsey
Affiliate Broker



River Rock Real Estate Group

www.RiverRockTN.com

Pennie@riverrocktn.com

865-755-5264 - Cell

865-635-9706 Ext. 2 - Business

A Name You Already Know And Trust Just Got Even More Dependable
DEPENDABLE AUTO SERVICE, LUBE AND TIRES
is Now Offering
Expert, Affordable Transmission Service

All ASE Certified Technicians

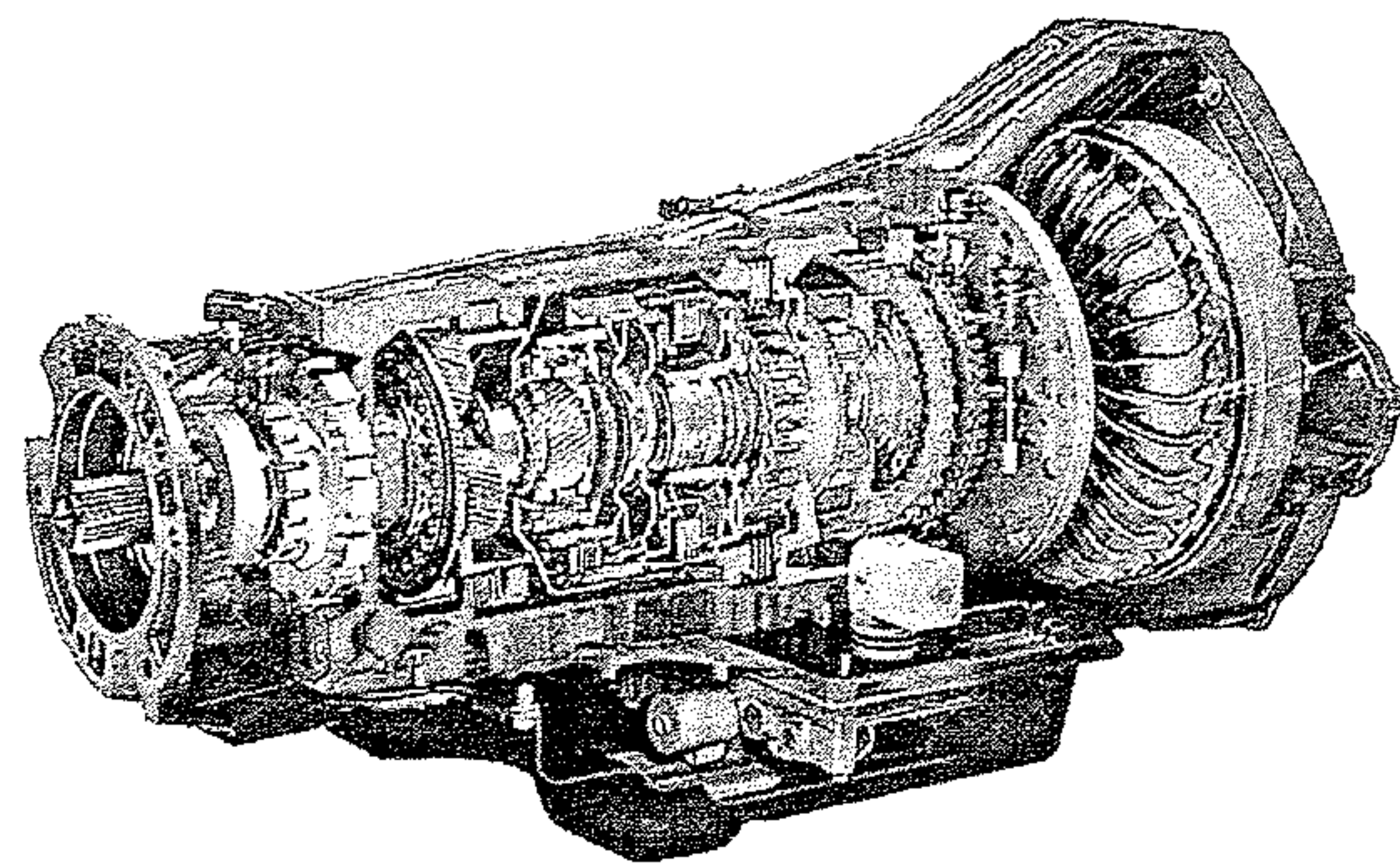

We proudly welcome all New Customers and Former Advanced Transmission Customers with a 10% Discount and Any Transmission Service or Repair*

865-986-9359

865-986-5050