

# The Daily Edition

50¢

Serving Loudon, Monroe and Surrounding Counties

Wednesday, May 17, 2017

## Two for one at Walmart! Two arrests made after thefts

(see theft pg. 2)



Angela Resser



Jeffery Miller

## Domestic charge for man after hitting truck

Man falls into officer in Loudon

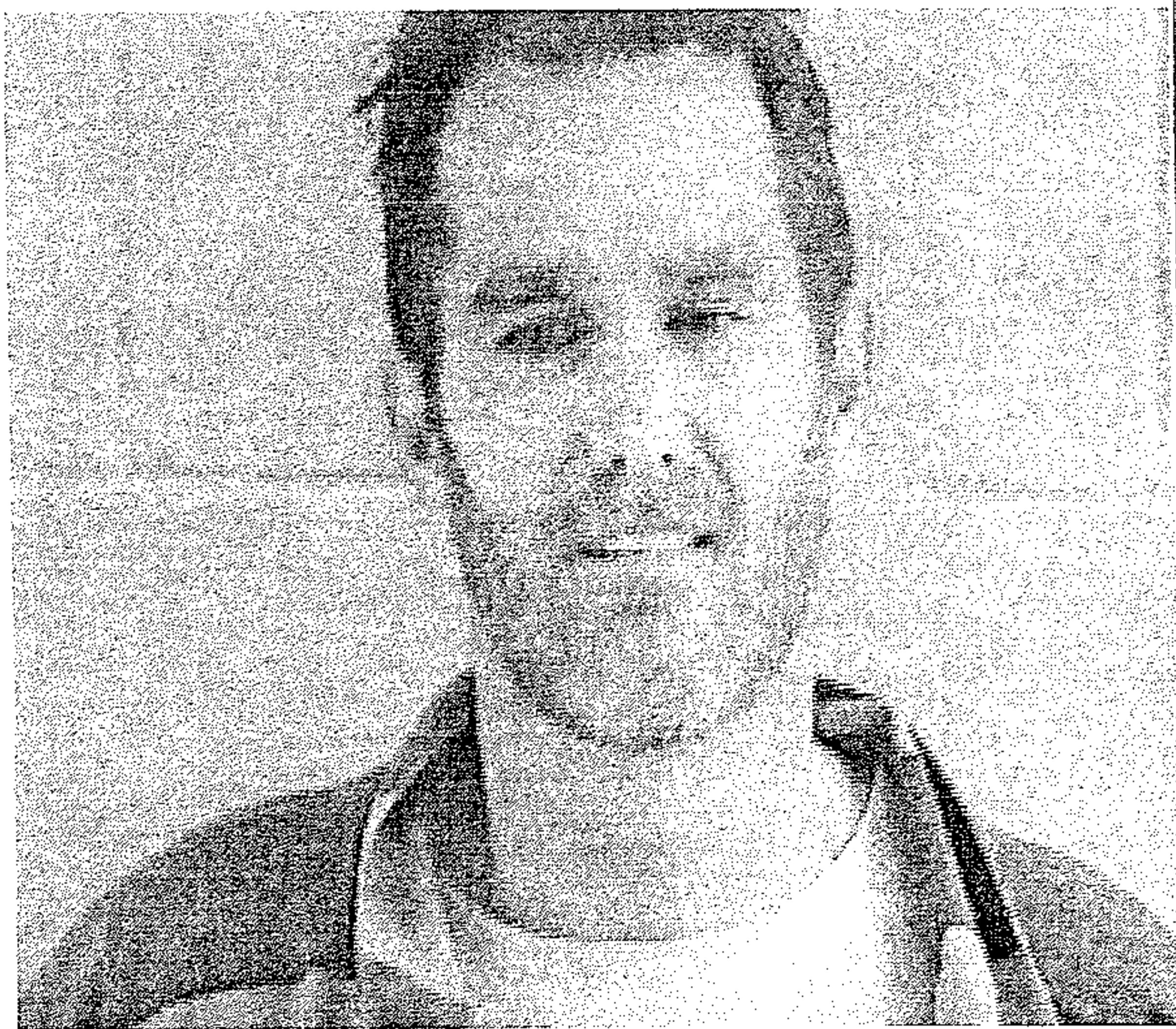

Jason Donaldson

see domestic pg. 5

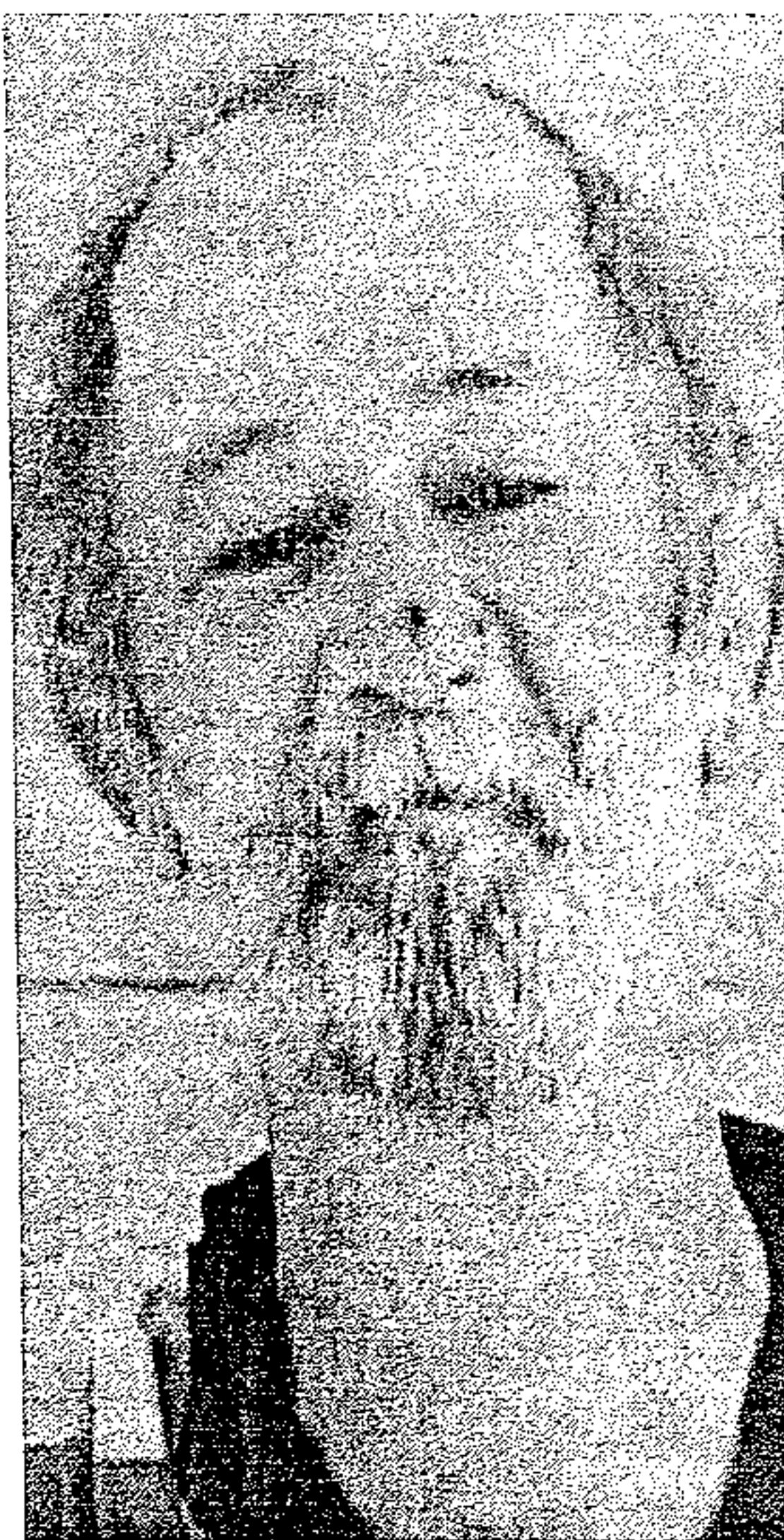

Jerry Clark

see PI pg. 7

## Generation: Millennials



American Legion Post 256 Commander presents guess speaker President, Hiwassee College, Dr. Robin Tricoli with the Legion "Thank You" coffee cup for her informative presentation.

see legion pg. 3

## Hogan's Alley Turns 30

The Evolution of the FBI's Mock Training Ground

It has been called the nation's most crime-ridden town and even the crime capital of the world, but no one has ever been victimized there. This town isn't listed on any official map, but it is visited nearly every day and appears often in the movies and on television.

Hogan's Alley is no ordinary place. It's a mock town where new

FBI agents and their law enforcement partners learn the ropes through a series of realistic and often stressful scenarios. Whether investigating criminal and terrorist activities, gathering intelligence, processing evidence, getting into simulated gun-fights, or making arrests, agents and other trainees are taught the latest techniques and

(see FBI pg. 4)

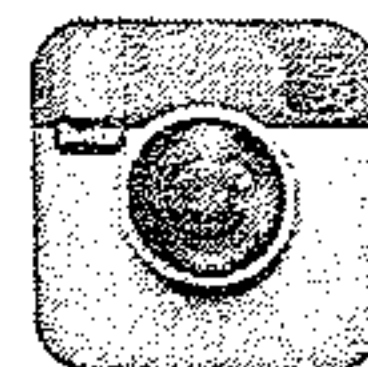

Follow us on Instagram



LIKE US ON

facebook

### Verse of the Day

While they were worshipping the Lord and fasting, the Holy Spirit said, "Set apart for me Barnabas and

Saul for the work to which I have called them." — Acts 13:2

### Obituaries

see inside Wazzup

It appears the cold is finally behind us... we

hope. It's sunny days and warm evenings great for camping!

### Weather

Today: Sunny, along with a few afternoon clouds. High 89F.

Tonight: Partly cloudy skies. Low near 65F.

Thursday Partly cloudy early. Scattered thunderstorms developing in the afternoon. High 86F. Thursday Night Partly cloudy during the evening with thunderstorms becoming likely overnight

(Continued on page 6)

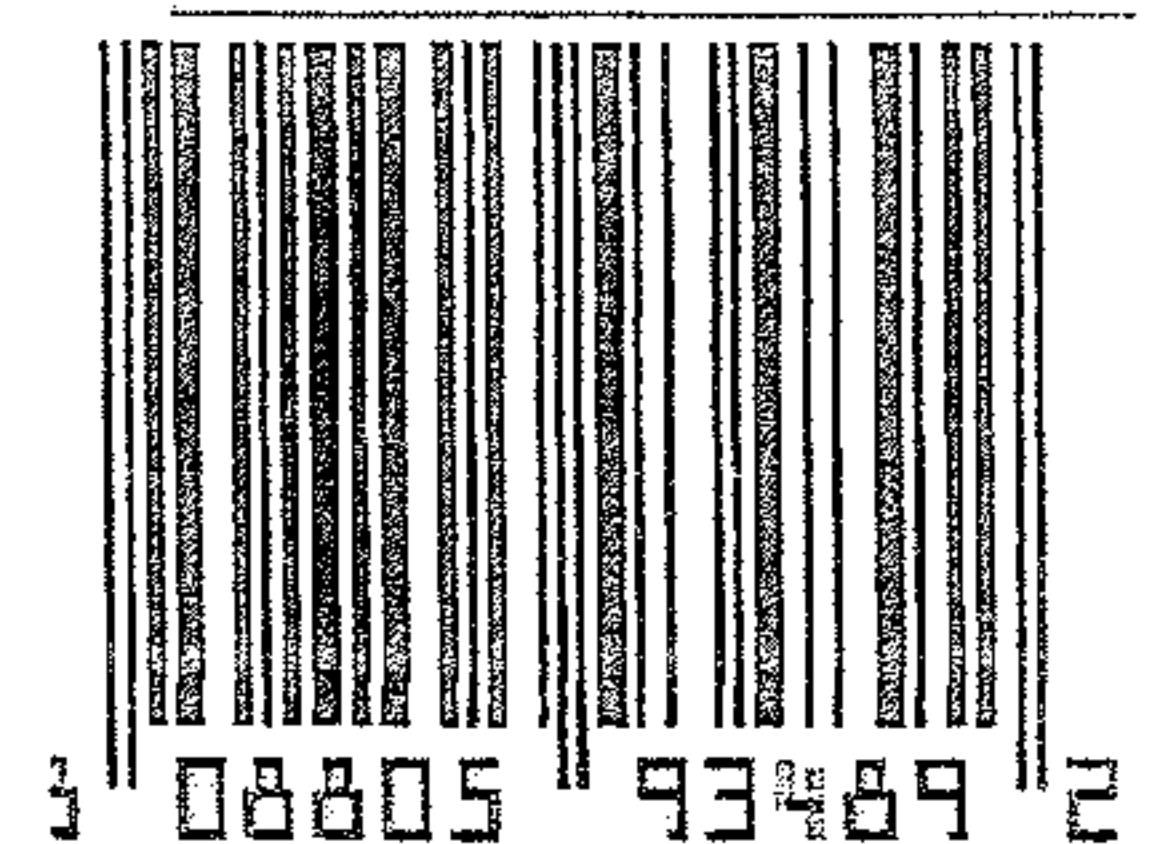

3 08805 93489 2



## Help Wanted Drivers Needed

Malones Wrecker Service

must have "F" Endorsement on driver license

Call 986-0051

## NEED HELP WITH INCOME TAX? PROFESSIONAL TAX SERVICE

**PRICE - 95% of returns between \$60-\$140**

(No Coupons Required)

**LOCALLY Owned & Operated - Open Year Round**

**30+ Years in the business**

**ALL Preparers with 10+ years experience**

**Pro Tax**

**111 E. Broadway  
Lenoir City, TN 37771  
Phone 865-986-4035**

\*US Armed Service Active Duty Personnel, "THANK YOU", Tax Return Free

### theft

Angela Resser, 37, E Broadway Lenoir City, was charged with Theft of Property, and Criminal Trespass.

Jeffery Miller, 40, Par-due Lane Lenoir City, was charged with Driving on Re-

voked/Suspended License, and Theft of Property. Jeffery Miller was at Walmart with a female identified as Angela Reeser, loading a shopping cart full of items. Jeffery left the store with a bag and a bear

(see theft ctd. pg. 3)

Notice: The Daily Edition does not knowingly accept fraudulent or misleading materials. The Daily Edition cannot guarantee the validity of offerings or statements contained herein. All liability for the contents of all advertising, and for any claims that may arise therefrom, is the responsibility of the advertiser or its agency. The Daily Edition reserves the right to reject, edit, or abbreviate any advertisement submitted. Advertising is accepted with the understanding that all liability for all copyright violations is the sole responsibility of the advertiser.

Photographs, artwork and other copy submitted for publication is considered the sole property of the advertiser. The Daily Edition will make every effort but will not be liable for failure to publish and ad or for typographical and layout errors. All statements and information about highlights featured items, letters to the editor, herein are those solely given to the interviewer or writer and the Daily Edition assumes no responsibility of the accuracy or validity thereof. The Daily Edition will gladly reprint at no charge that part of an advertisement in which an error occurs provided a claim is made within 3 days of the first publication of the ad. Information contained in the Wazzup is received anonymously and the Daily Edition assumes no responsibility for information and reserves the right to edit or reject any and/or all submissions. The Daily Edition is a daily newspaper of general circulation in Loudon County defined under TCA 2-1-104(a)(13).

The Daily Edition also serves Monroe, Knox, Anderson, Roane and Blount counties and serves 30,000 readers weekly. Send mail to PO Box 1240, Lenoir City TN 37771. 865-771-2249. email: dan1204us@yahoo.com

The Daily Edition is Loudon County's premier public interest and paid advertising paper. The Daily Edition is produced and published daily Monday through Friday and is circulated throughout Loudon County and parts of Monroe and Knox Counties. Display advertising rates \$5.00 per column inch and quantity discounts available. Call for information on upcoming promotions and events.

## Good Credit OK • Bad Credit OK • Bankruptcies OK • Repo OK \*



2007 Toyota FJ Cruiser Luggage Rack, Tow PKG, New Tires, V6, Auto, Immaculate



2013 Nissan Altima 3.6 V6, PS, PW, PL, 75k, Like New, Auto, Push Star



2012 Jeep Liberty Alloy Wheels, Luggage Rack, V6, Auto, A/C, Low Miles, Back-Up Camera

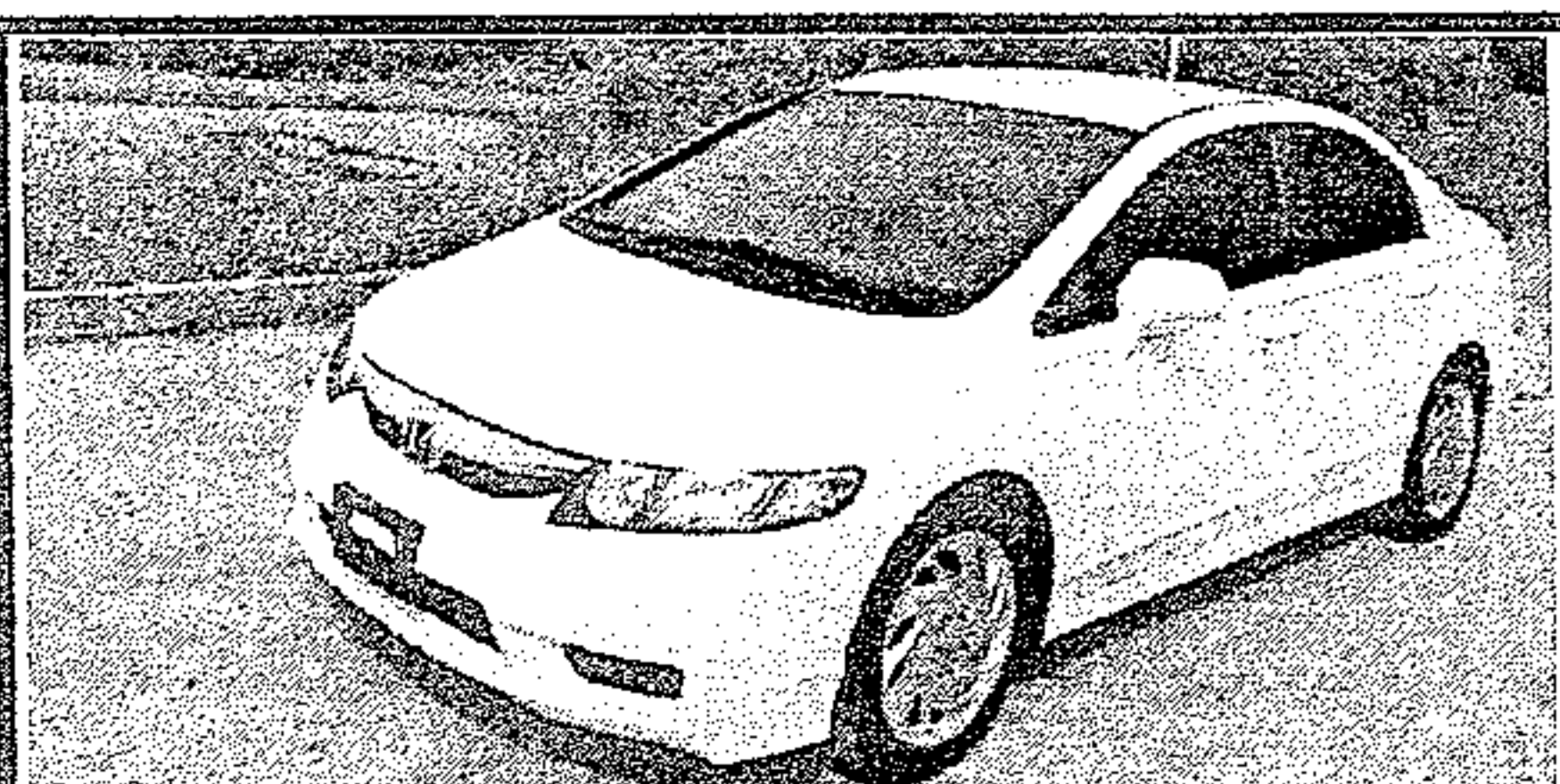

2011 Honda Civic Auto, Sporty, Gas Saver, AC, PW, PL, Tow PKG, Low Monthly Payments

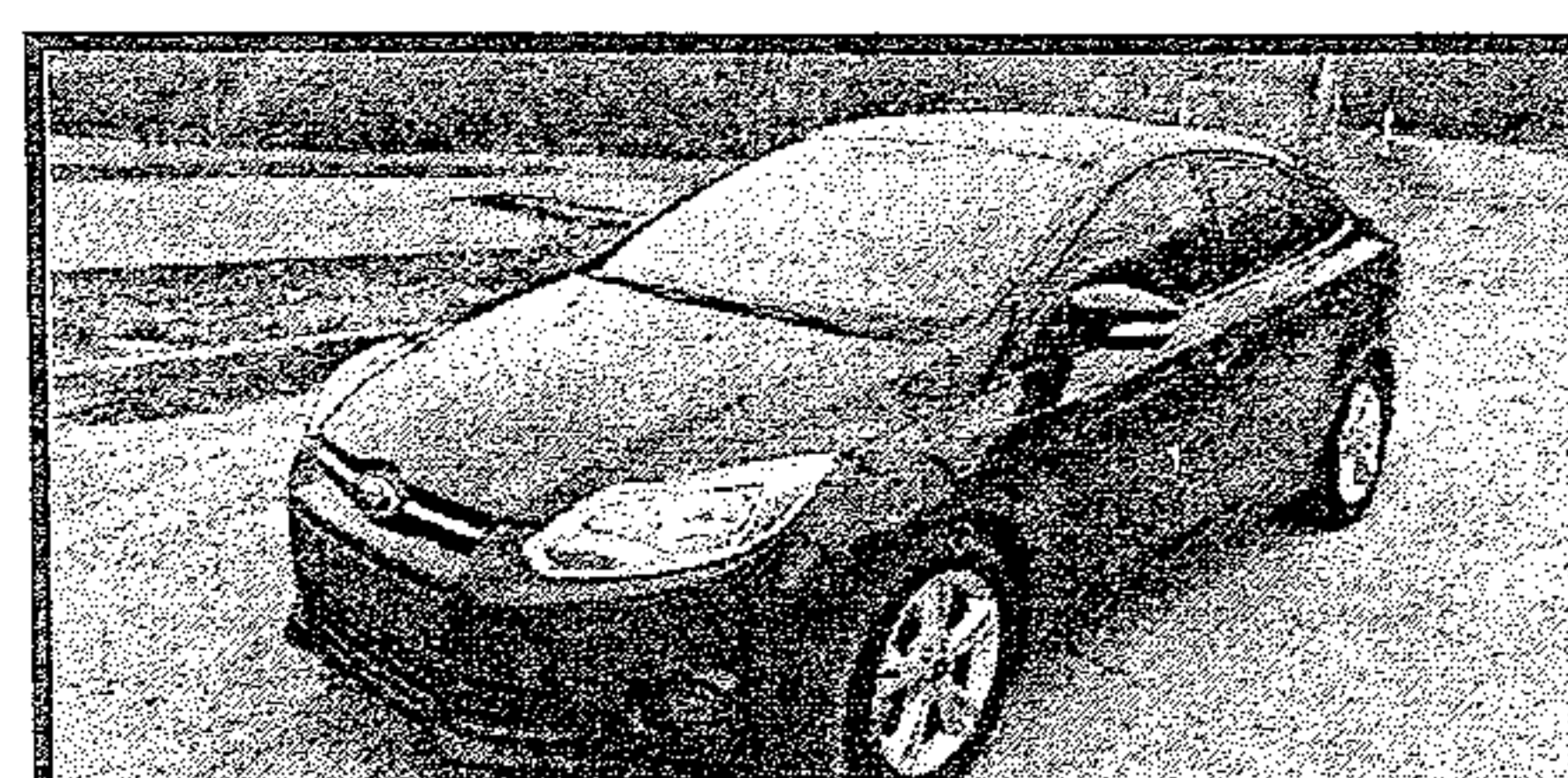

2014 Ford Focus 55k, Alloy Wheels, 5 Speed A/C, PW, PL, Sunroof, Factory Warranty



2014 Chevy Captiva 49k, PS, PW, PL, V6, Auto, Alloy Wheels, Luggage

# DEPENDABLE MOTORS 986-9343

803 E. Broadway • Lenoir City

Serving Loudon County for 20 Years

\* WAC. See Dealer for details

Visit our website at: [www.dependablemotorslc.com](http://www.dependablemotorslc.com)



**Legion**

As guest speaker, her topic was the Millennial generation. Dr. Robin Tricoli is most qualified to explain to the Legion members the definition and the positive traits of the Millennial generation. Her extensive background in strategic planning and business continuity planning allows her the knowledge and background to

present statistics detailing how Millennials are perceived. Millennials are the culture born between the late 70's thru the late 90's. We all need to understand this generation for they grew up in an electronics-filled and increasingly online and socially-networked world. As the most ethnically diverse generation Millennials tend to be tolerant of difference.

Having been raised under the mantra "follow your dreams" and being told they were special, they tend to be confident. The statistics Dr. Tricoli explained were very informative and can provide any organization with a better understanding of the last generation born in the 20th century. For more information about the American Legion contact Commander Vic Vickery or visit the Post 256 website: [www.Tellico-](http://www.Tellico-LakePost256.org)

[LakePost256.org](http://LakePost256.org)

theft ctd. from pg. 2

and placed them in the vehicle they were both in. Items totaling 180.14. Angela went to the self check out and skip scanned 184.54 worth of merchandise. Angela was stopped by loss prevention then took off running in front of Walmart where she was stopped. Sgt. Eddie Range LCPD, made the arrest.



**BIMBO'S**  
**Deli Open 24 Hours**  
**865-986-9643 Call Ins Welcome**  
**Specials**  
**Lg. Cold Sub, bag of chips and 16 oz. fountain drink only \$6.29**  
**Footlong Corn Dog \$2.59**

**West End Storage & Warehouses**  
**502 Ward Avenue • Loudon**  
**Call 865-458-4774 or 865-679-5555**



**T A T T O O**

**A Short Drive For A Lifetime Of Quality**

**Nationally Published Artist**  
**Brian Jones**

**Serving East Tennessee since 1996**

**Always 100% Health Score**

**Like Us On Facebook at**  
**Living art tattoo of tn**

**Open Late on Weekends**  
**Tues-Sat 1pm-9**  
**Sun & Mon by appt.**

**423-420-0380**

**Living Art Tattoo**  
**Madisonville**

**P I E R C I N G**

**C&J Towing and Recovery**

**LOWEST TOWING RATES AROUND!!!**

Have you been overcharged for any type of towing service in the Lenoir City area? If you have a breakdown or accident please OWNER REQUEST C&J Towing with the officer. Also please call your Sheriff and ask him to place C&J Towing on the "Rotation List\*" and help other motorists save as much as you did! We at C&J are locally owned and operated, State approved, licensed, bonded and insured. Call and let us know if your denied service or how we can be of assistance.

\*note: the "Rotation List" is a list of wrecker services that provide service for wrecks, DUI's, breakdowns, etc. and are on an on-call basis for service. This list is approved by the Sheriff.

**Cliff Teeters • Owner**  
**865-809-1661**

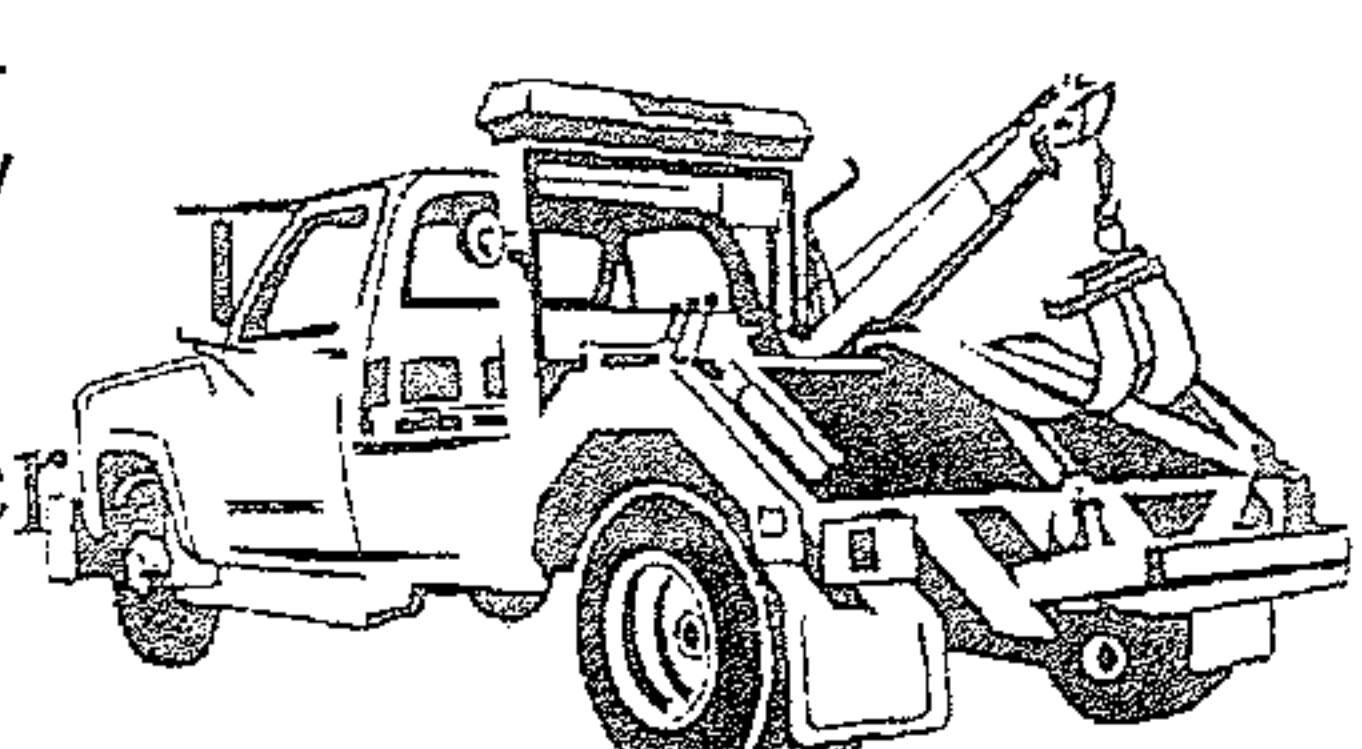



**FBI**

challenged to make the right decisions—with the help of actors playing criminals, victims, and bystanders.

This year, Hogan's Alley celebrates its 30th anniversary on the grounds of the FBI's Training Academy in Quantico, Virginia. Over the years it has evolved into the cornerstone of the Bureau's practical training program. Every FBI agent hired over the past three decades has gained valuable, real-world experience in this tiny yet always bustling town.

The name—and the training concept—have actually been around quite a bit longer in law enforcement circles. Many decades ago, the use of fake storefronts with mechanical, pop-up bad guys were a staple of police firearms training. The first exercise of this kind appears to have been in 1919 at the U.S. Army's Camp Perry in Ohio on a set built to look like a war-torn French village. It was created for a firearms contest called the National

Matches and later used in police training sponsored by the Army. Contestants were scored on their shooting time and accuracy when hand-controlled cutouts of threatening persons were raised in

windows. Surprise target ranges were used at Hogan's Alley in the 1940s and 1950s. Cutouts of targets would mechanically pop up in windows and doors of these ranges and agents would have to

quickly react; they were scored on accuracy and response time.

By the mid-1920s, these training exercises came to be called "Hogan's Alleys." The name came from a comic strip in the 1890s called the Yellow Kid, which was a romanticized look at the daily life a young boy who lived in a crime-ridden New York tenement called Hogan's Alley.

In its early days, the Bureau used actors and mannequin victims from time to time in its practical exercises. The FBI began including "Alleys" in its training program in the 1940s. In 1945, it started building its first "surprise scenario" training range

that incorporated mechanically controlled cutouts. This first FBI Hogan's Alley cost the Bureau \$3,000, according to former Special Agent Larry Wack. By the early 1950s, Hogan's Alley took on further prominence in FBI training, becoming a centerpiece of Bureau plans to revamp its ranges. When completed, the new Alley included a row of false house fronts, 120 feet long and 10 feet high. Surprise targets appeared in windows along this street front, and agents chose whether or not to shoot.

In 1972, when the FBI opened its Training Academy in Quantico, new facilities

FBI ctd. pg. 5

**Now Hiring**

**Landscape Install Team Member**

Landscapes & Gardens by Pam is a full-service landscape install, construction, and maintenance company. Looking for motivated, hard-working, and customer-service based people. We have immediate, full-time openings in the company that will allow for growth and promotion. We are a high quality, customer-service based company with full-time work available, based on weather conditions.

Experience in landscaping is a plus, but a willingness to learn and the ability to work in a team environment is of the utmost priority. Typical work week is 40-50 hours Monday - Friday, with time and half for any hours over 40.

**Requirements:**

- Must have a valid's driver's license
- Must be able to pass a drug test
- Must have dependable transportation to and from work

**Call 865-806-8992**

**Reward Offered**

"We are offering \$200 for the return of our baby's clothes and toys or any information that leads to their return. We had them stored in storage unit 51 at crossroad mini storage, which is located at Eatons crossroads across from waldrops. They are all we have left from when she was little. We won't ask any questions or be angry. Just please bring them back. For any information contact 865-566-7638 or amandaroberts771@gmail.com" Thank you.

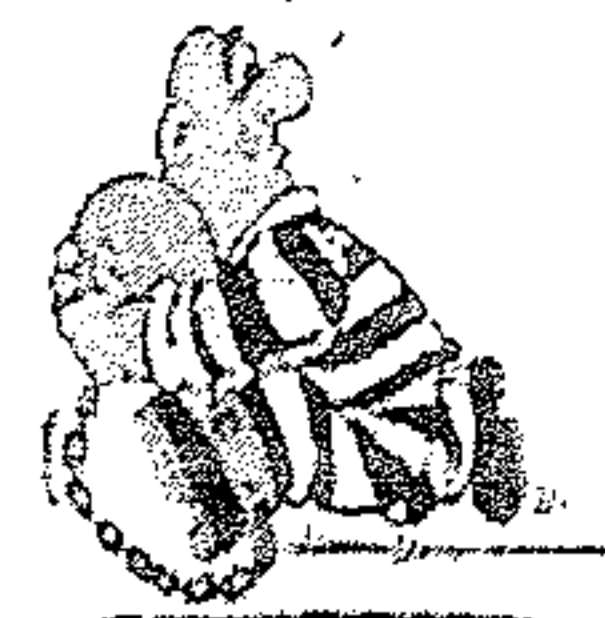

**Cumberland Bail Bonding Co**

**865-986-3733**

**HACIENDA Ayala's**

**Mexican Restaurant**

Market Dr. \* Lenoir City (In Front of Food City)

Real Authentic Mexican Food at Affordable Prices **Outside of Mexico City!!!**

You've Tried The Rest Now Come Have The Best!!!

**BEST MARGARITA**

We Accept ALL Competitors Coupons  
986-3553

**IT Director Wanted**

Loudon County Government has an opening for the position of IT Director. The IT Director manages and administers IT department resources to effectively meet the needs of Loudon County Government. For a full list of duties, responsibilities, and required qualifications for this position, please visit the job posting on the Loudon County Government website (<https://loudoncounty-tn.gov>) under "General Information > Employment". Interested candidates who meet the qualifications should contact the Loudon County Mayor's Office no later than 4pm on May 24, 2017



**Domestic**

Jason Donaldson, 44, Maple Hill Road Loudon, was charged with Domestic Assault.

Deputy JC Schultz LCSO, answered

a physical domestic call at Maple Hill Rd in Loudon Tn. Upon arrival, the victim stated that her ex-husband, whom she still has sexual relations with and lives with part of the time start-

ed yelling and arguing when she began to pack her belongings to leave. Mr. Jason Bradley Donaldson is her ex-husband. Victim stated that she was in fear of Mr. Donaldson, and showed this

deputy a fresh dent (the dirt was wiped off the finish, and a dent was in the right side of the hood) in the hood of her white Dodge pickup. She stated that Mr. Donaldson kicked her tires and struck her

hood with his fist. She then added that she believed he placed a red bag with paraphernalia inside her truck. She turned over the paraphernalia for destruction. Mr. Donaldson stated that he had not been violent and they were trying to work out the problems in their relationship.

Mr Donaldsons juvenile son stated (without being asked) "you did kick moms truck and yell at us" when he heard his father say he did not hit moms truck. Mr. Donaldson was arrested and transported to the Loudon County Jail by Deputy Brewer.

FBI ctd. from pg. 4

were created for agent training. In the mid-1980s, the Bureau began constructing a new home for practical instruction—this time filled with actual buildings, including a bank, a motel, a jewelry shop, and a luncheonette. This new crime town was officially launched in 1987, and it has been a key staple of FBI training ever since.

Over time, the town has grown, adding warehouse facilities, single-family homes, and other typical places where Bureau agents might interact with the public and those who would prey on them. Hogan's Alley may have the highest crime rate in the world, but the Bureau's agent and police trainees have ensured that it also has the highest arrest rate, too.

**The Daily Edition**  
serving Loudon and surrounding  
counties since 1986

**PURDY'S AUTO PARTS AND SALVAGE**  
WE BUY SCRAP IRON • COPPER • BRASS • ALUMINUM

\$

**7**

**Complete Cars**

per 100 lbs.

*You Name It, We Buy It!*

*Radiators, Wheels, Batteries, Appliances, Farm Equipment*

**Copper**

**Paying Top \$\$\$**

**Call For Latest Prices**

**Scrap Metal**

up to

**5**

per 100 lb

**We Buy Batteries**

**Aluminum Cans**

**Paying Top \$\$\$**

**Call For Latest Prices**

**You Call We Haul!**

**423-519-5402**

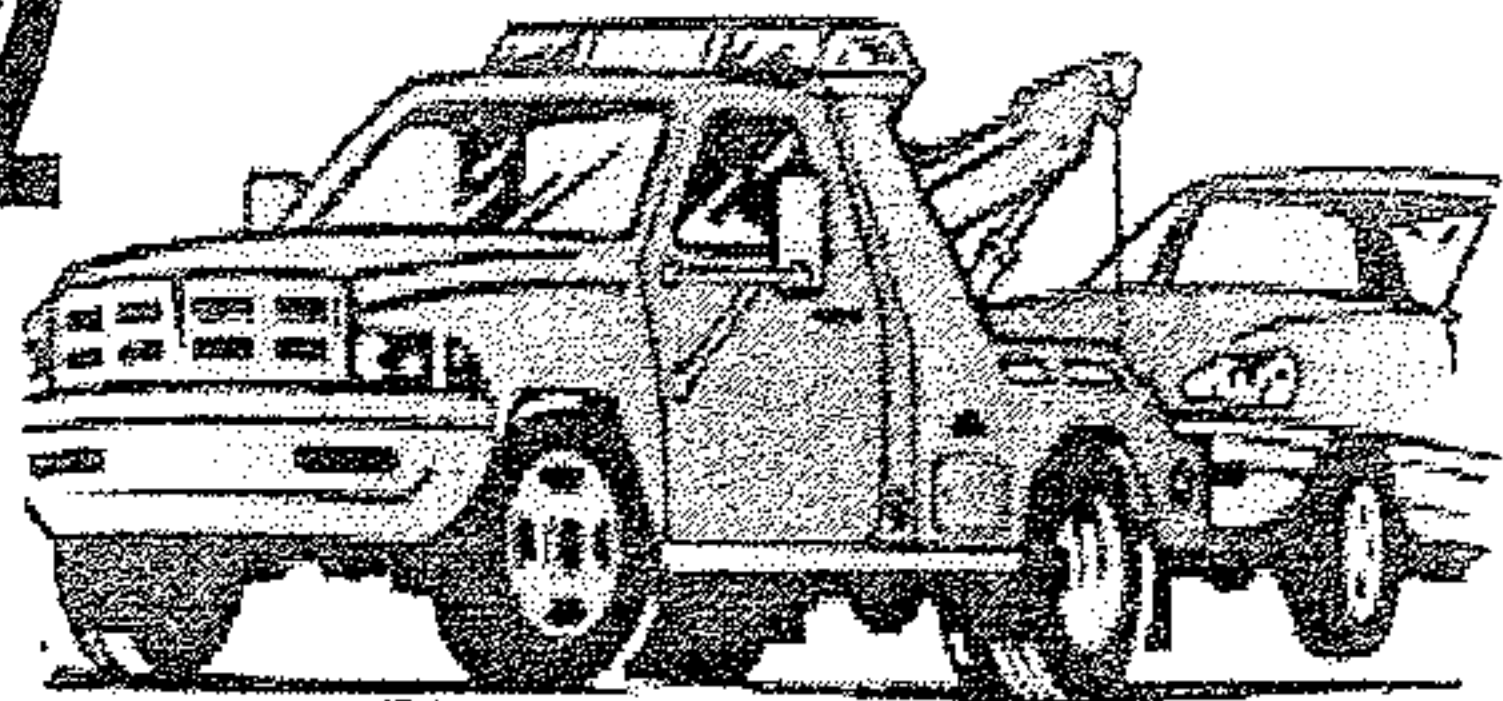

Prices subject to change with the market.

**423 337-3977**

**149 County Road 323 Sweetwater**

**Now Selling  
Aftermarket  
Body Parts at  
Discount Prices**

Prices subject to change with the market.



PI

Jerry Clark, 50, Reynoldsburg Road Springsville, was charged with Public intoxication, and Poss. of Drug Para. Officer James Cogdill LPD, observed a male stumble and fall in the parking lot at Cinco Amigos after making contact he identified the male as Jerry Clark. After speaking with Clark Deputy observed Clark to have slurred speech unable to stand on his own, and when ask for his ID, he was unable to get it out of his wallet. As Officer was speaking with Clark he stumbled and fell against the Officer. Clark was placed under arrest. Upon searching Clark Officer located

a glass pipe with what appeared to be a green leafy substance believed to be marijuana.

Luis Javier Martinez-Melo sentenced to 57 months in prison for participating in internet auto sales scam

On May 15, 2017, Luis Javier Martinez-Melo, 26, of Atlanta, Georgia, was sentenced by the Honorable Pamela L. Reeves, U.S. District Judge, to serve 57 months in federal prison for his role in a scheme to defraud victims involving an online automobile sales scam. Additionally, the court ordered him to pay restitution to the 66 identified

victims of the scheme whose losses exceeded \$674,000.

At the conclusion of his prison sentence, Martinez-Melo will be presented to U.S. Immigration and Customs Enforcement for deportation proceedings.

Martinez-Melo opened bank accounts in various bogus business names that were used to receive funds from victims who believed that they were buying cars advertised

for sale on various Internet websites. After the victims wired funds into these bank accounts, Martinez-Melo and others withdrew and wire transferred the funds to members of the scheme operating from overseas.

Martinez-Melo pleaded guilty in January 2017 to federal wire fraud and aggravated identity theft charges stemming from his role in the scheme.

The Federal Bureau of Investigation conducted this investigation. Matthew T. Morris, Assistant U.S. Attorney, represented the United States.

**Purdy's Auto Sales**  
Hwy 11 Sweetwater  
Buy Here Pay Here  
Cars, Trucks, Vans, SUVs

**Kelley's Tree Service**  
Free Estimates  
Fully Insured  
865-414-3014

**Estate Sale, 1217 Kahite Trail, Kahite Subdivision in Vonore, TN. May 18, 19 and 20. 8 until 3 each day. Very nice items...furniture, household items, dishes, tools and many garage items.**

**STAINED INK**  
**TATTOO & PIERCING**  
LENOIR CITY 865 816-6440  
NEW OWNER • NEW ARTIST • SINCE 2011  
521 Hwy 321 next to Vape & Stuff & Inn Of Lenoir!  
Clean-Affordable-Quality-Custom  
Tattoo's You've Always Wanted!

Bring In This Ad for **\$25 OFF**  
NEW INK FOR NEW CUSTOMERS ONLY!

Check us out on FB.com/  
Stained.Inc.Tattoo/  
www.STAINEDINC.com

**RIVER ROCK REAL ESTATE GROUP**



*Pennie Lindsey*  
Affiliate Broker

River Rock Real Estate Group  
www.RiverRockTN.com  
Pennie@riverrocktn.com  
865-755-5264 - Cell  
865-635-9706 Ext. 2 - Business

A Name You Already Know And Trust Just Got Even More Dependable  
**DEPENDABLE AUTO SERVICE, LUBE AND TIRES**  
**is Now Offering**  
**Expert, Affordable Transmission Service**  
All ASE Certified Technicians

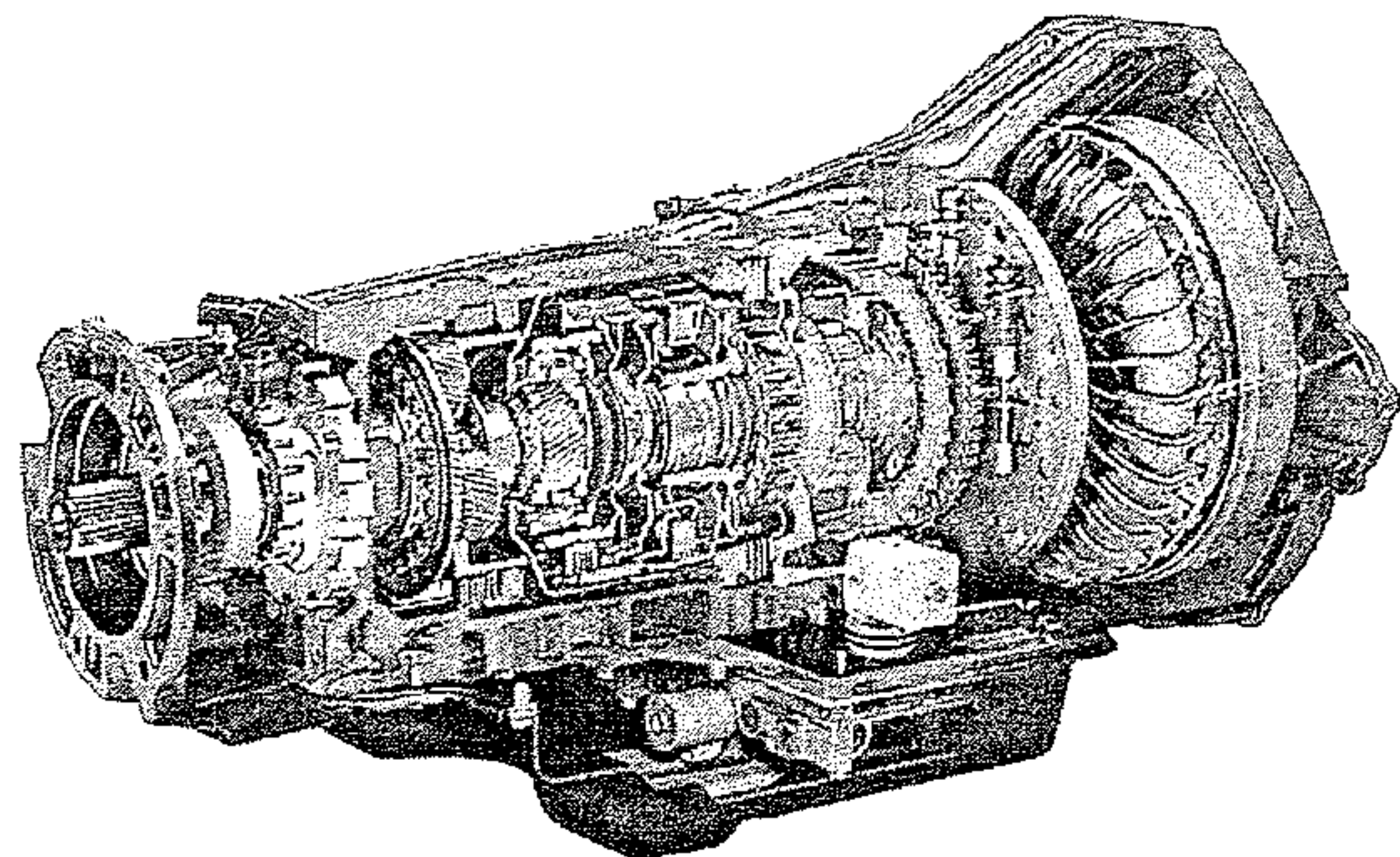

**We proudly welcome all New Customers and Former Advanced Transmission Customers with a 10% Discount and Any Transmission Service or Repair\***

**865-986-9359**

**865-986-5050**