

The Daily Edition

50¢

Serving Loudon, Monroe and Surrounding Counties

Monday, May 15, 2017

Mechanic charged with theft after selling customers truck

Tim Jackson, 43, Honysuckle Road Philadelphia, was charged with Theft of Property.

The victim reported that he had a 1999 green Ford truck that needed repairs. Victim hired Tim Jackson to repair the vehicle. Tim Jackson had the vehicle towed to his residence on Steekee Road around the 5th of April 2017. In the last thirty days victim has traveled to Mr Jackson (see theft pg. 2)



Tim Jackson

LCSO and THP team up in traffic stop



John Wallace

see team pg. 3

Over 3x the limit in DUI wreck in Loudon

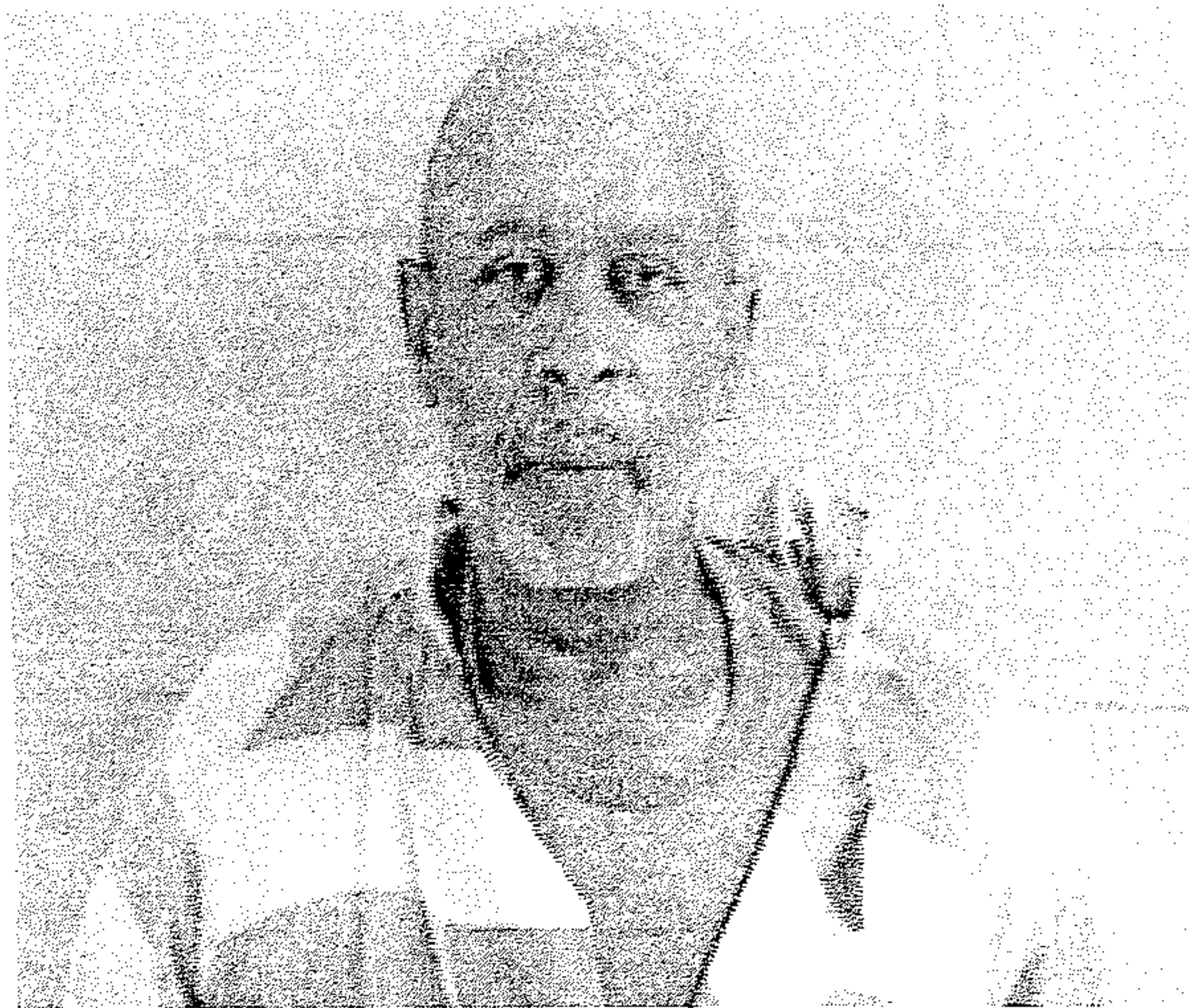

Harold Hawkins

see Wreck pg. 5

Charges filed after running red light

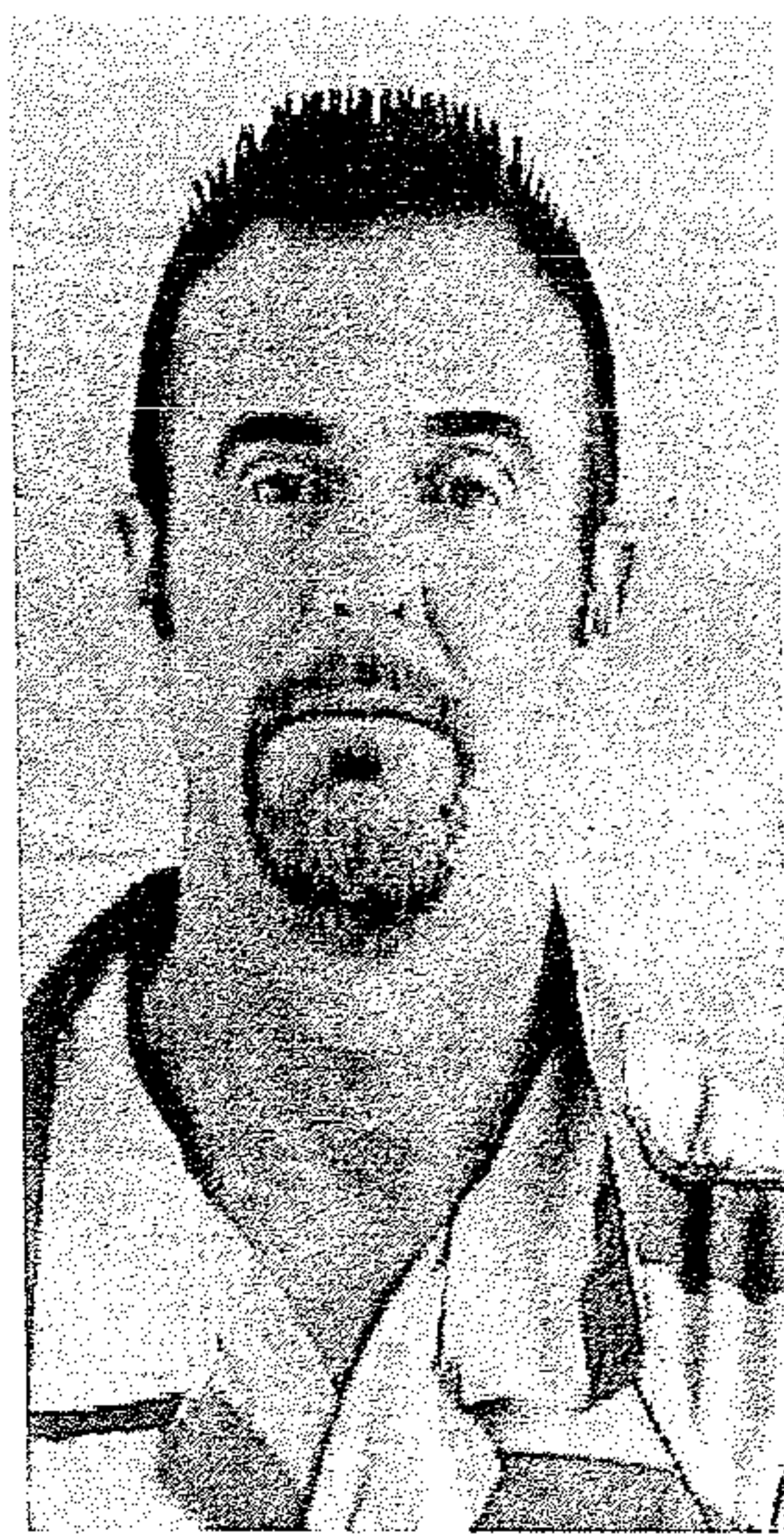

Milford Sexton

see charges pg. 7

Virtual Ticket to Prison Investigation of Fraud Scheme Unravels Man's Illegal Bitcoin Exchange

The beginning of the end of an Ohio man's venture into the murky world of cryptocurrencies can be traced back to the moment investigators linked the 29-year-old to a ticket-fraud scheme nearly 2,000 miles away in California.

Daniel Mercede, of Chagrin Falls, was charged last November for using stolen credit card information to

buy tickets to concerts and other events from a California-based ticket seller. He would then turn around and sell them through another ticket broker—often for less than he paid—netting himself a tidy illicit profit. Court documents show he collected more than \$400,000 in proceeds, beginning in 2014, through ticket sales and by stealing

(see FBI pg. 4)

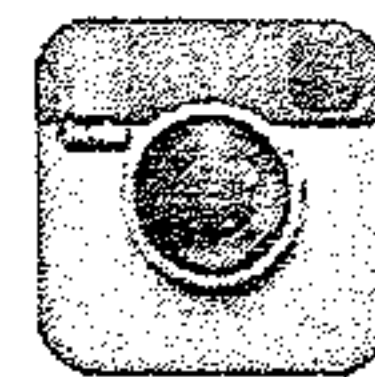

Follow us on Instagram



LIKE US ON

facebook

Verse of the Day

However, as it is written: "No eye has seen, no ear has heard, no mind has conceived what God has prepared

for those who love him." — 1 Corinthians 2:9

Obituaries

see inside Wazzup

Schools will be out soon so make great

plans for the summer and be sure to watch for walkers and bike riders on the roadways!

Weather

Today: Partly cloudy skies. High 83F.

Tonight: Partly cloudy Low 59F.

Tuesday Some clouds in the morning will give way to mainly sunny skies for the afternoon. High 88F.

Tuesday Night Mainly clear early, then a few

(Continued on page 6)

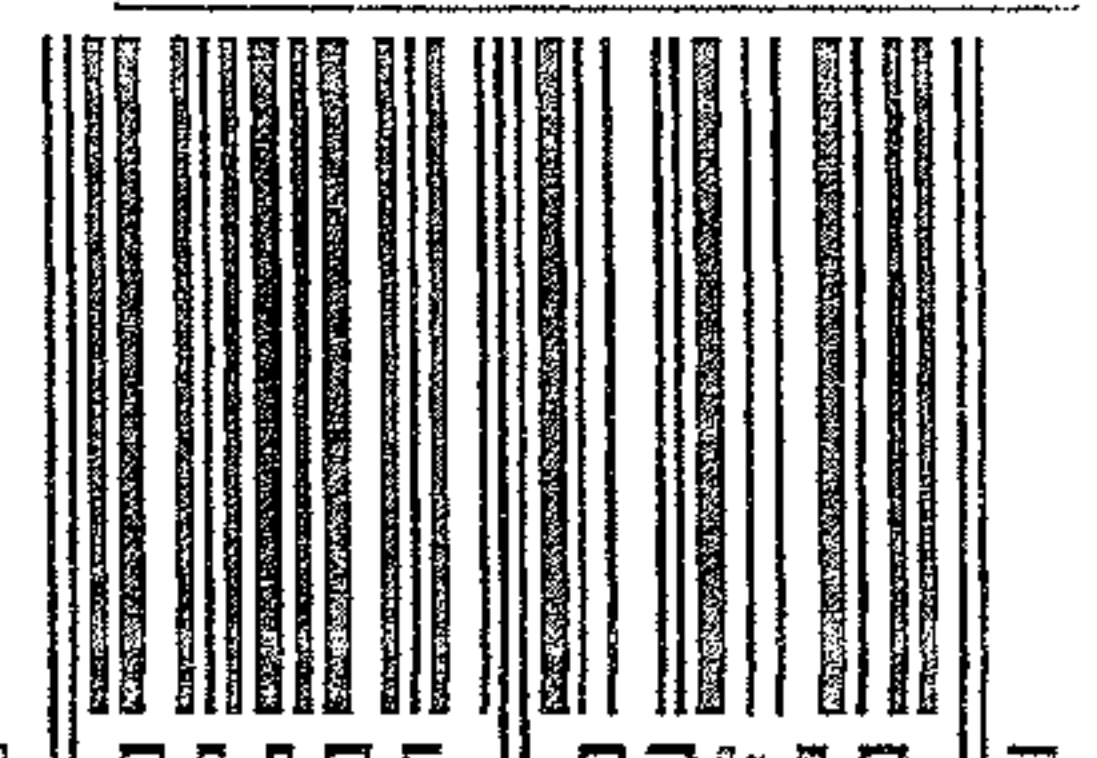

Help Wanted Drivers Needed

Malones Wrecker Service

must have "F" Endorsement on driver license

Call 986-0051

NEED HELP WITH INCOME TAX? PROFESSIONAL TAX SERVICE

PRICE - 95% of returns between \$60-\$140

(No Coupons Required)

LOCALLY owned & Operated - Open Year Round

30+ Years in the business

ALL Preparers with 10+ years experience

Pro Tax

111 E. Broadway

Lenoir City, TN 37771

Phone 865-986-4035

**US Armed Service Active Duty Personnel, "THANK YOU", Tax Return Free*

theft

residence a number of times trying to get information about his vehicle and was not able to speak with Mr Jackson but did speak to his son. The son was asked where was the truck and he said dad did something with it. Upon further investigation it

was discovered that Mr Jackson hired a male and traveled with him to Lankfords recycling in Sweetwater Tn and sold the vehicle without permission on April 20 th 2017. The Vehicle value is approximately 1200.00. This did happen in Loudon county Tn .

Notice: The Daily Edition does not knowingly accept fraudulent or misleading materials. The Daily Edition cannot guarantee the validity of offerings or statements contained herein. All liability for the contents of all advertising, and for any claims that may arise therefrom, is the responsibility of the advertiser or its agency. The Daily Edition reserves the right to reject, edit, or abbreviate any advertisement submitted. Advertising is accepted with the understanding that all liability for all copyright violations is the sole responsibility of the advertiser.

Photographs, artwork and other copy submitted for publication is considered the sole property of the advertiser. The Daily Edition will make every effort but will not be liable for failure to publish and ad or for typographical and layout errors. All statements and information about highlights featured items, letters to the editor, herein are those solely given to the interviewer or writer and the Daily Edition assumes no responsibility of the accuracy or validity thereof. The Daily Edition will gladly reprint at no charge that part of an advertisement in which an error occurs provided a claim is made within 3 days of the first publication of the ad. Information contained in the Wazzup is received anonymously and the Daily Edition assumes no responsibility for information and reserves the right to edit or reject any and/or all submissions. The Daily Edition is a daily newspaper of general circulation in Loudon County defined under TCA 2-1-104(a)(13).

The Daily Edition also serves Monroe, Knox, Anderson, Roane and Blount counties and serves 30,000 readers weekly. Send mail to PO Box 1240, Lenoir City TN 37771. 865-771-2249. email: dan1204us@yahoo.com

The Daily Edition is Loudon County's premier public interest and paid advertising paper. The Daily Edition is produced and published daily Monday through Friday and is circulated throughout Loudon County and parts of Monroe and Knox Counties. Display advertising rates \$5.00 per column inch and quantity discounts available. Call for information on upcoming promotions and events.

Good Credit OK • Bad Credit OK • Bankruptcies OK • Repo OK *

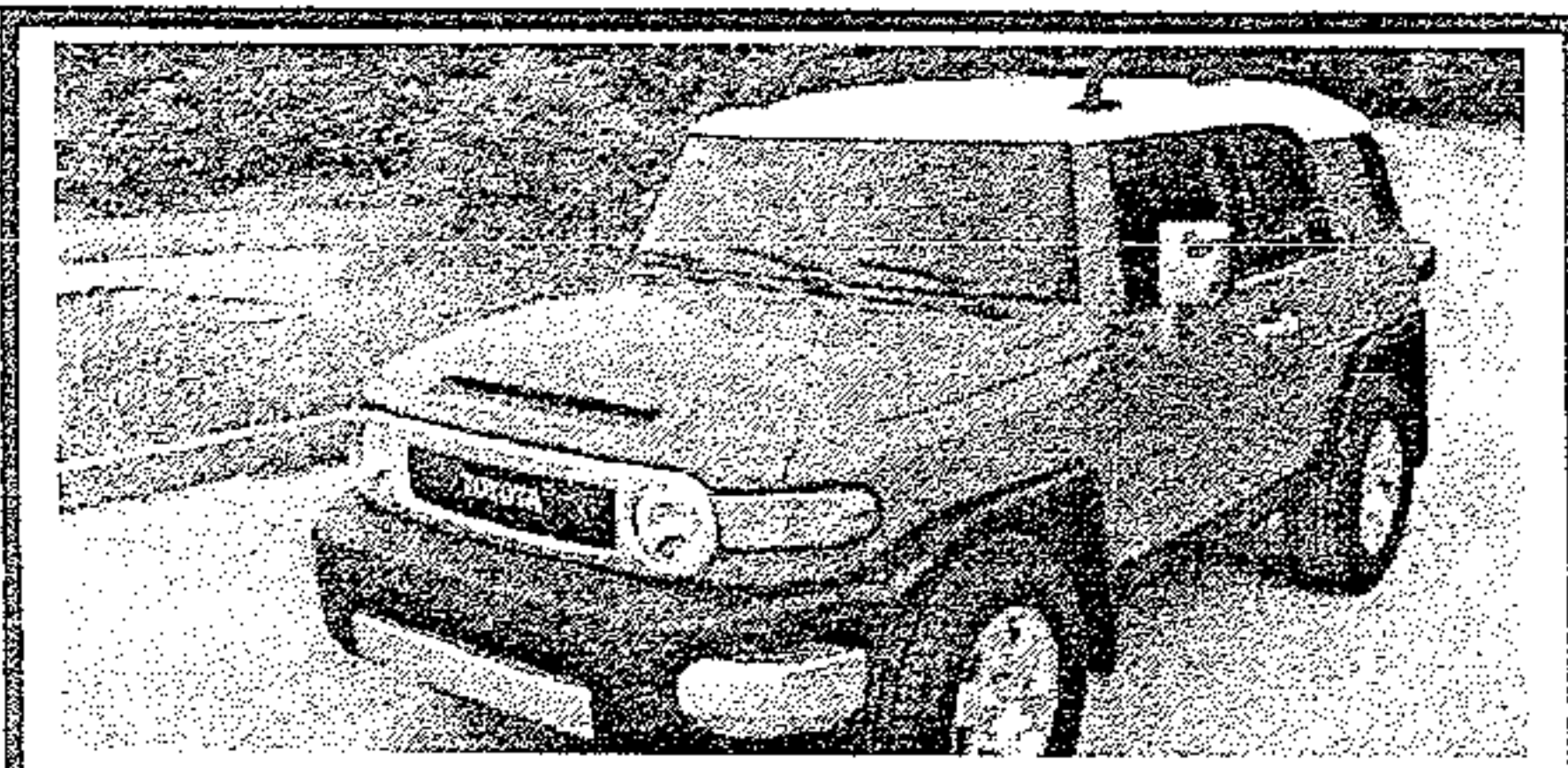

2007 Toyota FJ Cruiser Luggage Rack, Tow PKG, New Tires, V6, Auto, Immaculate



2013 Nissan Altima 3.6 V6, PS, PW, PL, 75k, Like New, Auto, Push Star



2012 Jeep Liberty Alloy Wheels, Luggage Rack, V6, Auto, A/C, Low Miles, Back-Up Camera

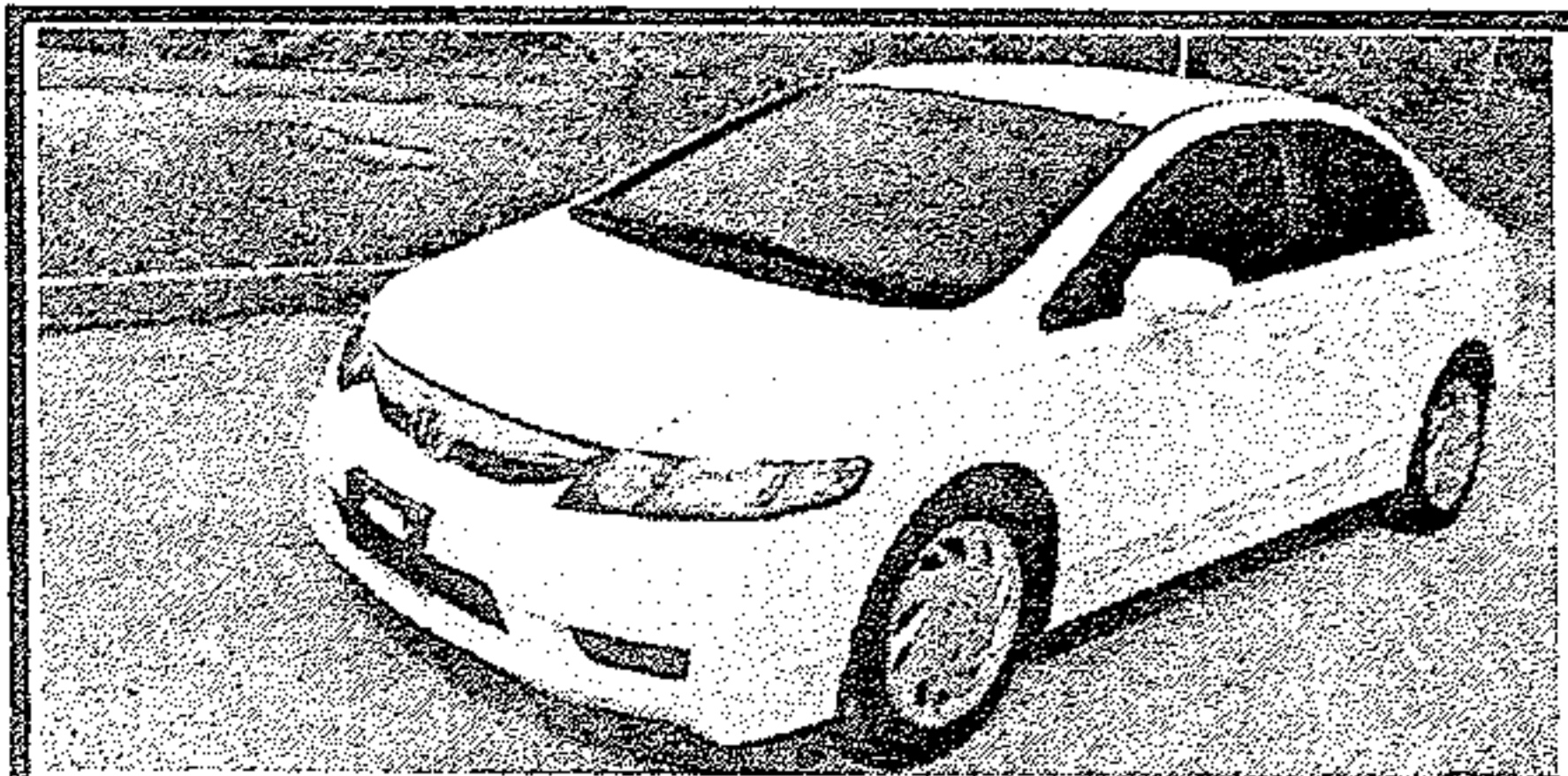

2011 Honda Civic Auto, Sporty, Gas Saver, AC, PW, PL, Tow PKG, Low Monthly Payments

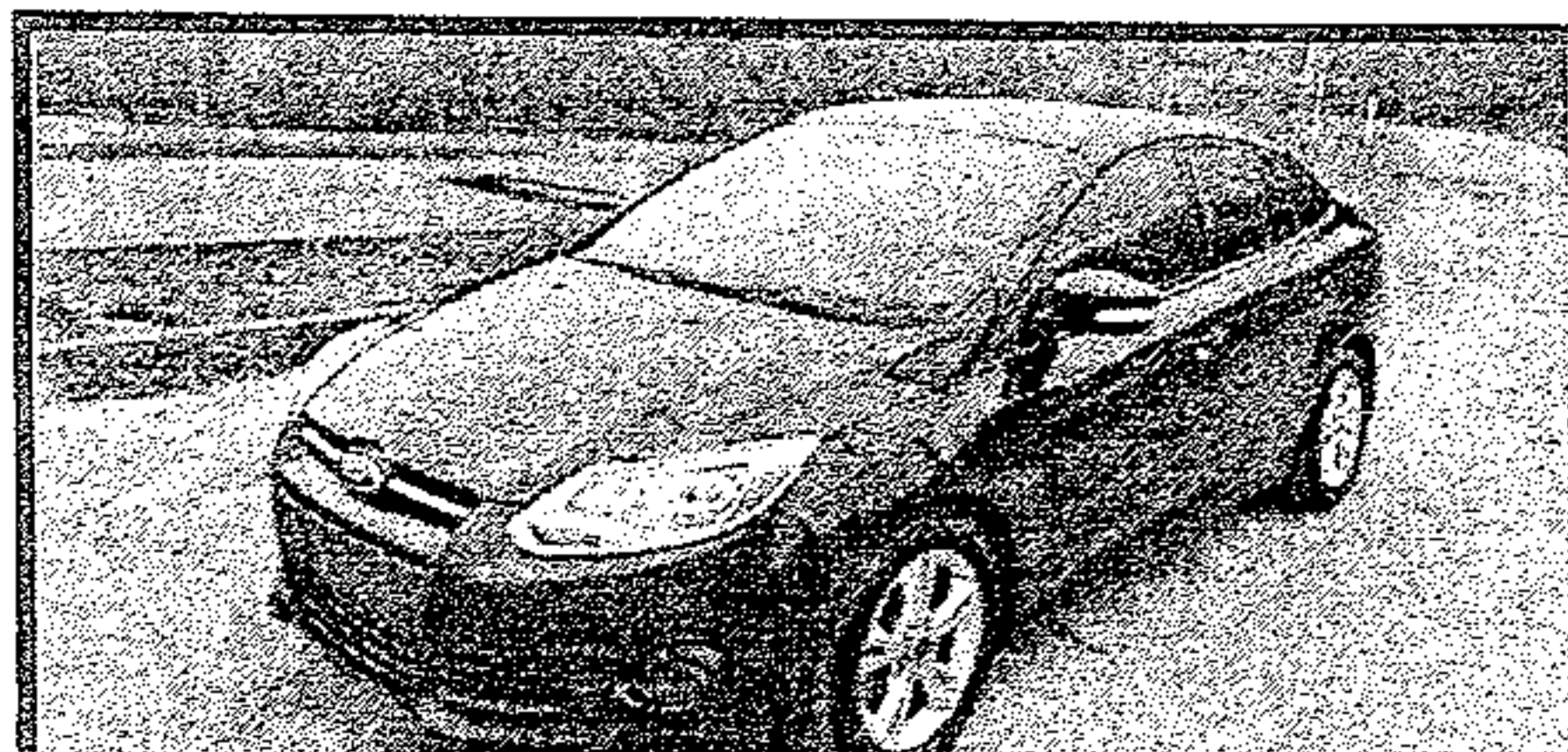

2014 Ford Focus 55k, Alloy Wheels, 5 Speed A/C, PW, PL, Sunroof, Factory Warranty



2014 Chevy Captiva 49k, PS, PW, PL, V6, Auto Alloy Wheels, Luggage

DEPENDABLE MOTORS 986-9343

803 E. Broadway • Lenoir City

Serving Loudon County for 20 Years

* WAC. See Dealer for details

Visit our website at: www.dependablemotorslc.com

team

John Wallace, 37, Old Lee Hwy Philadelphia, was charged with DUI, Simple Possession, Possession of Drug Para, Driving on Suspended/Revoked License, and Driving on Roadway laned for traffic.

Deputy Cody Fritts LCSO, observed a Green Dodge Journey traveling on Steekee Road. Deputy observed the

vehicle fail to maintain lane when both driver side tires crossed over the double yellow line into the on coming lane. Upon stopping the vehicle the driver as was identified as John Wallace. The passengers were identified. Mr. Wallace stated he was messing with his seat belt when he crossed the center line.

Mr. Wallace had yellow

powder in both nostrils of his nose. Upon running Mr. Wallace through dispatch he was found to be driving on a Revoked driver license. Deputy asked the owner of the vehicle if he could search the vehicle and she agreed. Found in the driver side door in a silver and gold canister was 1 yellow pill with imprint with C230 (Oxycodone 10 mg). Found on a key chain in the front seat was a silver canister. In

the silver canister was 2 yellow pills with imprint C230 (Oxycodone 10 mg). Mr. Wallace stated the pills were his. Mr. Wallace was taken into custody. Trooper Clendenen charged Mr. Wallace with DUI and transported him to the Fort Loudon Emergency Room for a Blood Draw. Mr. Wallace was then transported to the Loudon County jail. This did happen in Loudon County.



BIMBO'S

Deli Open 24 Hours
865-986-9643 Call Ins Welcome

Specials

Lg. Cold Sub, bag of chips and 16 oz. fountain drink only \$6.29

Footlong Corn Dog \$2.59

West End Storage & Warehouses

502 Ward Avenue • Loudon
Call 865-458-4774 or 865-679-5555



T
A
T
T
O
O

A Short Drive For A Lifetime Of Quality

Nationally Published Artist
Brian Jones

Serving East Tennessee since 1996

Always 100% Health Score

Like Us On Facebook at
Living art tattoo of tn

Open Late on Weekends
Tues-Sat 1pm-?
Sun & Mon by appt.

423-420-0380

Living Art Tattoo
Madisonville

P
I
E
R
C
I
N
G

C&J Towing and Recovery

LOWEST TOWING RATES AROUND!!!

Have you been overcharged for any type of towing service in the Lenoir City area? If you have a breakdown or accident please OWNER REQUEST C&J Towing with the officer. Also please call your Sheriff and ask him to place C&J Towing on the "Rotation List*" and help other motorists save as much as you did! We at C&J are locally owned and operated, State approved, licensed, bonded and insured. Call and let us know if your denied service or how we can be of assistance.

*note: the "Rotation List" is a list of wrecker services that provide service for wrecks, DUI's, breakdowns, etc. and are on an on-call basis for service. This list is approved by the Sheriff.

Cliff Teeters • Owner
865-809-1661



FBI

the personal information of more than 40 victims and using their identities to apply for more than \$1.5 million in loans.

The ticket company in California discovered something was amiss when the victims' banks and credit card companies sought their money back. The investigation led straight to Mercede, who had the tickets delivered to his home address or to his parents' house. It appeared to be a straightforward fraud case—until investigators started digging.

"A lot of the material that we got out of his apartment led me to believe there was something much, much greater going on here than a simple fraud," said Detective Sergeant Andy Capwill of the Chagrin Falls Police Department. What he found while sifting through thousands of pages of data was evidence of large money transfers, dozens of checking accounts, and what appeared to be a robust business trading

in the digital currency and payment network known as bitcoin. "I realized I was going to need some help here," said Capwill, who called the FBI.

In their joint investigation, Capwill and

special agents from the FBI's Cleveland Field Office discovered Mercede was buying large quantities of bitcoin from legitimate foreign exchanges and then reselling the bitcoin himself at a premium. The inherent appeal of his

business, Cryptocoin Capital Management, was its location in the U.S.—not in Russia or China, where people are leery to send their money—and that it did not require the same lengthy waiting period as the more reputable exchanges.

"A lot of the time, people who want bitcoin want it now, so they will go through more peer-to-peer transactions," said Special Agent Gary Sukowatey, one of the FBI investigators. "He was buying larger quantities and waiting whatever period was necessary to wait, then he would sell it to people that wanted bitcoin right away." The problem, he said, is these transactions are illegal

if you don't have a license.

Operating a money transmitting business requires registration through the U.S. Department of the Treasury, which has a bureau—the Financial Crimes Enforcement Network, or FinCEN—dedicated to collecting and analyzing information about financial transactions to combat money laundering, terrorist financing, and other financial crimes.

"A lot of the material that we got out of his apartment led me to believe there was something much, much greater going on here than a simple fraud."

Detective Sergeant

FBI ctd. pg. 5

Now Hiring
Landscape Install Team Member
 Landscapes & Gardens by Pam is a full-service landscape install, construction, and maintenance company. Looking for motivated, hard-working, and customer-service based people. We have immediate full-time openings in the company that will allow for growth and promotion. We are a high quality, customer-service based company with full-time work available, based on weather conditions.
 Experience in landscaping is a plus, but a willingness to learn and the ability to work in a team environment is of the utmost priority. Typical work week is 40-50 hours Monday - Friday, with time and half for any hours over 40.
 Requirements:
 Must have a valid's driver's license
 Must be able to pass a drug test
 Must have dependable transportation to and from work
Call 865-806-8992

Reward Offered
 "We are offering \$200 for the return of our baby's clothes and toys or any information that leads to their return. We had them stored in storage unit 51 at crossroad mini storage, which is located at Eatons crossroads across from waldrops. They are all we have left from when she was little. We won't ask any questions or be angry. Just please bring them back. For any information contact 865-566-7638 or amandaroberts771@gmail.com" Thank you.



Cumberland Ball Bonding Co

865-986-3733



HACIENDA Ayala's
Mexican Restaurant
 Market Dr. * Lenoir City (In Front of Food City)

Real Authentic Mexican Food at Affordable Prices
Outside of Mexico City!!!

BEST MARGARITA

You've Tried The Rest Now Come Have The Best!!!

We Accept ALL Competitors Coupons
986-3553

IT Director Wanted

Loudon County Government has an opening for the position of IT Director. The IT Director manages and administers IT department resources to effectively meet the needs of Loudon County Government. For a full list of duties, responsibilities, and required qualifications for this position, please visit the job posting on the Loudon County Government website (<https://loudoncounty-tn.gov>) under "General Information > Employment". Interested candidates who meet the qualifications should contact the Loudon County Mayor's Office no later than 4pm on May 24, 2017

Wreck

Harold Hawkins, 54, Elm Lane Loudon, was charged with DUI. Officer Sam Harrison LPD, was dispatched to Huffland Drive in reference to a mo-

tor vehicle accident. Upon arrival Officer observed a red vehicle in the front yard on Huffland Drive pushed up against a large bush and a neighboring car shed. There were skid marks

through the yard the rear wheels had been spinning at one point they had sunken in the ground. Officer observed a male passed out behind the wheel identified as Harold Hawkins. Officer de-

tected a strong odor of an alcoholic beverage coming from the vehicle. Hawkins had a very strong odor of alcoholic beverage about his person, blood shot eyes, very slurred speech, and was un-

steady on his feet, and appeared to have urinated himself. Officer had to stop sobriety test for fear Hawkins would fall. Hawkins submitted to breath test and blew 0.266.

FBI ctd. from pg. 4

Andy Capwill, Chagrin Falls (Ohio) Police Department

"You've got to do it the right way," said Special Agent Milan Kosanovich, who specializes in complex financial crimes and investigated the case with Sukowatey and Capwill. "It's perfectly fine to operate as a money exchanger for bitcoin. However, those exchangers, like other financial institutions in the U.S., have specific rules to follow to ensure compliance with anti-money laundering requirements."

In September 2014, Mercede boasted about his profits to a reporter for an online bitcoin publication. He claimed he averaged returns of 8 to 15 percent per day by buying off Chinese exchanges and then selling locally. "I can get some crazy returns right now," he was quoted saying.

Court records show Mercede wired funds to make daily purchases of \$10,000 and \$40,000 in bitcoin. Over six months beginning in August 2014, Mercede illegally converted or transmitted \$1.4 million. He was sentenced on March 21 to more than six years in prison. The case represents one of the first convictions for what is believed to be an increasingly frequent crime—operating an unlicensed money transmitting business.

see FBI conc. pg. 7

PURDY'S AUTO PARTS AND SALVAGE

WE BUY SCRAP IRON • COPPER • BRASS • ALUMINUM

\$

7

Complete Cars

per 100 lbs.

You Name It, We Buy It!

Radiators, Wheels, Batteries, Appliances, Farm Equipment

Copper

Paying Top \$\$\$

Call For Latest Prices

Scrap Metal

up to

5

per 100 lb

We Buy Batteries

Aluminum Cans

Paying Top \$\$\$

Call For Latest Prices

You Call We Haul!

423-519-5402

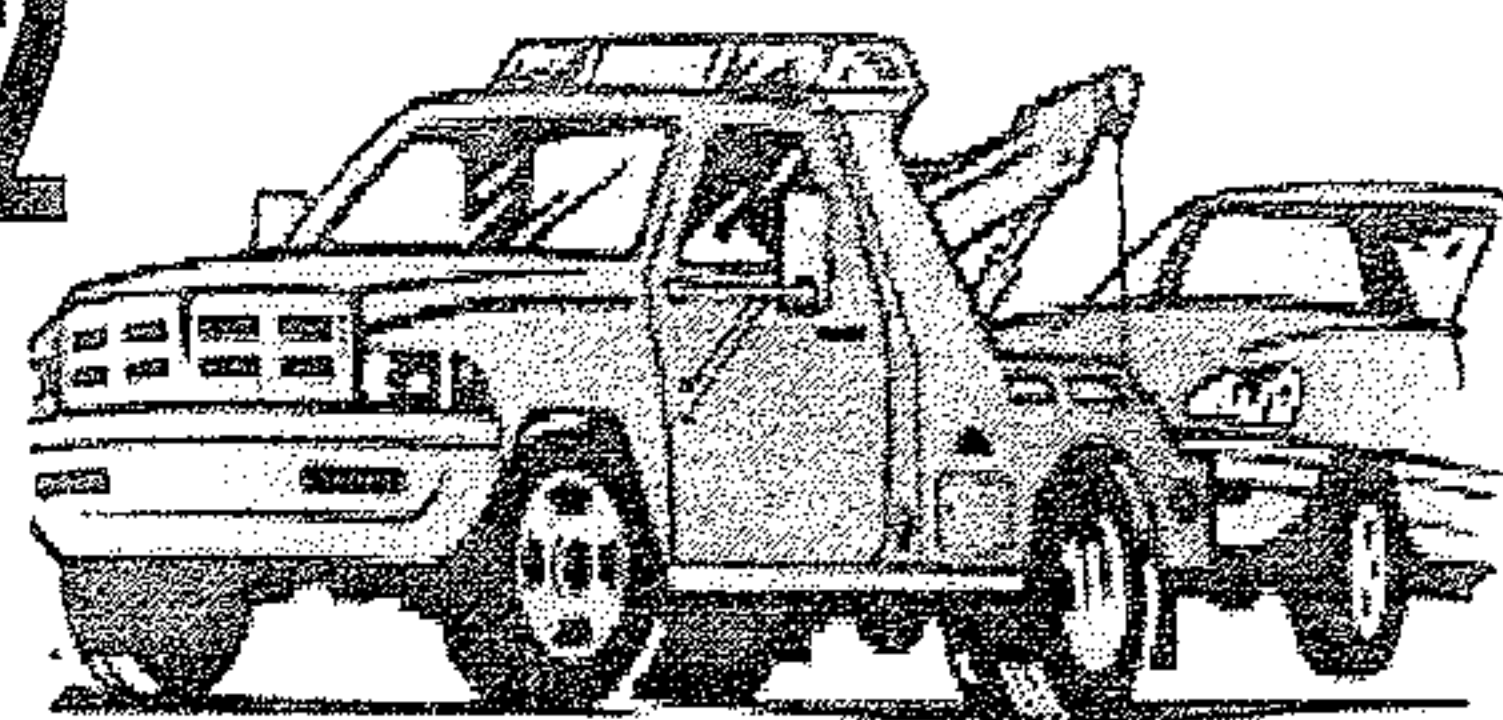

Prices subject to change with the market.

423 337-3977

149 County Road 323 Sweetwater

Now Selling Aftermarket Body Parts at Discount Prices

Prices subject to change with the market.

Charged

Milford Sexton, 45, Reese Street Rockwood, was charged with Driving without a Valid License. Deputy Kenneth Palmer LCSO, observed a silver vehicle traveling on Hwy 70. Deputy observed the vehicle run the red light while turning left onto Hwy 321. Deputy stopped the vehicle on Hwy 321 at Williams Ferry Road. Deputy made contact with the driver Milford Sexton. The tag was on a Chevrolet it came back to a Nissan. Deputy ran Sexton through dispatch that revealed Sexton was driving without a license. The tag was seize and Sexton was placed under arrest.

FBI conc. from pg. 5

The FBI agents stressed that trading in virtual currencies like bitcoin is perfectly legal—with the proper registration, licensing, and record-keeping requirements. “It’s easier for people not to do it and hope they don’t get charged with it,” said Sukowatey. “But as we were able to prove in this case, you can be charged criminally for not being registered.”

Capwill, who began the investigation, said he didn’t know what bitcoin was at the outset. But he appreciated the learning experience and working the joint investigation with the FBI—as well as the Internal Revenue Service and the U.S. Postal Inspection Service—to its conclusion. “It was

a lot of information being shared back and forth between the agencies, which was really helpful,” he said. “It’s always nice to know there’s somebody out there on the other end of the phone that can help you.”

Capias arrest
Tara Wallace, 42, Blinken Street Lenoir City, was charged with Criminal Court Capias.

Cpl. Brandon Dishner LCSO, was advised Deputy Mitchell Vinsant was out at the jail with a female. At that time Cpl Dishner made contact with Mrs. Tara Wallace. Mrs Wallace has an active Criminal Court Capias for Theft of Property \$1000.00-\$10,000.00 out of Criminal Court in Loudon County Tennessee. Cpl. Dishner then served warrant

number 2016-CR-257 on Mrs Wallace. This did occur at the Loudon County Jail, in Loudon County Tennessee.

Police beat
Hayley Webb, 23, Dotson Road Greenback, was charged with DUI, and Aggravated Assault.

Sgt. Jerramie Bowen, Deputy Lane and Deputy Dailey did re-

spond to Dotson Rd. to attempt to serve a warrant on Haley Webb. Deputy did make contact with Mrs. Webb and take her into custody for Warrant number 2017-cr-580 1 and 2. DUI and Aggravated Assault. Deputy then transported her to the Loudon County Jail. This did occur in Loudon County.

PUBLIC NOTICE

The Lenoir City Utilities Board has scheduled a Workshop on Monday, May 15, 2017, at 3:30 p.m. to discuss funding for the construction of LCUB’s Main Lift Station. The meeting will be held at City Hall, 530 Hwy 321 N, Lenoir City, Tennessee 37771.

STAINED INK

TATTOO & PIERCING

LENOIR CITY 865 816-6440

NEW OWNER • NEW ARTIST • SINCE 2011

521 Hwy 321 next to Vape & Stuff & Inn Of Lenoir!

Clean-Affordable-Quality-Custom

Tattoo's You've Always Wanted!

BRING IN THIS AD FOR **\$25 OFF**
NEW INK FOR NEW CUSTOMERS ONLY!

Check us out on FB.com/
Stained.Inc.Tattoo/
www.STAINEDINC.com

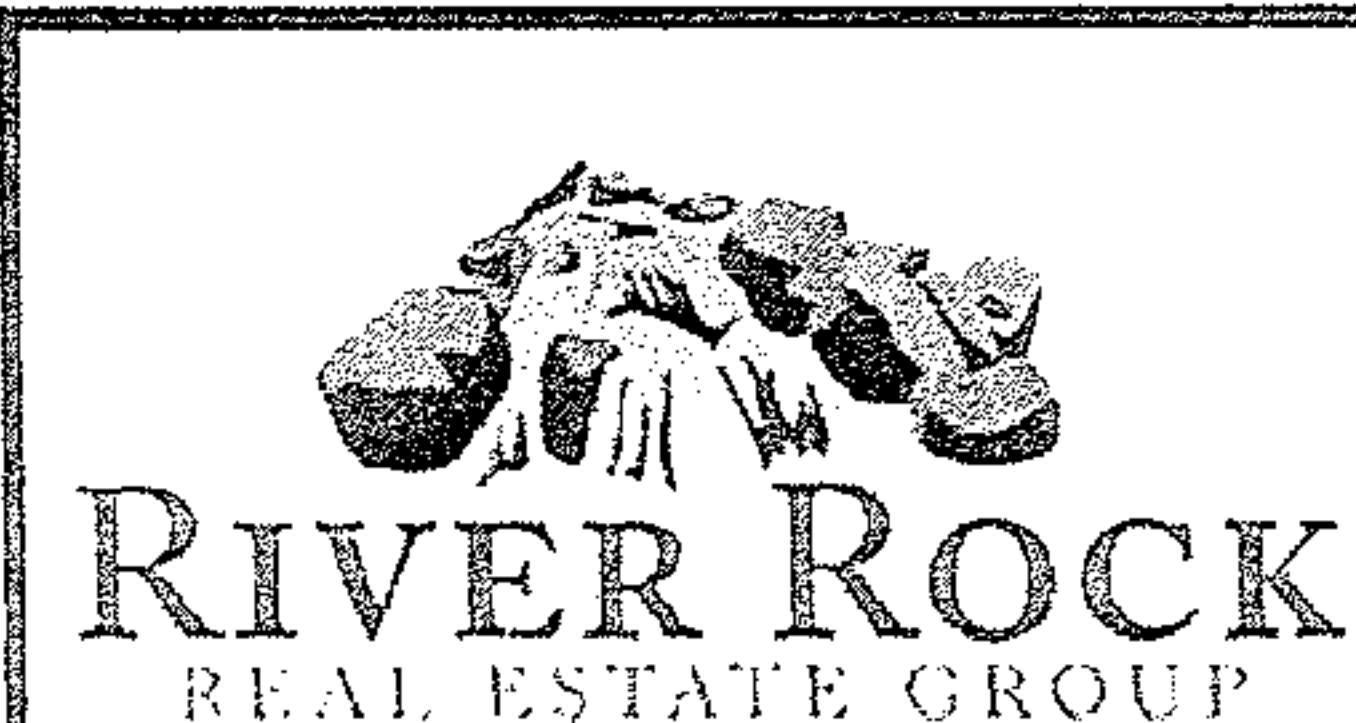

Pennie Lindsey
Affiliate Broker

River Rock Real Estate Group

www.RiverRockTN.com

Pennie@riverrocktn.com

865-755-5264 - Cell

865-635-9706 Ext. 2 - Business

A Name You Already Know And Trust Just Got Even More Dependable

DEPENDABLE AUTO SERVICE, LUBE AND TIRES

is Now Offering

Expert, Affordable Transmission Service

All ASE Certified Technicians

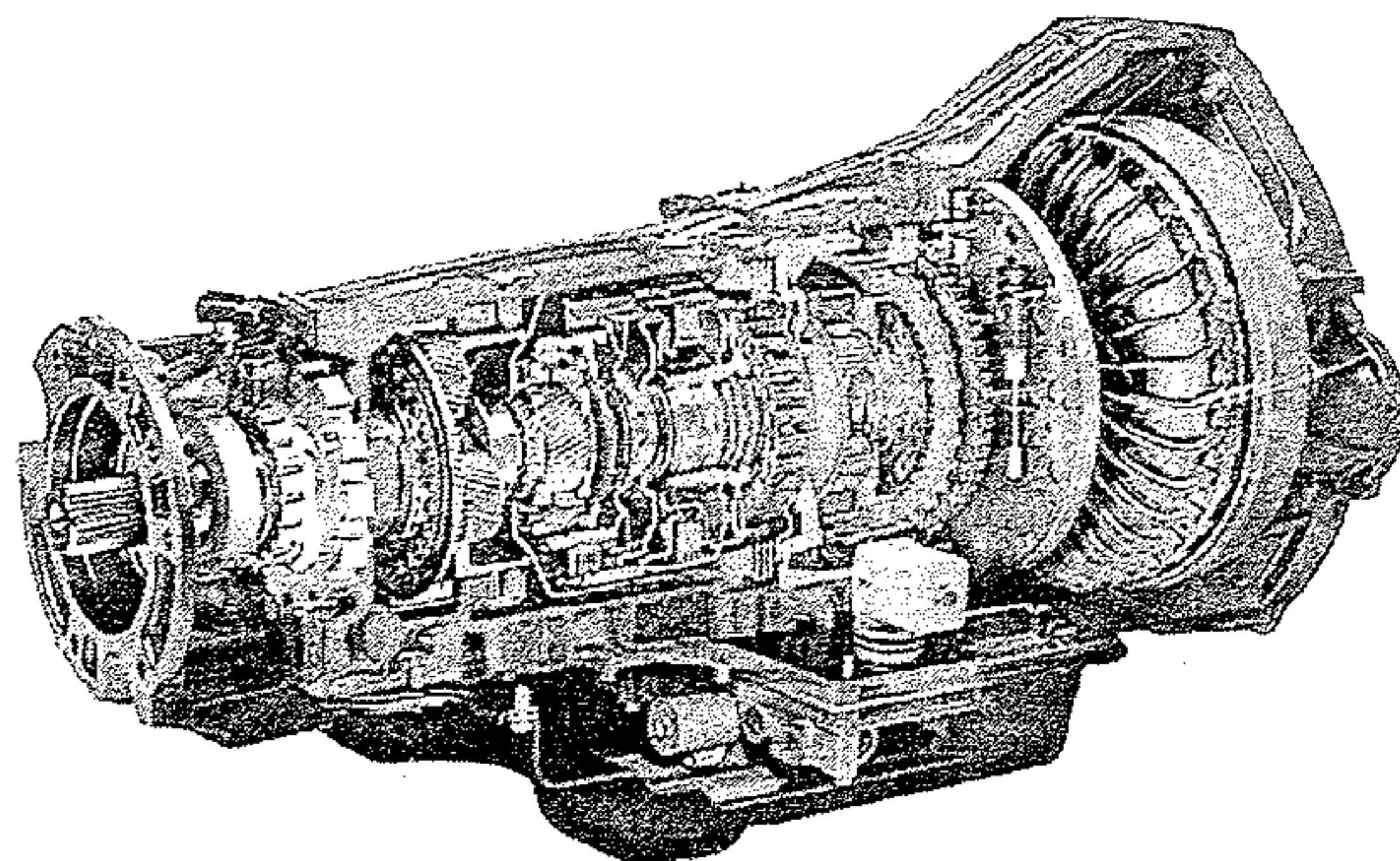

We proudly welcome all New Customers and Former Advanced Transmission Customers with a 10% Discount and Any Transmission Service or Repair*

865-986-9359

865-986-5050