

# Daily Edition

Serving Loudon, Monroe and Surrounding Counties

Friday, May 11, 2017

## Two wanted subjects charged after LCSO traffic stop

Jessica Hood, 33, Gardner Road Philadelphia, was charged with DUI, Poss. of Drug Para., and Assisting other Agency.

William Sloan, 40, Hawkins Road Sweetwater, was charged with Poss. of Drug Para., and Assisting other Agency.

Deputy Cody Fritts LCSO, was dispatched to Grandview Drive on a disturbance. Dispatch advised that Com- (see wanted pg. 2)



Jessica Hood

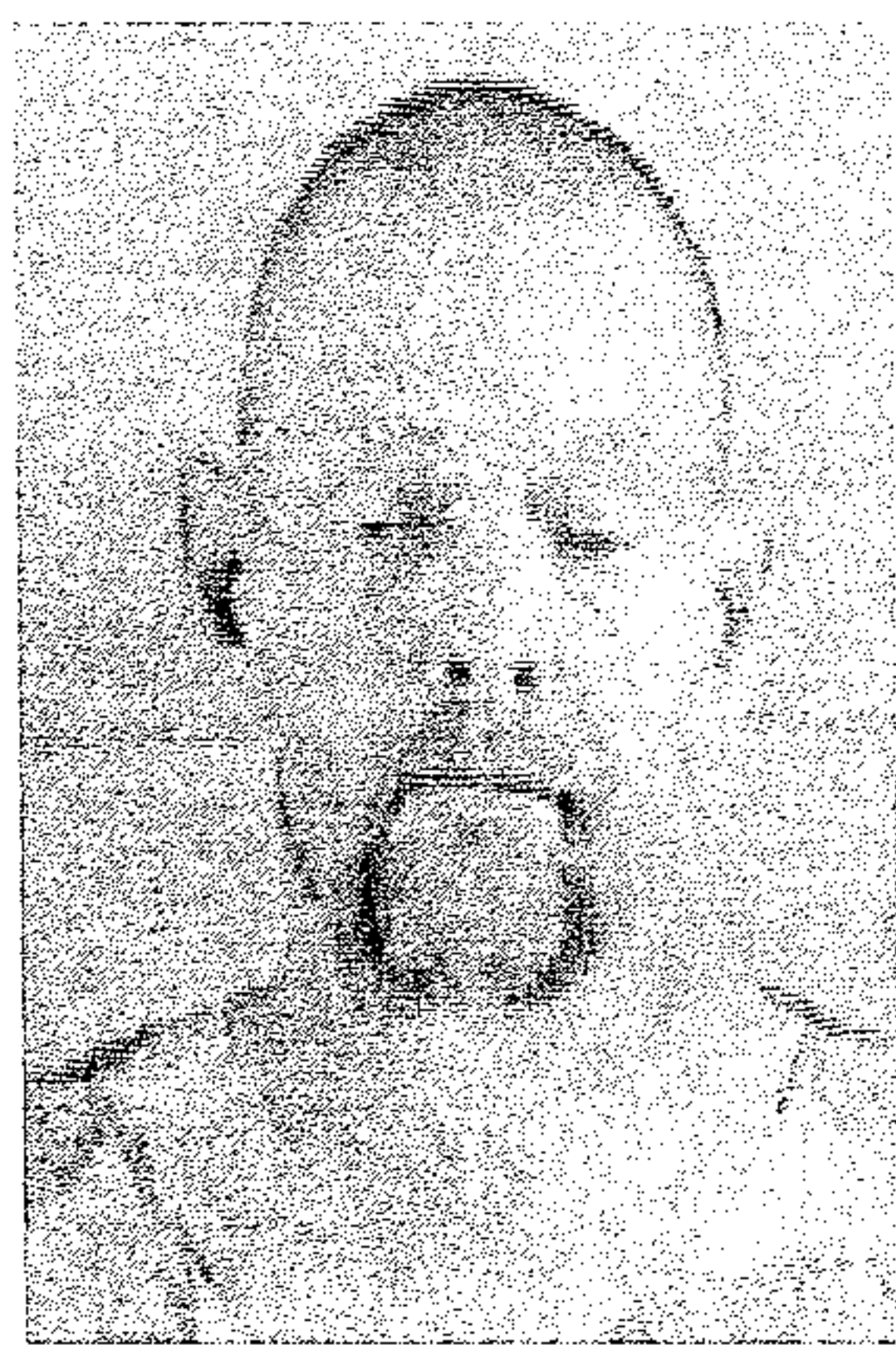

William Sloan

## Loudon woman charged following traffic stop



Denise Davis

see charged pg. 3

## Charges filed after rocking horse thrown



Chad Jones

see DV pg. 5

## Kim Trent to discuss The Past and Future City at Library's Books Sandwiched In program

In recognition of National Historic Preservation Month, Knox County Public Library invites the public to join Kim Trent for a discussion of Past and Future City: How Historic Preservation is Reviving America's Communities by Stephanie Meek and Kevin C. Murphy, at noon on Wednesday, May 24, in the East Tennessee History Center auditorium. Books Sandwiched In is sponsored by the

see library pg. 7

## Sovereign Citizens Sentenced 'Stole' Vacant Homes and Filed False Claims to Intimidate Officials

A group of so-called sovereign citizens laid claim to this home in Media, Pennsylvania and fraudulently offered it for sale for \$2,000 down and \$500 a month. The group illegally claimed 70 properties worth \$9 million.

For more than three years, a Pennsylvania group claiming to be sovereign citizens—and therefore not

subject to U.S. law—schemed to “steal” dozens of foreclosed homes worth millions of dollars and sell them to unsuspecting victims.

The scheme came to light after local officials in Delaware County, Pennsylvania, received documents declaring sovereign citizen status for three residents. Alarmed, the officials contacted

(see FBI pg. 4)

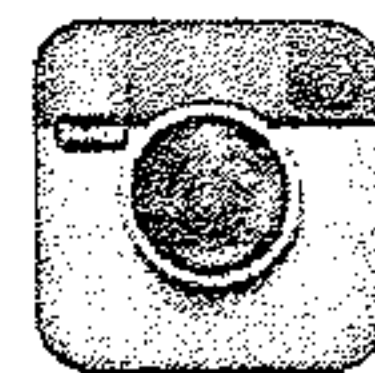

Follow us on Instagram



LIKE US ON

facebook

### Verse of the Day

He who heeds discipline shows the way to life, but whoever ignores correction leads others astray. — Proverbs 10:17

### Obituaries

see inside **Wazzup**

Be sure to do something extra special for your Mom this Mother's Day Weekend! You only have one so

show them how much you appreciate them! Love You Mom!

### Weather

Today: Scattered thunderstorms in the morning, then mainly cloudy during the afternoon with thunderstorms likely.

High near 75F.

Tonight: Showers likely and possibly a thunderstorm during the evening, then some lingering showers still possible overnight. Low 57F.

Saturday Showers in the (Continued on page 6)



3 08805 93489 2



## Help Wanted Drivers Needed

Malones Wrecker Service

must have "F" Endorsement on driver license

Call 986-0051

## NEED HELP WITH INCOME TAX? PROFESSIONAL TAX SERVICE

**PRICE - 95% of returns between \$60-\$140**

(No Coupons Required)

**LOCALLY Owned & Operated - Open Year Round**

**30+ Years in the business**

**ALL Preparers with 10+ years experience**

**Pro Tax**

**111 E. Broadway  
Lenoir City, TN 37771**

**Phone 865-986-4035**

\*US Armed Service Active Duty Personnel, "THANK YOU", Tax Return Free

## Wanted

plaintain was beating on his Ex girlfriends door trying to get her to open it. Upon arrival Deputy made contact with Jessica Hood, William Sloan, and Complainant. Jessica Hood was sitting in the driver seat and William Sloan was in the passenger

seat of a White Ford Expedition. Upon running Ms. Hood through dispatch she was found to have a revoked driver license and had warrants out of Monroe County and McMinn County. Upon running Mr. Sloan through dispatch

(see wanted ctd. pg. 3)

Notice: The Daily Edition does not knowingly accept fraudulent or misleading materials. The Daily Edition cannot guarantee the validity of offerings or statements contained herein. All liability for the contents of all advertising, and for any claims that may arise therefrom, is the responsibility of the advertiser or its agency. The Daily Edition reserves the right to reject, edit, or abbreviate any advertisement submitted. Advertising is accepted with the understanding that all liability for all copyright violations is the sole responsibility of the advertiser.

Photographs, artwork and other copy submitted for publication is considered the sole property of the advertiser. The Daily Edition will make every effort but will not be liable for failure to publish and ad or for typographical and layout errors. All statements and information about highlights featured items, letters to the editor, herein are those solely given to the interviewer or writer and the Daily Edition assumes no responsibility of the accuracy or validity thereof. The Daily Edition will gladly reprint at no charge that part of an advertisement in which an error occurs provided a claim is made within 3 days of the first publication of the ad. Information contained in the Wazzup is received anonymously and the Daily Edition assumes no responsibility for information and reserves the right to edit or reject any and/or all submissions. The Daily Edition is a daily newspaper of general circulation in Loudon County defined under TCA 2-1-104(a)(13).

The Daily Edition also serves Monroe, Knox, Anderson, Roane and Blount counties and serves 30,000 readers weekly. Send mail to PO Box 1240, Lenoir City TN 37771. 865-771-2249. email: dan1204us@yahoo.com

The Daily Edition is Loudon County's premier public interest and paid advertising paper. The Daily Edition is produced and published daily Monday through Friday and is circulated throughout Loudon County and parts of Monroe and Knox Counties. Display advertising rates \$5.00 per column inch and quantity discounts available. Call for information on upcoming promotions and events.

## Good Credit OK • Bad Credit OK • Bankruptcies OK • Repo OK \*



2004 BMW Z4 Convertible, 77k, Garage Kept, Alloy Wheels, Heated Seats, PS, PW,



2013 Nissan Altima 3.6 V6, PS, PW, PL, 75k, Like New, Auto, Push Star



2012 Jeep Liberty Alloy Wheels, Luggage Rack, V6, Auto, A/C, Low Miles, Back-Up Camera



2008 Ford F150 93k, EXT Cab, V8, Auto, Tow PKG, Bed Liner, Like New, PW, PL, A/C

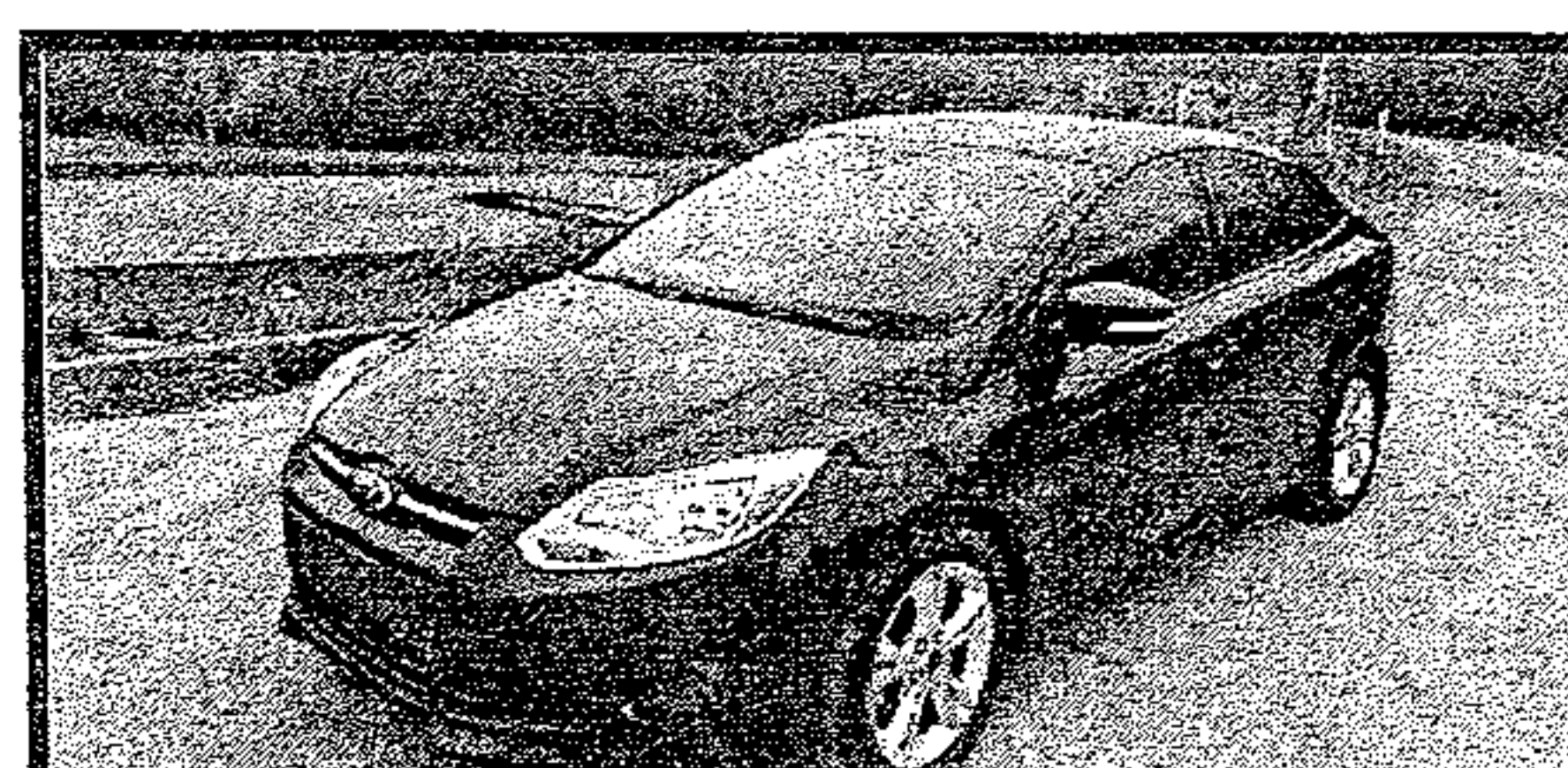

2014 Ford Focus 55k, Alloy Wheels, 5 Speed A/C, PW, PL, Sunroof, Factory Warranty



2012 BMW 335i Twin Power Turbo V6, NAV, Sport Pkg, Sunroof, Heated & Cooled Seats

# DEPENDABLE MOTORS 986-9343

803 E. Broadway • Lenoir City

Serving Loudon County for 20 Years

\* WAC. See Dealer for details

Visit our website at: [www.dependablemotorslc.com](http://www.dependablemotorslc.com)



### Charged

Denise Davis, 38, Main Street Loudon, was charged with DUI, Simple Possession, Tampering/Fabricating with Evidence, and Driving on Roadways laned for Traffic.

Deputy Cody Fritts LCSO, observed a green vehicle traveling on Hwy 11 near Pond Creek Road. Deputy observed the vehicle cross the turning lanes as the vehicle continued straight.

The vehicle then crossed over the double yellow lines. Upon stopping the vehicle the driver was identified as Denise Davis. Davis had bloodshot and pinpoint eyes. Deputy ask if he could search the vehicle and she agreed. While Davis was standing behind the patrol vehicle Deputy noticed Davis put one hand behind her back and appeared to throw something. After checking the area Dep-

uty retrieved 3 orange wafers (methadone). Davis originally stated she did not throw the pills and then later stated she threw the pills because she was scared. Davis was placed under arrest.

wanted ctd. from pg. 2

he was found to have a warrant out of Knox County. Deputy asked Ms. Hood if she had anything illegal in the vehicle and she stated she had a syringe in her backpack. Deputy asked Mr.

Sloan if he had anything illegal in the vehicle and he stated he had a syringe in his coat pocket. Deputy asked complainant if he could search his vehicle and he agreed. Ms. Hood's backpack was located in the back seat. Found in the back pack in a black case was 1 spoon and 2 syringes. Also located in the backpack was a Marijuana pipe and 2 cut straws. Located in Mr. Sloan's jacket pocket was a orange sunglass case that contained 2 syringes. Jessica

wanted conc. pg. 5



# BIMBO'S

**Deli Open 24 Hours**  
**865-986-9643 Call Ins Welcome**

## Specials

**Lg. Cold Sub, bag of chips and 16 oz. fountain drink only \$6.29**

**Footlong Corn Dog \$2.59**

## West End Storage & Warehouses

**502 Ward Avenue • Loudon**  
**Call 865-458-4774 or 865-679-5555**



T  
A  
T  
T  
O  
O

## A Short Drive For A Lifetime Of Quality

**Nationally Published Artist**  
**Brian Jones**

**Serving East Tennessee since 1996**

**Always 100% Health Score**

**Like Us On Facebook at**  
**Living art tattoo of tn**

**Open Late on Weekends**  
**Tues-Sat 1pm-9**  
**Sun & Mon by appt.**

# 423-420-0380

## Living Art Tattoo

**Madisonville**

P  
I  
E  
R  
C  
I  
N  
G

## C&J Towing and Recovery

### LOWEST TOWING RATES AROUND!!!

Have you been overcharged for any type of towing service in the Lenoir City area? If you have a breakdown or accident please OWNER REQUEST C&J Towing with the officer. Also please call your Sheriff and ask him to place C&J Towing on the "Rotation List\*" and help other motorists save as much as you did! We at C&J are locally owned and operated, State approved, licensed, bonded and insured. Call and let us know if your denied service or how we can be of assistance.

\*note: the "Rotation List" is a list of wrecker services that provide service for wrecks, DUI's, breakdowns, etc. and are on an on-call basis for service. This list is approved by the Sheriff.

**Cliff Teeters • Owner**  
**865-809-1661**





**FBI**

the FBI shortly after receiving the documents in May 2010.

Officials had good reason to be concerned: That same month, two so-called sovereign citizens opened fire on police during a traffic stop in Arkansas, killing two officers. The ambush is just one example of how members of the movement often turn to violence.

Sovereign citizens are anti-government extremists who claim the federal government is operating outside its jurisdiction and they are therefore not bound by government authority—including the courts, taxing entities, motor vehicle departments, and even law enforcement.

They also are prone to engage in numerous types of financial frauds and schemes, based on their skewed interpretation of law.

“Most of these sovereign citizens are extremists,” said Special Agent Walter Szpak, who investigated the case out of the FBI’s Philadelphia Field Of-

office. “When they get arrested, they don’t believe they have committed a crime, and they believe they have the right to retaliate.”

Knowing the potential for criminal and even violent activity

by sovereign citizens, FBI agents decided to interview the three people in Pennsylvania who signed the declarations of sovereignty: Steven Hameed, Darnell Young, and Damond Palmer. Hameed and Young were

married.

“It’s not illegal to file this kind of paperwork,” explained Szpak. “This is America; they can say whatever they want. But it’s essentially a warning to law enforcement, saying, ‘We’re about to start committing criminal acts.’”

Which is exactly what Hameed, Young, and Palmer were doing. The trio scoured public records to find foreclosed houses in Delaware County, west of Philadelphia. Then they crafted jargon-laden paperwork claiming ownership on 70 properties worth more than \$9 million. Most of the homes belonged to the U.S. Department of Housing and Urban Develop-

ment (HUD) or Wells Fargo bank.

After staking fraudulent claims to the properties, they listed the houses as rent-to-own opportunities on Craigslist at low prices, Szpak said.

FBI agents could not find the three suspects at first to conduct an initial interview about their claims of sovereign status; they did not live at the addresses listed on their declarations. Agents kept looking, using property records to track them down.

“Every time we went to one of these addresses, someone else was living there,” Szpak said. “The tenants told us they had bought or rented the

FBI ctd. pg. 5

**Now Hiring**

**Landscape Install Team Member**

Landscapes & Gardens by Pam is a full-service landscape install, construction, and maintenance company. Looking for motivated, hard-working, and customer-service based people. We have immediate, full-time openings in the company that will allow for growth and promotion. We are a high quality, customer-service based company with full-time work available, based on weather conditions.

Experience in landscaping is a plus, but a willingness to learn and the ability to work in a team environment is of the utmost priority. Typical work week is 40-50 hours Monday - Friday, with time and half for any hours over 40.

**Requirements:**

Must have a valid’s driver’s license

Must be able to pass a drug test

Must have dependable transportation to and from work

Call 865-806-8992

**Reward Offered**

“We are offering \$200 for the return of our baby’s clothes and toys or any information that leads to their return. We had them stored in storage unit 51 at crossroad mini storage, which is located at Eatons crossroads across from waldrops. They are all we have left from when she was little. We won’t ask any questions or be angry. Just please bring them back. For any information contact 865-566-7638 or amandaroberts771@gmail.com” Thank you.



**Cumberland Ball Bending Co**

**865-986-3733**

**HACIENDA Ayala's**

**Mexican Restaurant**

Market Dr. \* Lenoir City (In Front of Food City)

Real Authentic Mexican Food at Affordable Prices **Outside of Mexico City!!!**

You've Tried The Rest Now Come Have The Best!!!

**BEST MARGARITA**

We Accept ALL Competitors Coupons 986-3553

**IT Director Wanted**

Loudon County Government has an opening for the position of IT Director. The IT Director manages and administers IT department resources to effectively meet the needs of Loudon County Government. For a full list of duties, responsibilities, and required qualifications for this position, please visit the job posting on the Loudon County Government website (<https://loudoncounty-tn.gov>) under “General Information > Employment”. Interested candidates who meet the qualifications should contact the Loudon County Mayor’s Office no later than ??:?? on May ??, 2017.



DV

Chad Jones, 27, W 7th Ave Lenoir City, was charged with Domestic Assault. Officer Espinoza LCPD, was dispatched to 7th Ave on a disturbance

call. Upon arrival Officer made contact with the victim, who stated that her boyfriend Chad Jones started an argument. Jones was upset that victim lost her ins. Victim state Jones calls her wel-

fare mom. During the argument Jones threw a rocking horse at victim, striking her in the right arm, in the triceps area. There was a substantial mark of this assault. Victim stated that Jones

threw victim phone in the neighboring woods to avoid her making contact with anyone that can help her. Jones also threw victims clothes in the woods. Jones was placed under arrest.

Trio conc. from pg. 3

Hood and William Sloan were taken into custody. Mr. Sloan was transported to the Loudon County jail. Trooper Clendenen charged Ms. Hood with DUI and transported her to the Fort Loudon Emergency room for a blood draw and then to the Loudon County jail. This did happen in Loudon County.

FBI ctd. from pg. 4

property from the people we were looking for. That's when we realized what they were doing."

As the scope of the fraud became more apparent, the FBI was joined in the investigation by other agencies, including HUD, the Federal Deposit Insurance Corporation, the Federal Housing Finance Agency, and several county and local police departments.

In the midst of the federal investigation into the fraud, Hameed, Young, and Palmer were charged by local police for offenses such as trespassing. In response, the three played another trick popular within the sovereign movement: "paper terrorism." They filed more than 250 fraudulent IRS forms against numerous state and local law enforcement officials and judges. The fake 1099-DIV and 1099-INT forms falsely claimed that the victims had been paid hundreds of thousands or even millions of dollars in dividends or interest.

Because the forms were fake, the victims did not know they had been filed and obviously did not pay any taxes on the income. see FBI conc. pg. 7

# PURDY'S AUTO PARTS AND SALVAGE

WE BUY SCRAP IRON • COPPER • BRASS • ALUMINUM



# 7

## Complete Cars

per 100 lbs.

Scrap Metal

up to

# 5

per 100 lb

You Name It, We Buy It!  
Radiators, Wheels, Batteries, Appliances, Farm Equipment

**Copper**  
Paying Top \$\$\$  
Call For Latest Prices

**We Buy Batteries**

**Aluminum Cans**  
Paying Top \$\$\$  
Call For Latest Prices

**You Call We Haul!**  
**423-519-5402**

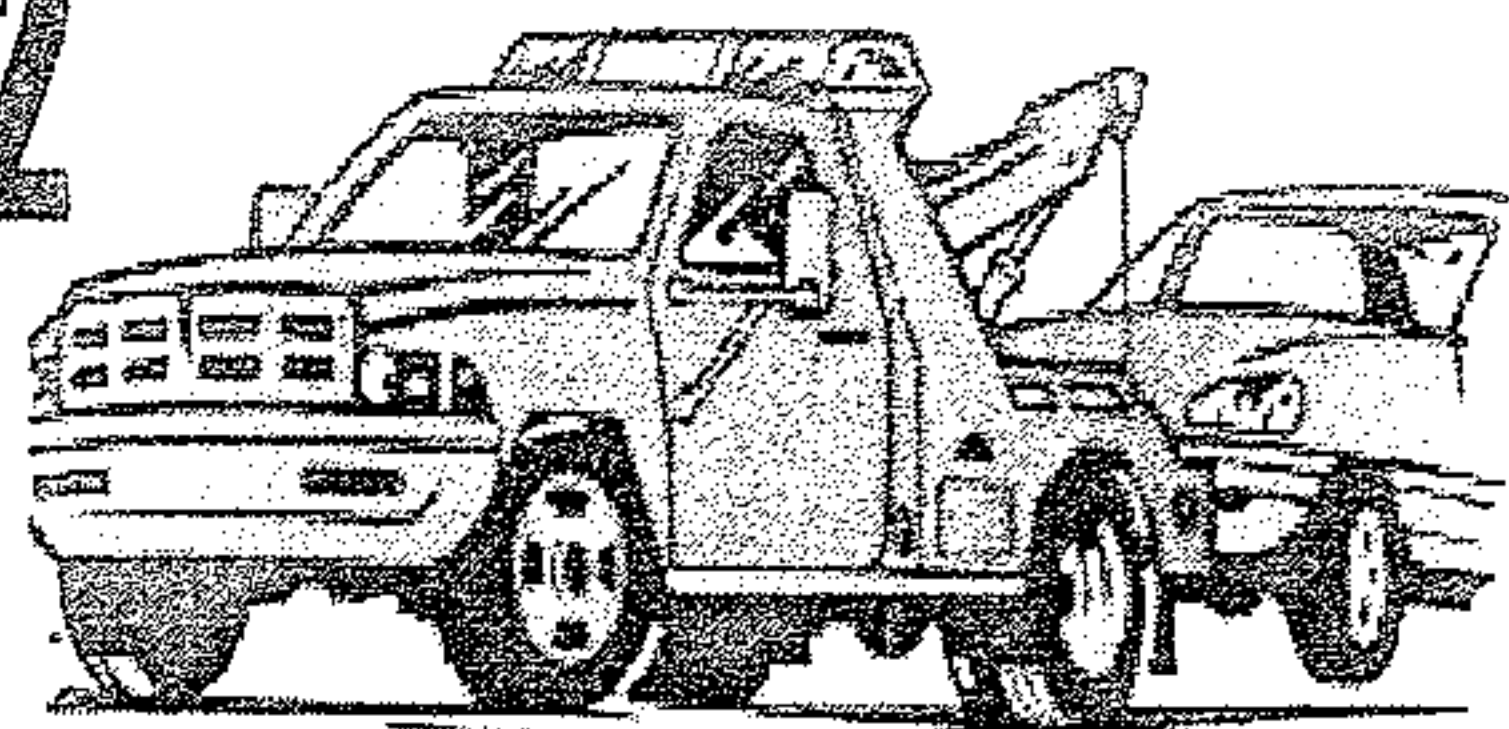

**Now Selling**  
**Aftermarket**  
**Body Parts at**  
**Discount Prices**

Prices subject to change with the market.

**423 337-3977**  
**149 County Road 323 Sweetwater**

Prices subject to change with the market.



**Library**

Friends of the Knox County Public Library. Attendees may bring lunch. Drinks are available to purchase.

As Executive Director of Knox Heritage, a non-profit, historic preservation organization that serves the 16-county East Tennessee region, Trent is tuned into the benefits of historic preservation. "Knoxville is now reaping the rewards from the investments in preservation we have made over the last 25 years and is nationally recognized for the preservation-based renaissance we're experiencing in our historic downtown and neighborhoods," Trent said. "The Past and Future City affirms many of the lessons

we've learned here and provides a road map to navigate the challenges still ahead."

Kim Trent has worked in preservation professionally and as a community volunteer and advocate at the local, state and national level for 23 years and is a proponent of preservation-based community and economic development. She is a native of Mobile, Alabama, a graduate of the University of Alabama and has two children, Spencer and Katherine.

"Stephanie Meeks makes a compelling case for creating great cities through historic preservation and she shares strategies that can guide us along the way," Trent said. "She also addresses the challenges we all face in preservation since the

work touches on so many aspects of our communities - history, economics, urban planning, diversity, transportation, affordable housing, sustainability, architecture, real estate, and government among many others. But for those who value history, architecture and sustainable communities, the rewards are definitely worth the struggle and make success all the sweeter and more meaningful."

Book Sandwiched In will continue on June 28, when Dr. Todd Freeberg, UT Department of Psychology, leads a discussion of Beyond Words: How Animals Think and Feel by Carl Safina.

FBI conc. from pg. 5

In some cases, the IRS placed liens against the victims or seized tax refunds they would

have otherwise been owed.

"These fraudulent tax forms can have a real impact on victims," Szpak said. "And, even though they are fake, some of them can remain on victims' credit reports for years."

They also added to a growing list of federal charges the trio faced. The three were charged in December

2015 with conspiracy to commit offenses against the United States, bank fraud, and corrupt interference with Internal Revenue laws, among other crimes. All three pleaded guilty in June 2016. Hameed was sentenced to eight years in prison in February; Young and Palmer received shorter sentences in 2016.

**PUBLIC NOTICE**

The Lenoir City Utilities Board has scheduled a Workshop on Monday, May 15, 2017, at 3:30 p.m. to discuss funding for the construction of LCUB's Main Lift Station. The meeting will be held at City Hall, 530 Hwy 321 N, Lenoir City, Tennessee 37771.

**STAINED INC.**  
**TATTOO & PIERCING**  
 LENOIR CITY 865 816-6440  
 NEW OWNER • NEW ARTIST • SINCE 2011  
 521 Hwy 321 next to Vape & Stuff & Inn Of Lenoir!  
 Clean-Affordable-Quality-Custom  
 Tattoo's You've Always Wanted!

BRING IN THIS AD FOR **\$25 OFF**  
 NEW INK FOR NEW CUSTOMERS ONLY!

Check us out on FB.com/  
 Stained.Inc.Tattoo/  
 www.STAINEDINC.com

**RIVER ROCK**  
 REAL ESTATE GROUP



*Pennie Lindsey*  
 Affiliate Broker

River Rock Real Estate Group  
 www.RiverRockTN.com  
 Pennie@riverrocktn.com  
 865-755-5264 - Cell  
 865-635-9706 Ext. 2 - Business

A Name You Already Know And Trust Just Got Even More Dependable  
**DEPENDABLE AUTO SERVICE, LUBE AND TIRES**  
**is Now Offering**  
**Expert, Affordable Transmission Service**  
 All ASE Certified Technicians

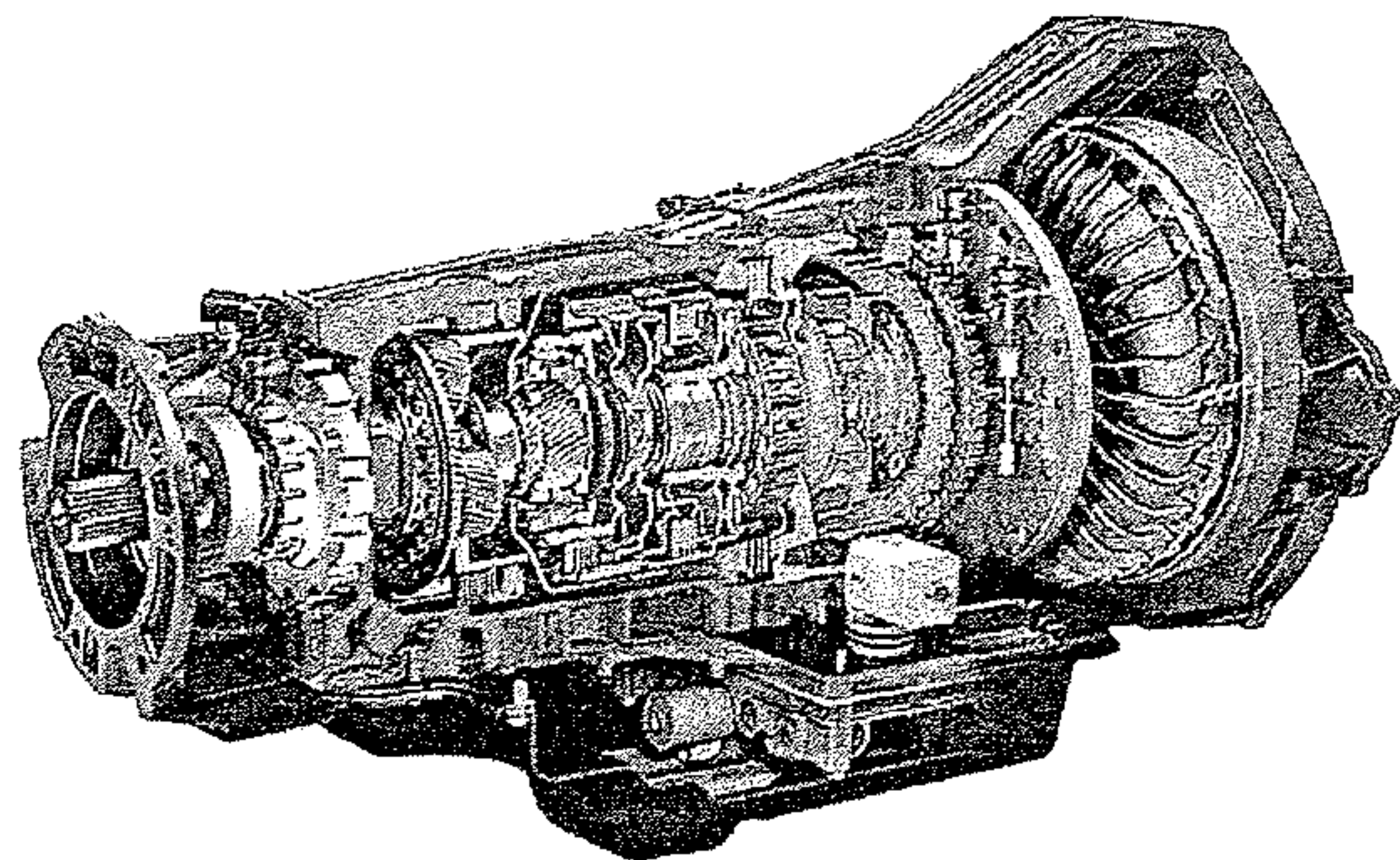

**We proudly welcome all New Customers and Former Advanced Transmission Customers with a 10% Discount and Any Transmission Service or Repair\***

**865-986-9359**

**865-986-5050**