

# Daily Edition

Serving Loudon, Monroe and Surrounding Counties

Friday, April 21, 2017

## Loudon County Grand Jury Report Inside

Inside today's Daily Edition contains the Loudon County Grand Jury Report in its entirety. The Grand Jury meets in Loudon County only three times a year. The Grand Jury is presented evidence of cases that law enforcement has gathered against an individual.

That evidence after being presented is re-

viewed by the Grand Jury who either determines there is enough evidence to issue a warrant for a trial in the future.

If the Grand Jury determines there is enough evidence for a trial they return a True Bill. A continued on bound over means the case is continued to a future Grand Jury. A dismissal means there

was not enough evidence to warrant a trial by Grand Jury.

The report is an exact copy of the one received from the Circuit Court. Any errors, omissions, or mistakes are not the responsibility of The Daily Edition. Any questions about the report should be directed to the Circuit Court Clerk's Office in Loudon.

## DUI and more for unwanted guest

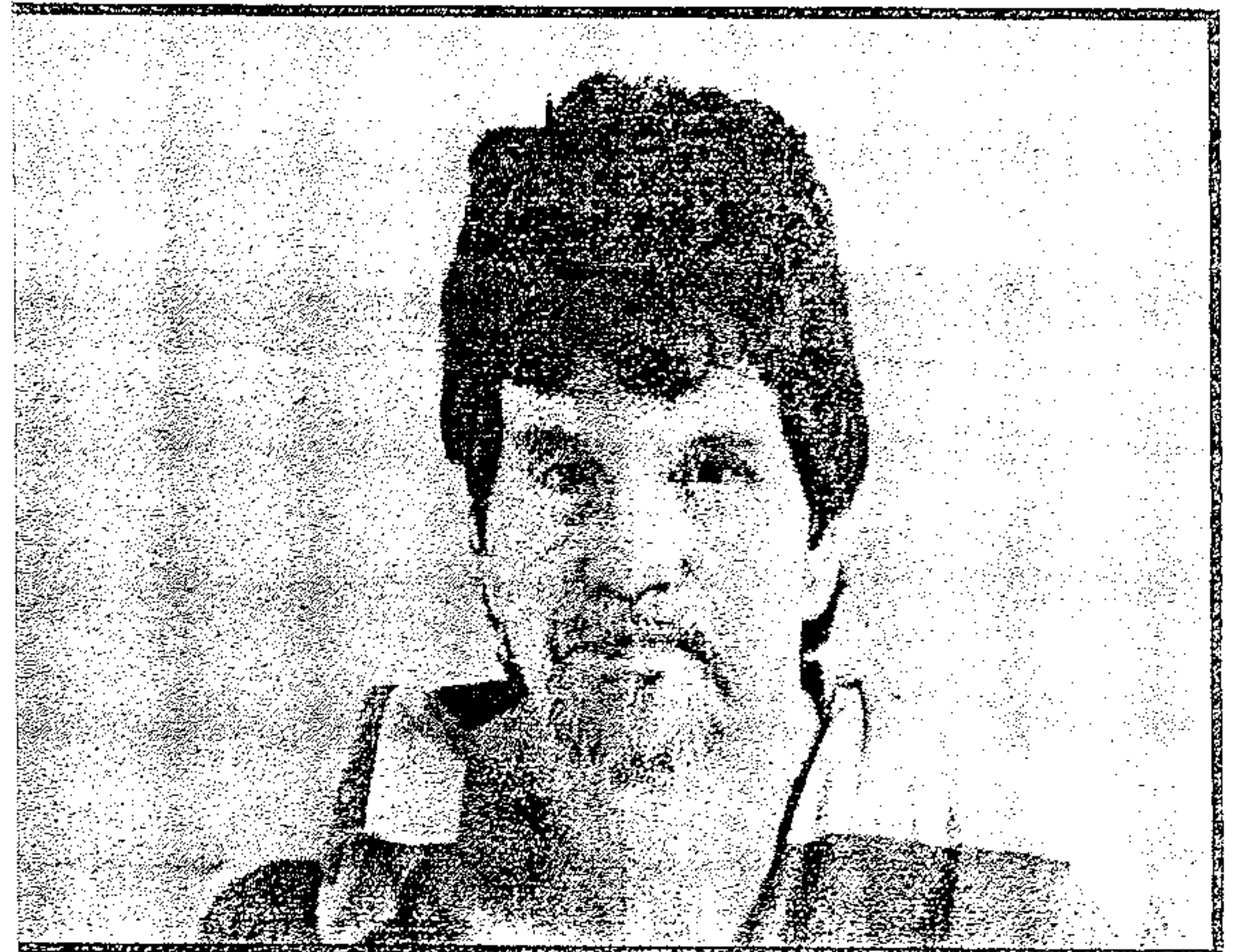

Jefferey Graves

see unwanted pg. 3

## New Market VFD Chief Stole from Department

An investigation by the Tennessee State Comptroller has resulted in the indictment of New Market Volunteer Fire Department Chief Frank Solomon.

Investigators determined that Solomon stole at least \$1,105 from the fire department by charging personal purchases to fire department accounts at multiple auto parts stores.

Solomon bought auto parts and accessories for his personal vehicles, for a family member's personal vehicle, and for vehicles owned by private individuals which Solomon had contracted to repair. All of these charges were paid with fire department funds.

Additionally, investigators found that Solomon misused the fire department's sales tax

see theft pg. 5

## Victim slammed against wall



Christopher Murrell

see domestic pg. 7

## Investigation Reveals Problems within Town of Oakland

An investigation by the Tennessee Comptroller's Office has raised several questions about payments, policies and use of property within the Town of Oakland in Fayette County.

Investigators found the former town recorder received a compensatory time payment totaling

\$45,006.01 at the end of her employment with the town. This payment was made in violation of town policy. Furthermore, the validity of the 1,532.01 hours of accrued compensatory could not be verified.

Additionally, Comptroller investigators determined the mayor (see Oakland pg. 4)

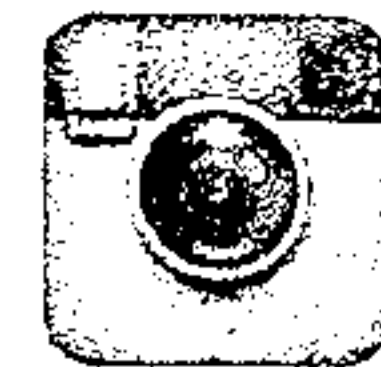

Follow us on Instagram



### Verse of the Day

Then the end will come, when he hands over the kingdom to God the Father after he has destroyed all dominion, authority and power. — 1 Corinthians 15:24

### Obituaries

see inside **Wazzup**

The Grand Jury report is inside today. Enjoy the weekend everyone!

### Weather

Today: Except for a few

afternoon clouds, mainly sunny. A stray shower or thunderstorm is possible. High 84F.

Tonight: Some clouds and possibly an isolated thunderstorm after midnight. Low 62F.

Friday Scattered thun-

derstorms in the morning, then mainly cloudy during the afternoon with thunderstorms likely. High 82F.

Friday Night Thunderstorms in the evening then variable clouds over-

(Continued on page 6)



### Unwanted

Jeffrey Graves, 52, Jackson Bend Road Lenoir City, Driving on Revoked /Suspended License, and DUI. Deputy Kenneth Palmer LCSO, observed a white vehicle traveling north on Jackson Bend Road. Deputy observed the

vehicle turn onto a place there was not supposed to be anyone there except the owner. When Deputy arrived at the driveway he observed the driver Jeffery Graves had already exited the vehicle. Deputy ask what he was doing on the property.

unwanted ctd. pg. 5

**Office Visit  
as low as \$65**



**First Med Farragut**  
Family Medical Clinic  
Low Cost Office Visits  
**865-392-1840**  
(Not A Pain Clinic)



# BIMBO'S

**Deli Open 24 Hours**

**865-986-9643 Call Ins Welcome**

**Specials**

**Lg. Cold Sub, bag of chips and 16 oz. fountain drink  
only \$6.29**

**Footlong Corn Dog \$2.59**

**West End Storage & Warehouses**  
502 Ward Avenue • Loudon  
Call 865-458-4774 or 865-679-5555

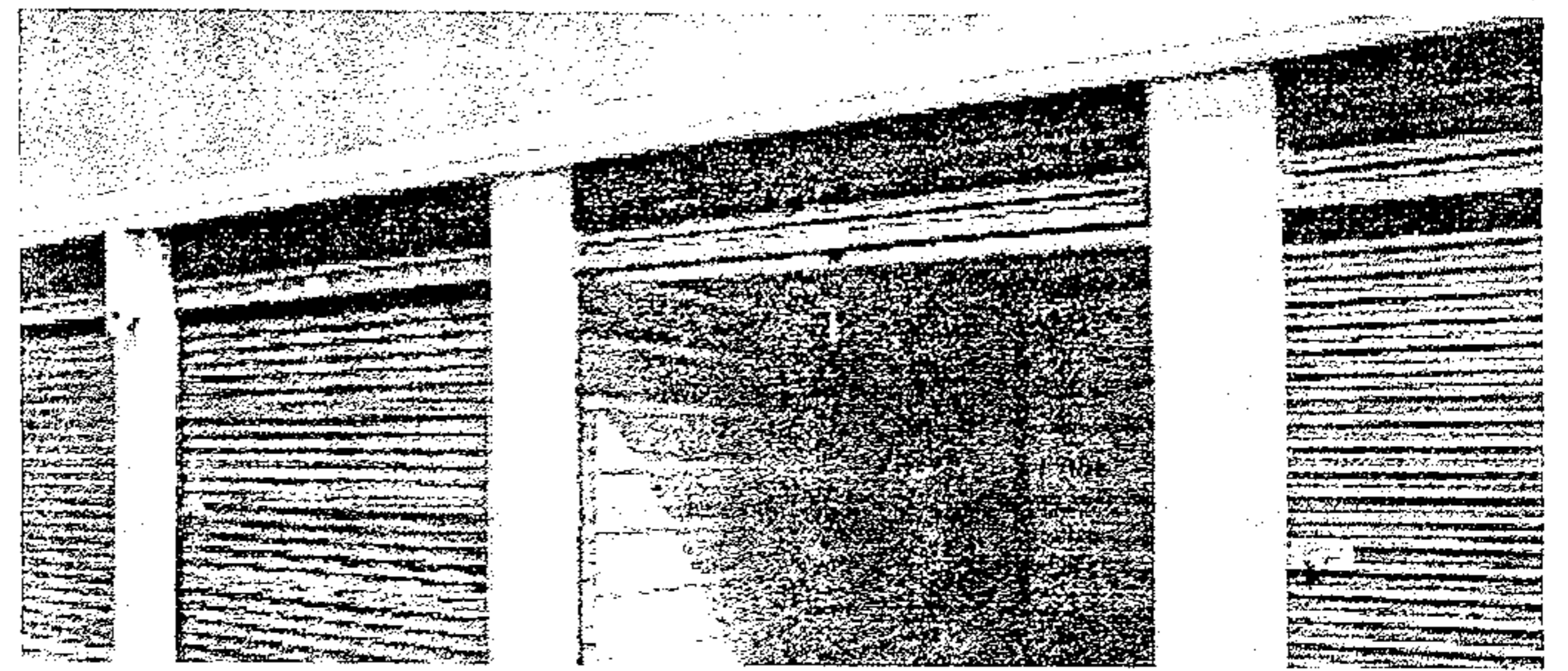

**A Short Drive For A  
Lifetime Of Quality**

**Nationally Published Artist  
Brian Jones**

**Serving East Tennessee since 1996**

**Always 100% Health Score**

**Like Us On Facebook at  
Living art tattoo of tn**

**Open Late on Weekends  
Tues-Sat 1pm-9  
Sun & Mon by appt.**

**423-420-0380**

**Living Art Tattoo  
Madisonville**

## C&J Towing and Recovery

**LOWEST TOWING RATES AROUND!!!**

Have you been overcharged for any type of towing service in the Lenoir City area? If you have a breakdown or accident please OWNER REQUEST C&J Towing with the officer. Also please call your Sheriff and ask him to place C&J Towing on the "Rotation List\*" and help other motorists save as much as you did! We at C&J are locally owned and operated, State approved, licensed, bonded and insured. Call and let us know if your denied service or how we can be of assistance.

\*note: the "Rotation List" is a list of wrecker services that provide service for wrecks, DUI's, breakdowns, etc. and are on an on-call basis for service. This list is approved by the Sheriff.

**Cliff Teeters • Owner**  
**865-809-1661**

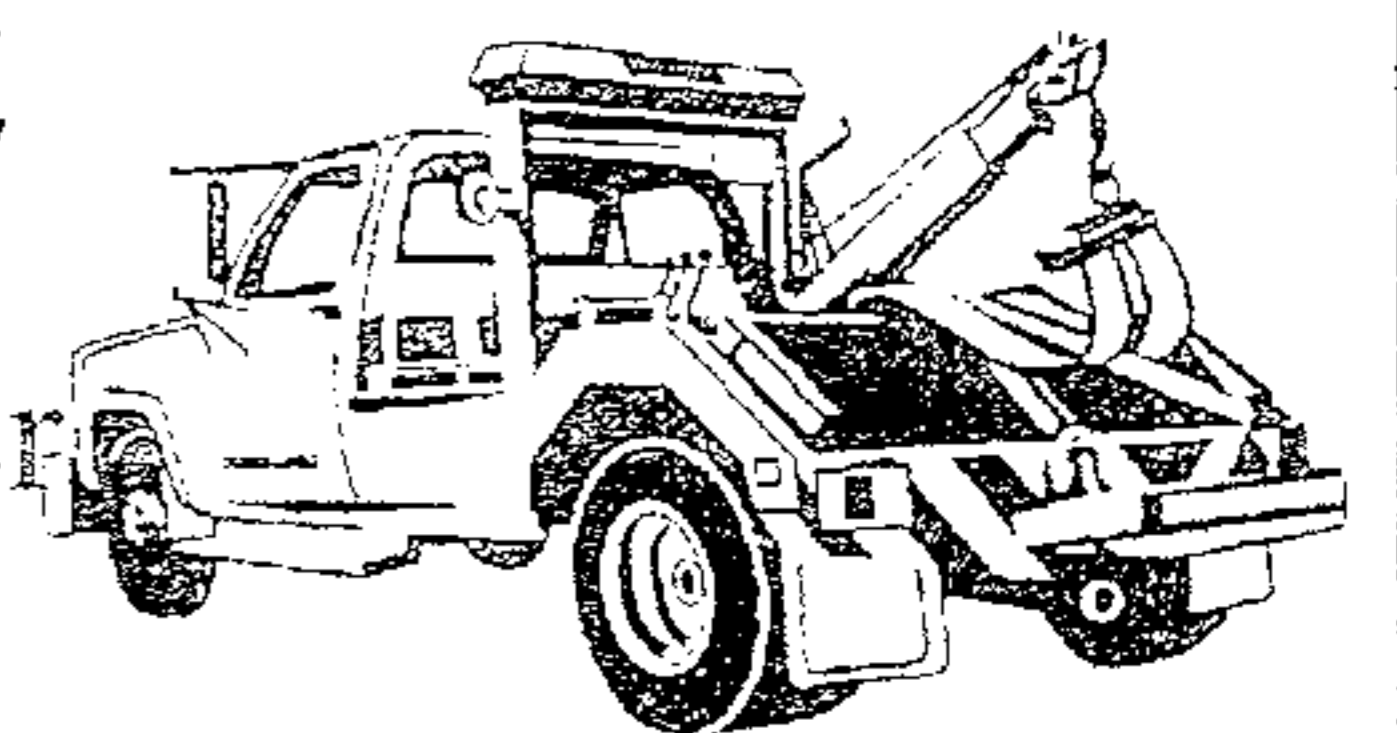

**Oakland**

of Oakland is using town owned property to conduct his full-time private sector job. The mayor has held this job throughout his term of office and works both his private sector job and performs his duties as mayor out of his city hall office. Investigators noted the mayor is frequently out of town and unavailable to town employees during the day.

The investigation also found the town of Oakland entered into business with a private company to upgrade the town's information systems. The company charged the town \$52,172.29 over a ten month period. It appears the company was directed to invoice the town in a manner that would help circumvent the town's purchasing policies. Purchases exceeding \$10,000 are required to be compet-

itively bid. Investigators found no evidence that the work was bid as required.

The findings and recommendations in the investigative report have been reviewed

with the district attorney general for the Twenty-fifth Judicial District.

"In addition to the issues noted above, our investigators also found numerous ac-

counting and administrative problems within the town's operations," said Comptroller Justin P. Wilson. "I encourage the Board of Mayor and Aldermen to address each of these issues to improve accountability."

To view the investigative report online, go to: <http://www.comptroller.tn.gov/ia/>

If you suspect fraud, waste or abuse of pub-

lic money in Tennessee, call the Comptroller's toll-free hotline at (800) 232-5454, or file a report online at: [www.comptroller.tn.gov/hotline](http://www.comptroller.tn.gov/hotline). Follow us on twitter: @TN-COT

**To Advertise Call**

**865-771-2249**

**20% OFF**

Bring this ad to Jiffy Park Produce, Grove Street, Loudon and receive a 20% Discount on all your favorite fruit and veggies!

**20% OFF**



**Now Hiring**  
**Landscape Install Team Member**  
 Landscapes & Gardens by Pam is a full-service landscape install, construction, and maintenance company. Looking for motivated, hard-working, and customer-service based people. We have immediate full-time openings in the company that will allow for growth and promotion. We are a high quality, customer-service based company with full-time work available, based on weather conditions.  
 Experience in landscaping is a plus, but a willingness to learn and the ability to work in a team environment is of the utmost priority. Typical work week is 40-50 hours Monday - Friday, with time and half for any hours over 40.  
 Requirements:  
 Must have a valid's driver's license  
 Must be able to pass a drug test  
 Must have dependable transportation to and from work  
**Call 865-806-8992**

**B&C portable sawmilling**  
 'I will come to you or you can come to me'  
 Call  
**865-816-0054**

**Reward Offered**  
 "We are offering \$200 for the return of our baby's clothes and toys or any information that leads to their return. We had them stored in storage unit 51 at crossroad mini storage, which is located at Eatons crossroads across from waldrops. They are all we have left from when she was little. We won't ask any questions or be angry. Just please bring them back. For any information contact 865-566-7638 or amandaroberts771@gmail.com" Thank you.

**Cumberland Ball Bonding Co**  
**865-986-3733**

**HACIENDA Ayala's**  
**Mexican Restaurant**  
 Market Dr. \* Lenoir City (In Front of Food City)  
 Real Authentic Mexican Food at Affordable Prices **Outside of Mexico City!!!**  
**BEST MARGARITA**  
 You've Tried The Rest Now Come Have The Best!!!  
 We Accept ALL Competitors Coupons  
**986-3553**

**The Collision Center Inc.**, is locally owned and operated by **Stan Ledbetter** and **Jake Tillett**. Along with their staff, they have over 136 years of combined experience in the collision repair business.  
 After working for *Knoxville Collision Center* for years before it was sold to an out of state corporation, Stan and Jake have fulfilled their dreams of owning and running their own shop.  
 "We are a family of past co-workers who have been together for 15 years. **We support ALL our military and are ALL VOL!** Stop by and see us and you will know with us **"Quality is not an option it is the only standard we will accept."**  
 The Collision Center, Inc.  
 10439 Lexington Drive  
 Knoxville, TN  
**865-288-7919**

**Collision Center Inc.**  
**865-288-7919**

theft

exemption and vehicle title registration discount when he registered a Dodge Charger that he purchased with his personal funds in the fire department's

name. The vehicle was to be used "exclusively for fire protection purposes."

Chief Solomon, who is also an elected constable in Jefferson County, placed decals and other markings

identifying the Dodge Charger as a constable car and used the vehicle for both constable and fire department duties.

Chief Solomon admitted to investigators that he charged

personal purchases to the fire department accounts. He also acknowledged that he used the Dodge Charger for constable duties as well as for fire department purposes.

In April 2017, Frank

Solomon was indicted by the Jefferson County Grand Jury on one count of theft over \$1,000, one count of sales tax fraud over \$500, one count of theft under \$500, and two counts of official misconduct.

"It's important that volunteer fire departments require and retain detailed invoices and receipts for purchases," said Comptroller Justin P. Wilson. "These documents should be carefully reviewed to ensure that inappropriate charges are promptly detected."

To view the investigative report online, go to: <http://www.comptroller.tn.gov/ia/>.

If you suspect fraud, waste or abuse of public money in Tennessee, call the Comptroller's toll-free hotline at (800) 232-5454, or file a report online at: [www.comptroller.tn.gov/hotline](http://www.comptroller.tn.gov/hotline). Follow us on twitter: @TN-COT

unwanted ctd from pg. 3

Graves stated he was going to get a stove. Deputy called dispatch and had them call the owner. Dispatch ask the owner if Graves was suppose to be there he stated yes but he was not allowed to take anything from the property. The owner was advised that Graves stated he was there to get a stove, the owner got very upset and wanted Deputy to make them leave.

see unwanted conc. pg. 7

# PURDY'S AUTO PARTS AND SALVAGE

WE BUY SCRAP IRON • COPPER • BRASS • ALUMINUM

\$

**7**

**Complete Cars**  
per 100 lbs.

You Name It, We Buy It!

Radiators, Wheels, Batteries, Appliances, Farm Equipment

**Copper**

Paying Top \$\$\$

Call For Latest Prices

**Scrap Metal**

up to

**5**

per 100 lb

**We Buy Batteries**

**Aluminum Cans**

Paying Top \$\$\$

Call For Latest Prices

**You Call We Haul!**

**423-519-5402**

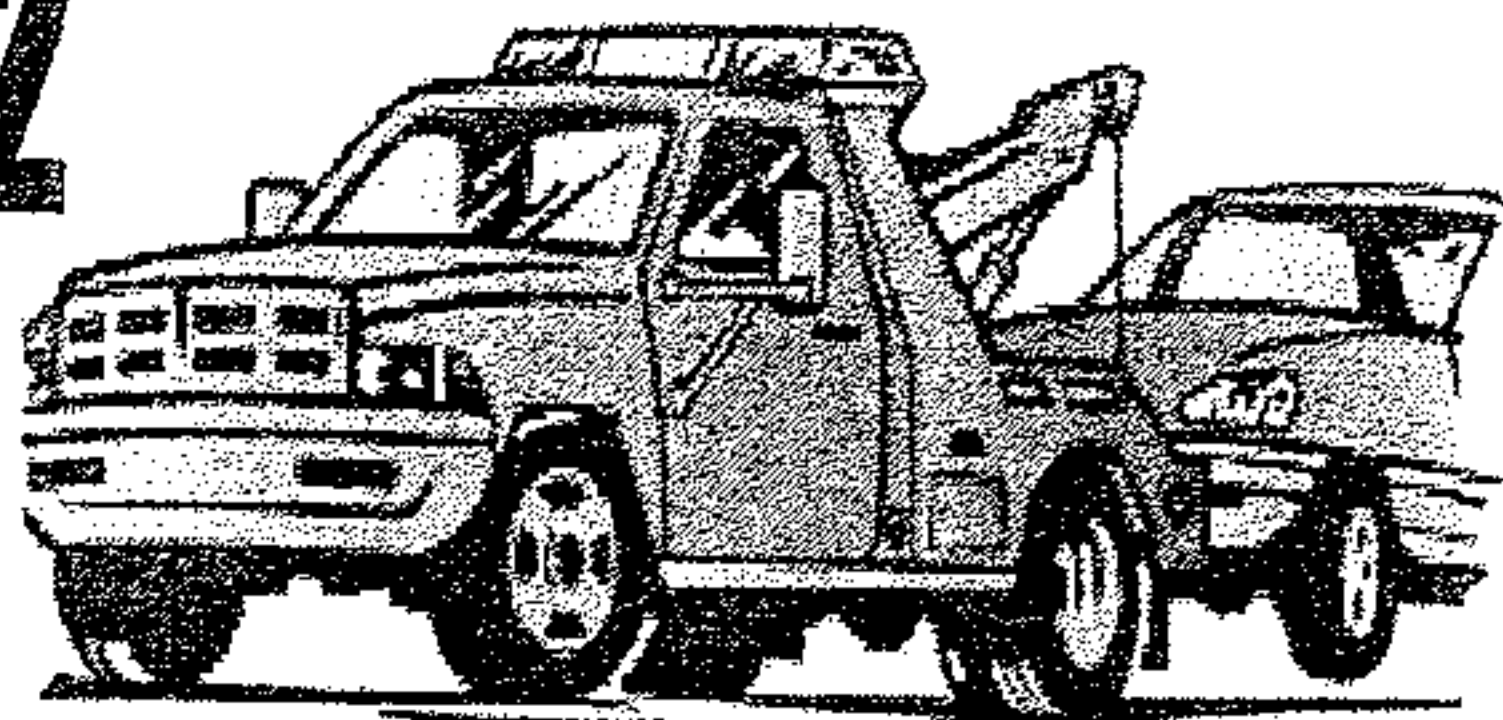

Prices subject to change with the market.

**423 337-3977**

**149 County Road 323 Sweetwater**

**Now Selling  
Aftermarket  
Body Parts at  
Discount Prices**

Prices subject to change with the market.

**Domestic**

Christopher Murrell, 47, Creekwood Circle Loudon, was charged with Domestic Assault. Officer Marty Ward LPD, was dispatched to Creekwood Circle to a domestic disturbance. Upon arrival officer made contact with the victim who advised that her and Christopher Murrell were arguing over her parents calling and coming over so late, when victim stated Murrell slammed her against the wall and choked her with his hands. Victim did have red marks around her neck. Officer spoke with witnesses, who stated he heard the two arguing and immediately went into the bed-

room and saw Murrell with his hand around victim neck. Murrell was placed under arrest and had active warrants out of Knox Co.

unwanted conc. from pg. 5

The owner showed up on scene and stated to Graves he is not to be on the property. While speaking with Graves Deputy noticed he appeared to be under the influence. Graves could not stand still and was very jittery, and sweating profusely. Deputy ran Graves through dispatch he came back revoked. Graves dis poorly on sobriety test and was placed under arrest.

**Fayette County Man Indicted for Theft and Official Misconduct**

An investigation by the Tennessee Comptroller has resulted in the indictment of Neal Halvorson, the former director of the Town of Oakland's Parks, Recreation and Cultural Arts Department, and the current athletic director at Fayette County Schools.

Investigators determined that Halvorson was simultaneously employed by both the Town of Oakland and Fayette County Schools from November 28, 2016 through January 20, 2017.

During this time, Halvorson received improper compensation totaling \$6,631.09. This included mon-

ey he was paid by the Town of Oakland while he was actually working for Fayette County Schools. Halvorson was also allowed to use a town vehicle and purchase fuel with the town's credit card while performing work for the school system.

On March 27, 2017, Neal Halvorson was indicted by the Fayette County Grand Jury on one count of theft of property, and two counts of official misconduct.

"The town of Oakland has clear policies concerning outside employment and using town property for private gain," said Comptroller Justin P. Wilson. "It's critical that government leaders provide the necessary oversight to ensure

policies are followed."

To view the investigative report online, go to: <http://www.comptroller.tn.gov/ia/>



If you suspect fraud, waste or abuse of public money in Tennessee, call the Comptroller's toll-free hotline at (800) 232-5454, or file a report online at: [www.comptroller.tn.gov/hotline](http://www.comptroller.tn.gov/hotline). Follow us on twitter: @TN-COT

**STAINED INC.**  
**TATTOO & PIERCING**  
 LENOIR CITY 865 816-6440  
 NEW OWNER • NEW ARTIST • SINCE 2011  
 521 Hwy 321 next to Vape & Stuff & Inn Of Lenoir!  
 Clean-Affordable-Quality-Custom  
 Tattoo's You've Always Wanted!

BRING IN THIS AD FOR **\$25 OFF**  
 NEW INK FOR NEW CUSTOMERS ONLY!

Check us out on FB.com/  
 Stained.Inc.Tattoo/  
[www.STAINEDINC.com](http://www.STAINEDINC.com)

**RIVER ROCK REAL ESTATE GROUP**





*Pennie Lindsey*  
 Affiliate Broker

River Rock Real Estate Group  
[www.RiverRockTN.com](http://www.RiverRockTN.com)  
 Pennie@riverrocktn.com  
 865-755-5264 - Cell  
 865-635-9706 Ext. 2 - Business

**Kelley's Tree Service**  
**Free Estimates**  
**Fully Insured**  
**865-414-3014**

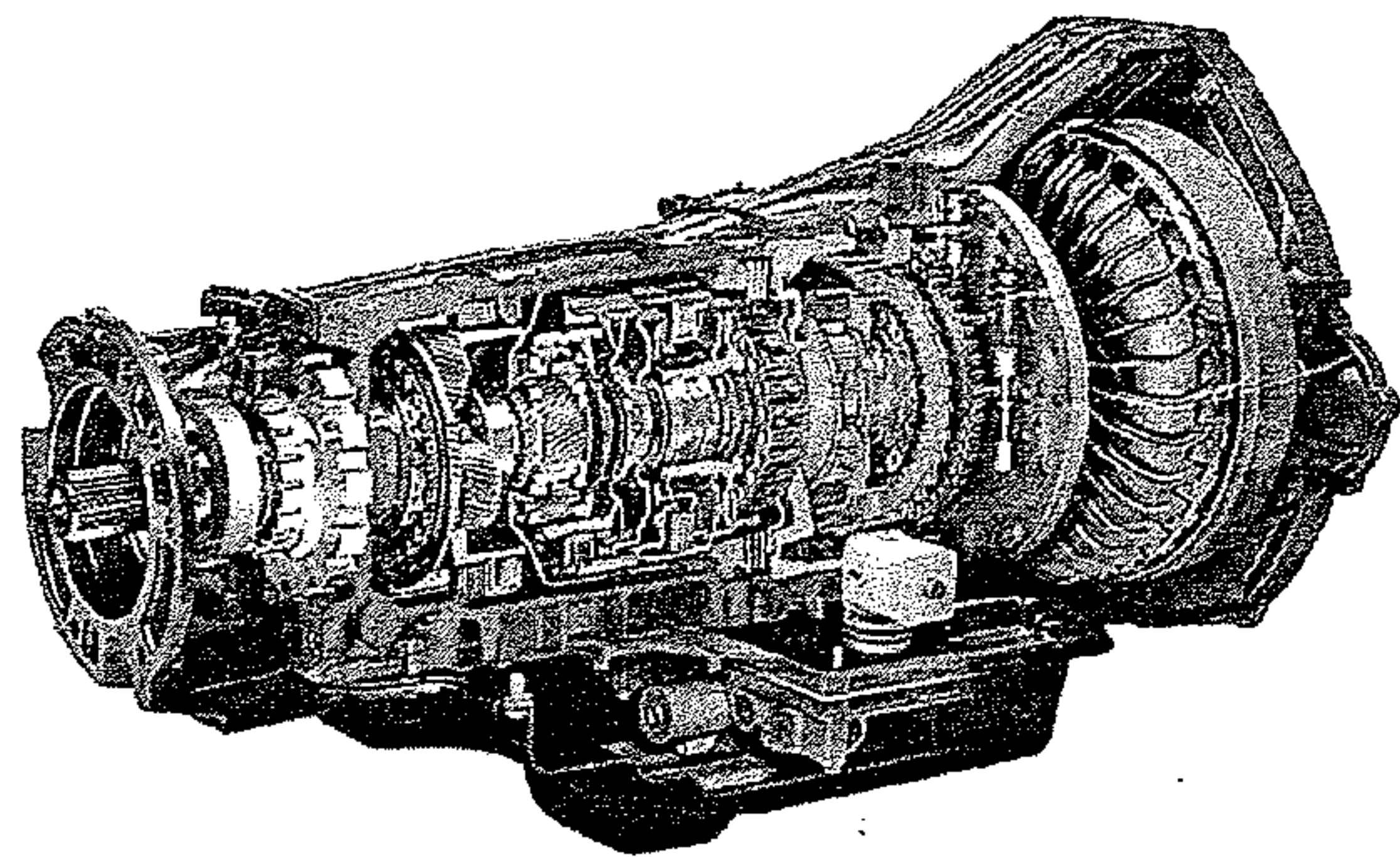
A Name You Already Know And Trust Just Got Even More Dependable  
**DEPENDABLE AUTO SERVICE, LUBE AND TIRES**  
**is Now Offering**  
**Expert, Affordable Transmission Service**  
 All ASE Certified Technicians



**We proudly welcome all New Customers and Former Advanced Transmission Customers with a 10% Discount and Any Transmission Service or Repair\***

**865-986-9359**      **865-986-5050**