

Daily Edition

Serving Loudon, Monroe and Surrounding Counties

Friday, May 6, 2016

Driver falls asleep at light; found with Heroin and more

Dakota Rogers, 21, Blacks Ferry Road Claxton, was charged with Criminal Impersonation, Driving on Revoked/Suspended License, and Man/Sell/Del/Resale SCH I & IV. Deputy Kenneth Palmer LCSO, observed a silver vehicle at the red light on HWY 11 @ Adesa Pkwy. The light turned green and the vehicle did not move

(see heroin pg. 2)

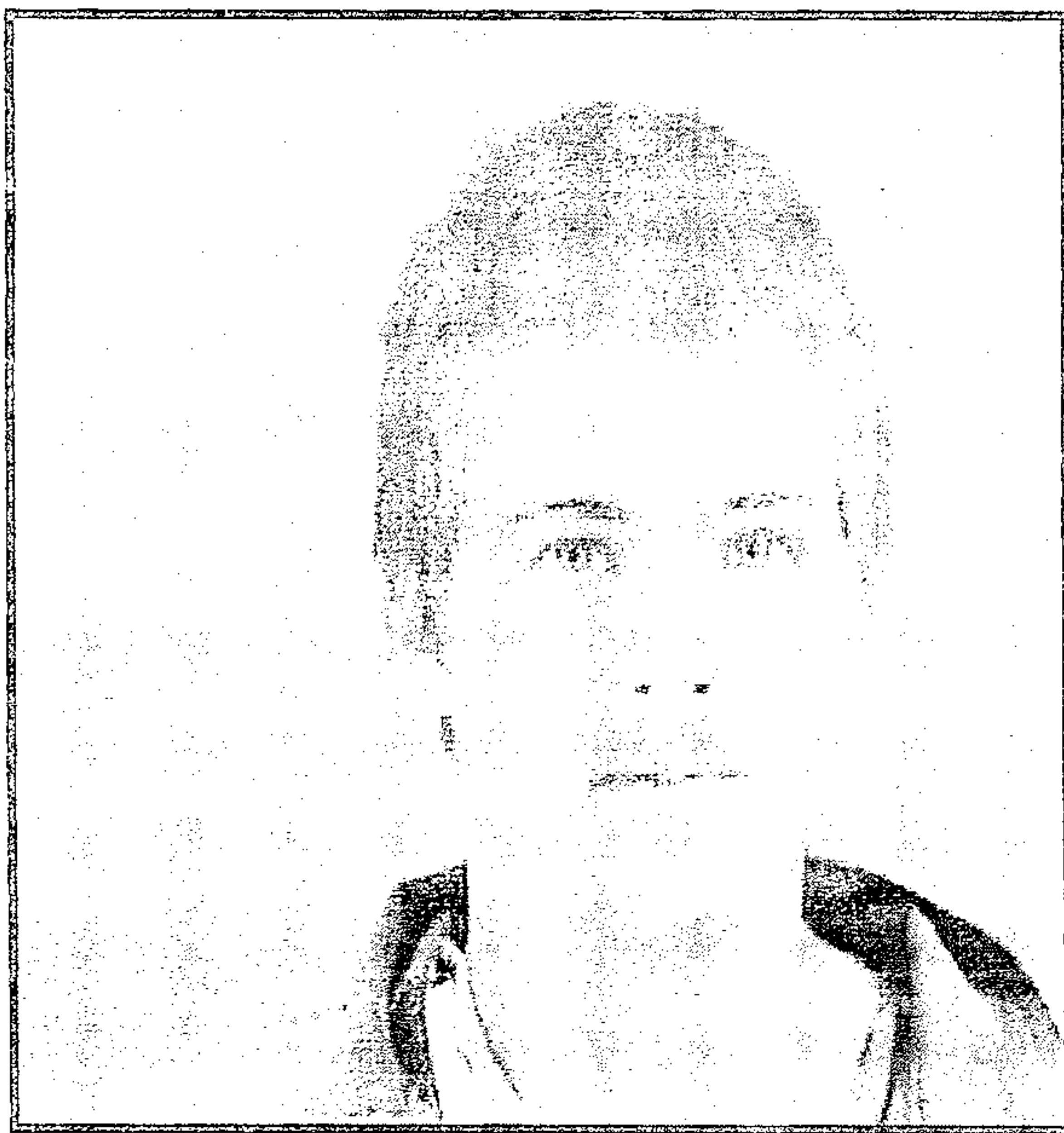

Dakota Rogers

Passed out on the roadside after wreck with damage

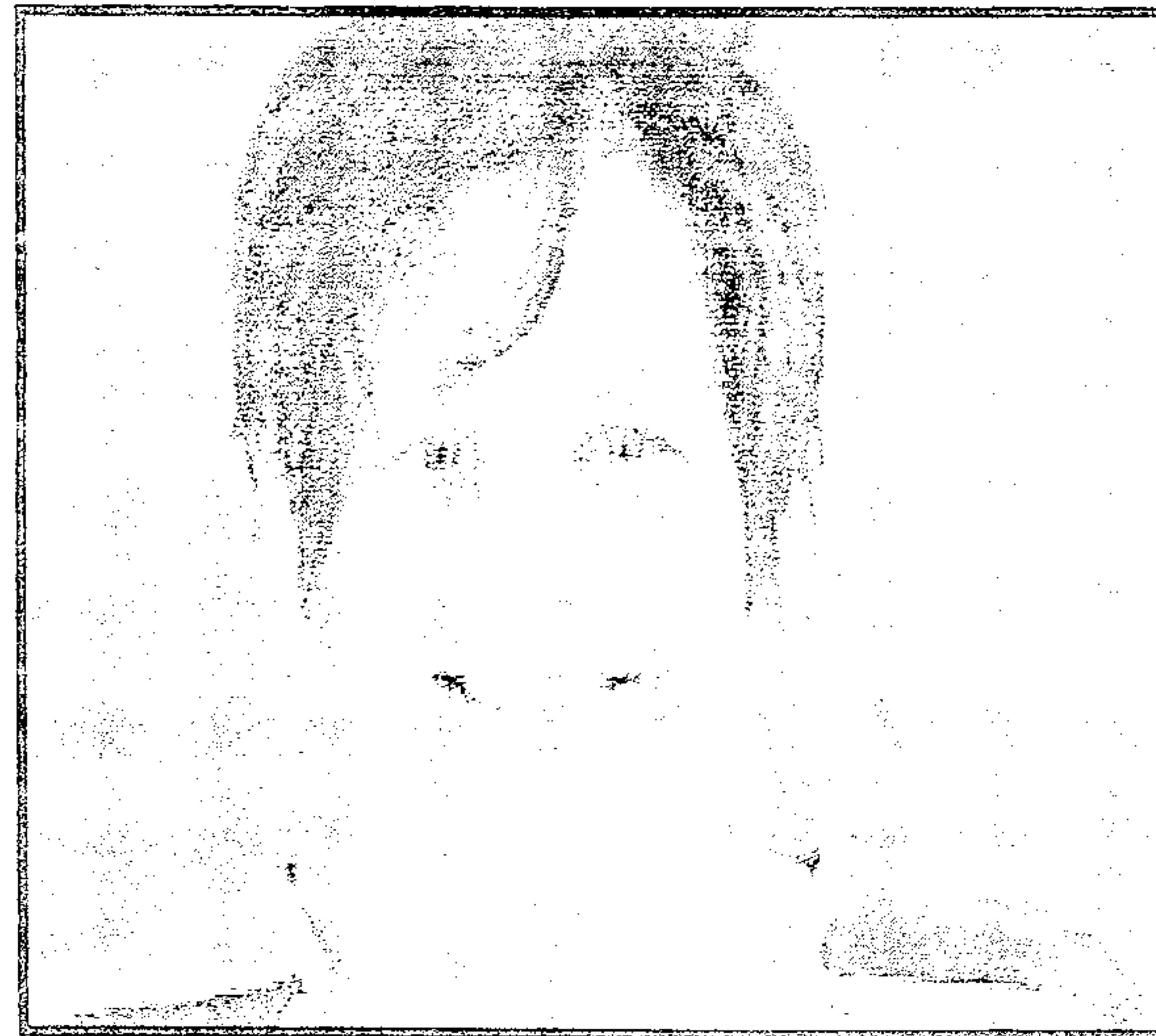

Amanda Taylor

(see DUI pg. 5)

Indicted for theft; charged at local motel

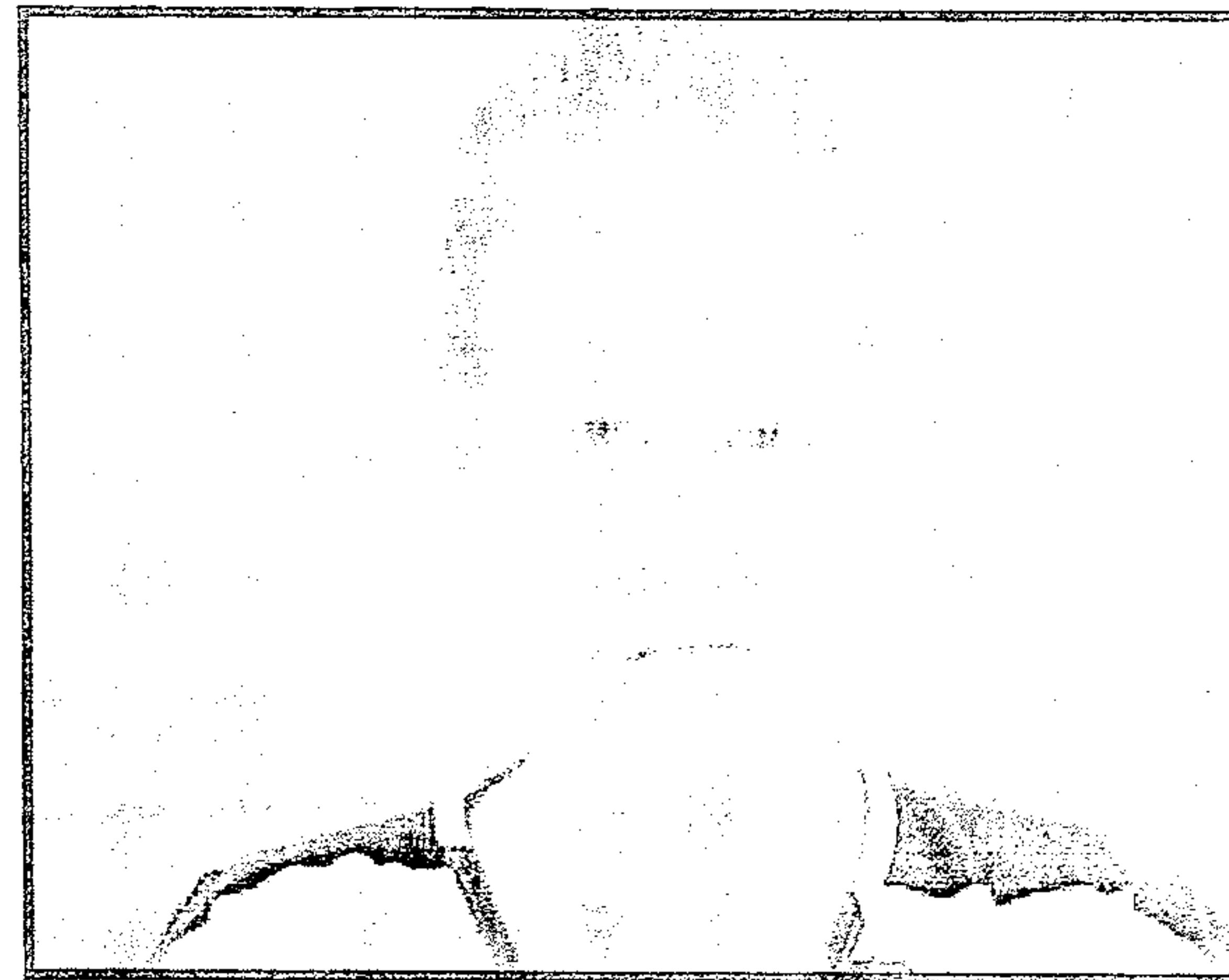

April Shaver/Moore

(see indicted pg. 3)

Former Vice President of Woods Paint Company receives 18-month sentence for evading payment of federal taxes

On May 2, 2016, Charles J. Rutherford, 44, of Johnson City, Tenn., was sentenced by the Honorable J. Ronnie Greer, U.S. District Court Judge, to serve 18 months in federal prison for his January 2016 conviction for filing false and fraudulent federal tax returns in an attempt to

(see taxes pg. 5)

Violent Criminal Apprehension Program

Part I: Sharing Information to Stop Serial Offenders

The homicide investigators, crime analysts, intelligence analysts, and administrators in the police department classroom studied their computer monitors, ready to receive instruction on—and access to—a powerful database that serves as a nationwide repository for certain types of violent crimes.

The men and women from re-

(see VCAP pg. 4)

Verse of the Day

Therefore, since we have been justified through faith, we have peace with God through our Lord Jesus Christ... — Romans 5:1

Obituaries

see inside

Wazzup

Enjoy your birthday trip to Six Flags Over Georgia Mason and Ricki! Ride them cool coasters for us all!

Weather

Today: Sunny along with

a few clouds. High 72F. Tonight: Clear. Low 47F. Saturday Partly cloudy skies. High 83F. Saturday Night A few clouds overnight. Low 58F. Sunday Partly cloudy skies. High near 85F.

Sunday Night Clear skies early will become overcast later during the night. Low around 60F. Horoscopes Taurus 4/20-5/20 Opening your heart to your unexpressed desires is the (Continued on page 6)

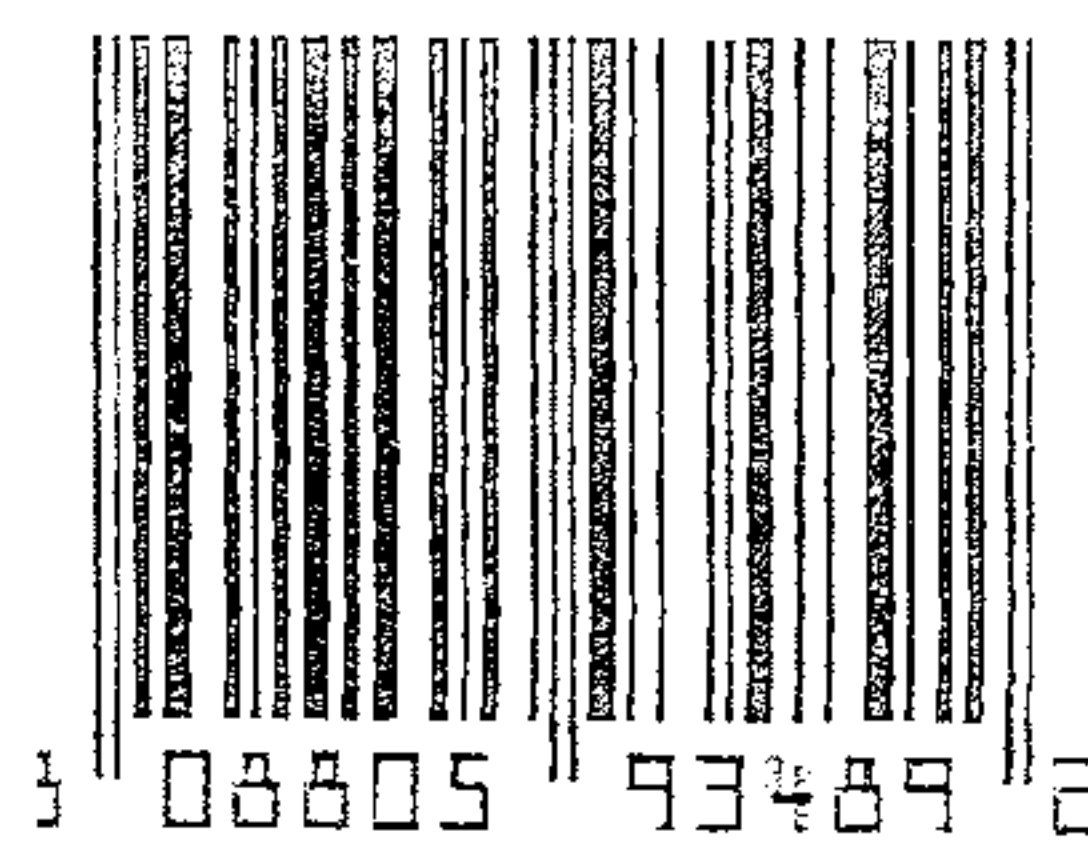

heroin

Deputy observed the driver was asleep. Deputy walked up to the vehicle and knocked on the window at which time the driver woke up. Deputy ask the driver to put the vehicle in park which he put it in drive. Deputy opened the door and told driver to put it in

park again. Deputy ask the driver to exit the vehicle, and ask for his license which he stated he didn't have it. Deputy ask for his name he told Deputy it was Joe, Deputy check though dispatch and the name didn't come back. Deputy ask for something with his name and driver handed

Deputy a ID with the name Dakota Rogers. Deputy ran the name through dispatch and it came back suspended. Deputy patted down Dakota and located a plastic baggy with a

brown powder inside, that tested positive for heroin, and a white pill and 4 green pills. Dakota was placed under arrest. Deputy Kenneth Palmer LCSO, made the arrest.

Notice: The Daily Edition does not knowingly accept fraudulent or misleading materials. The Daily Edition cannot guarantee the validity of offerings or statements contained herein. All liability for the contents of all advertising, and for any claims that may arise therefrom, is the responsibility of the advertiser or its agency. The Daily Edition reserves the right to reject, edit, or abbreviate any advertisement submitted. Advertising is accepted with the understanding that all liability for all copyright violations is the sole responsibility of the advertiser. Photographs, artwork and other copy submitted for publication is considered the sole property of the advertiser. The Daily Edition will make every effort but will not be liable for failure to publish and ad or for typographical and layout errors. All statements and information about highlights featured items, letters to the editor, herein are those solely given to the interviewer or writer and the Daily Edition assumes no responsibility of the accuracy or validity thereof. The Daily Edition will gladly reprint at no charge that part of an advertisement in which an error occurs provided a claim is made within 3 days of the first publication of the ad. Information contained in the Wazzup is received anonymously and the Daily Edition assumes no responsibility for information and reserves the right to edit or reject any and/or all submissions. The Daily Edition is a daily newspaper of general circulation in Loudon County defined under TCA 2-1-104(a)(13). The Daily Edition also serves Monroe, Knox, Anderson, Roane and Blount counties and serves 30,000 readers weekly. Send mail to PO Box 1240, Lenoir City TN 37771. 865-771-2249. email: dan1204us@yahoo.com

The Daily Edition is Loudon County's premier public interest and paid advertising paper. The Daily Edition is produced and published daily Monday through Friday and is circulated throughout Loudon County and parts of Monroe and Knox Counties. Display advertising rates \$5.00 per column inch and quantity discounts available. Call for information on upcoming promotions and events.

HACIENDA Ayala's
Mexican Restaurant
 Market Dr. * Lenoir City (In Front of Food City)

Real Authentic Mexican Food at Affordable Prices

BEST MARGARITA

You've Tried The Rest
 Now Come Have The Best!!!

We Accept ALL Competitors Coupons Outside of Mexico City!

986-3553

Good Credit OK • Bad Credit OK • Bankruptcies OK • Repo OK



2011 Honda CR-Z Low Miles, Like New, PW, PL, 6 SPD, Hybrid, Gas \$aver

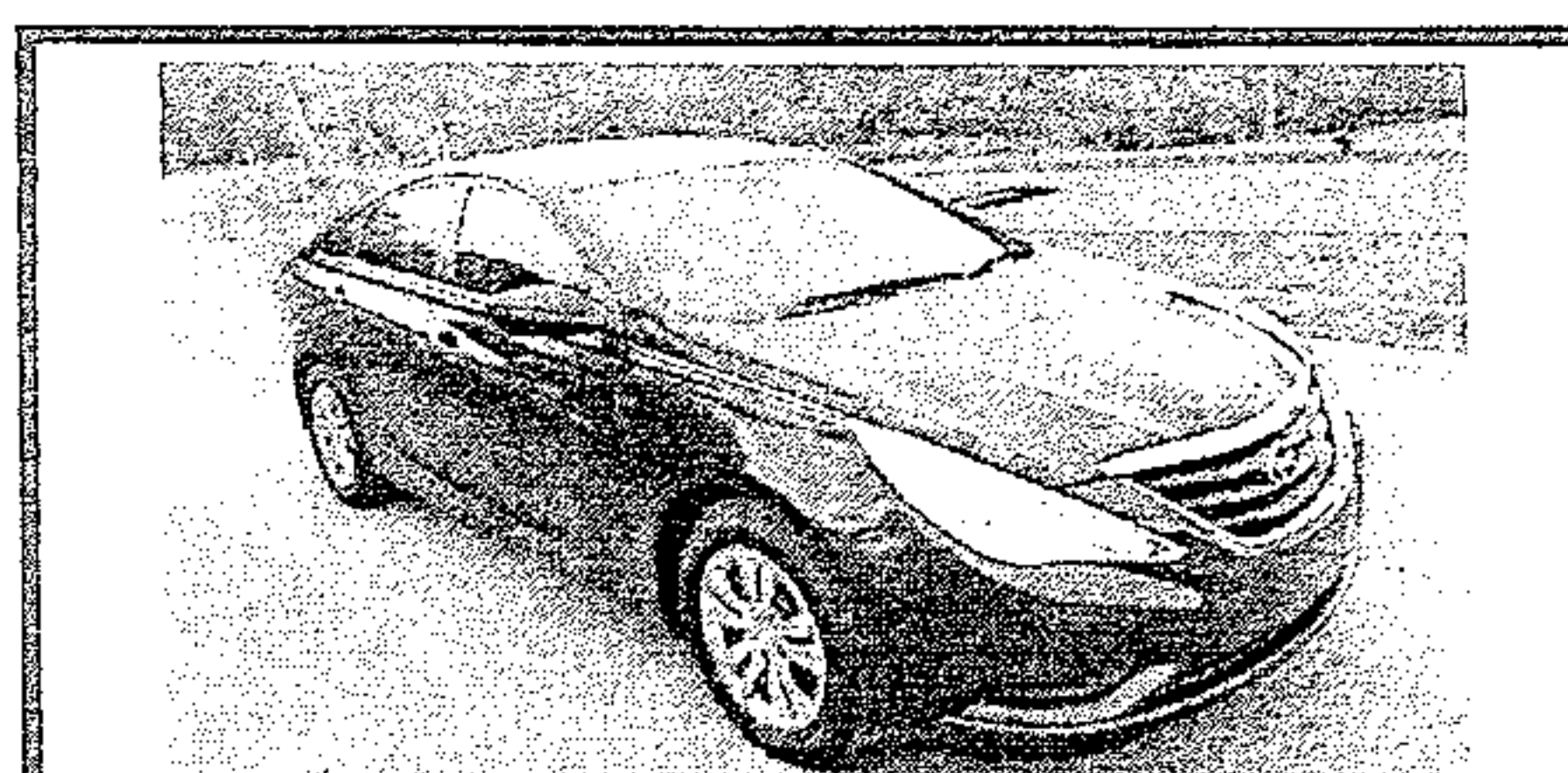

2012 Hyundai Sonata Great On Gas, A/C, PW, PL, Tilt Wheel, Keyless Entry, Like New

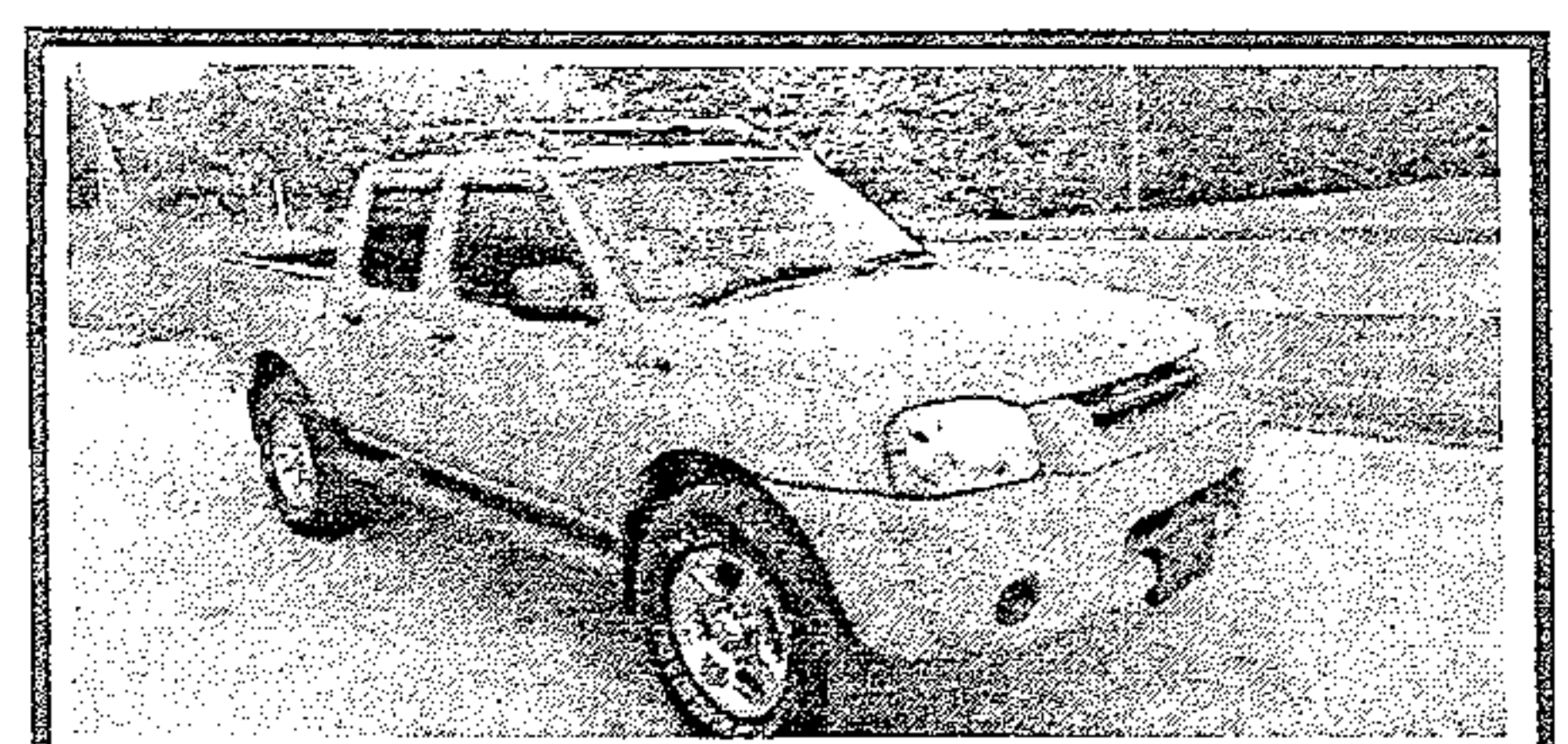

2002 Nissan Frontier 4x4, Low Miles, A/C, Luggage Rack, Quad Cab, PW, PL

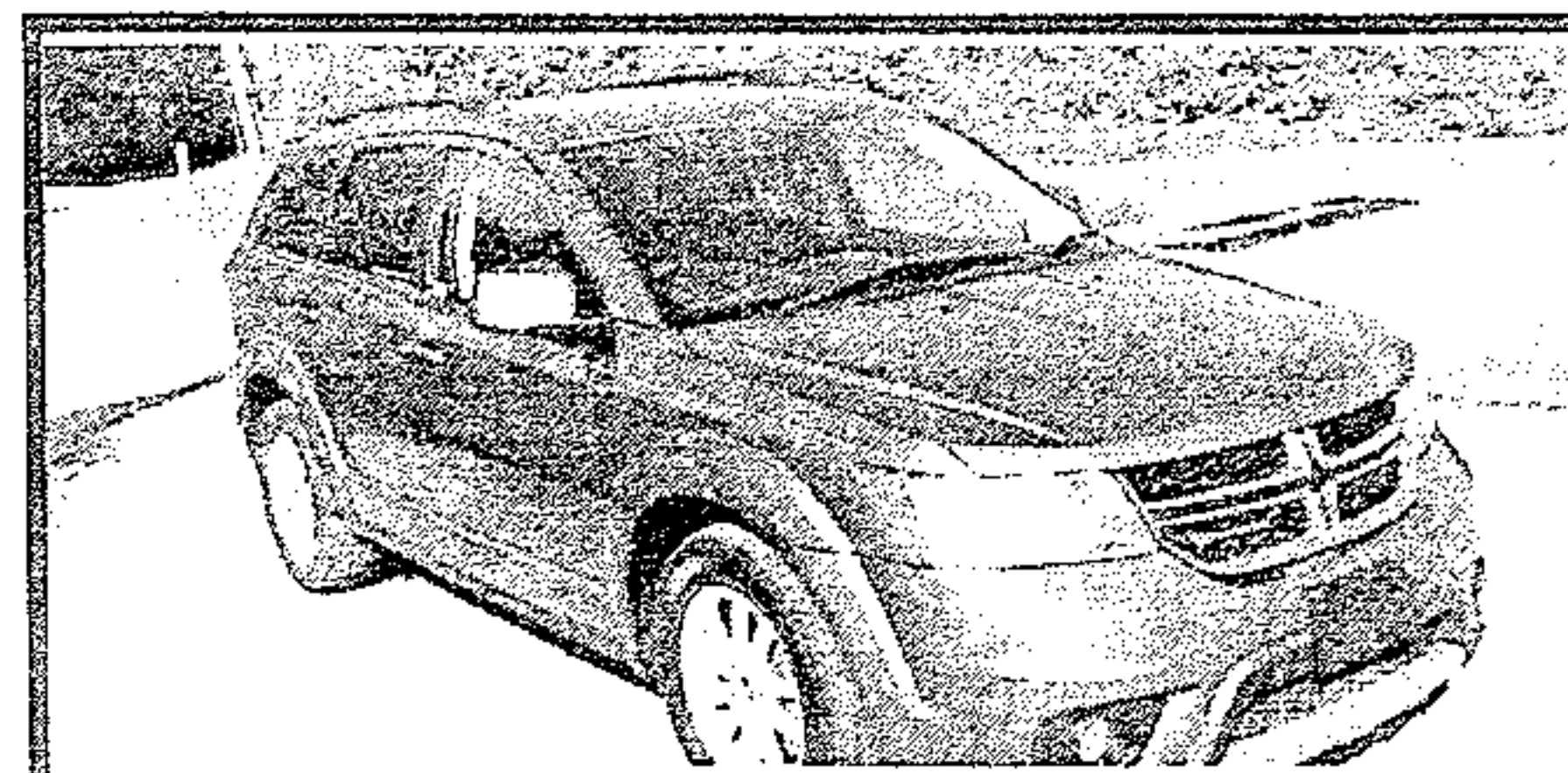

2013 Dodge Journey 3rd Row Seat, Luxurious, Climate Control Temp, Low Miles- 51k!!

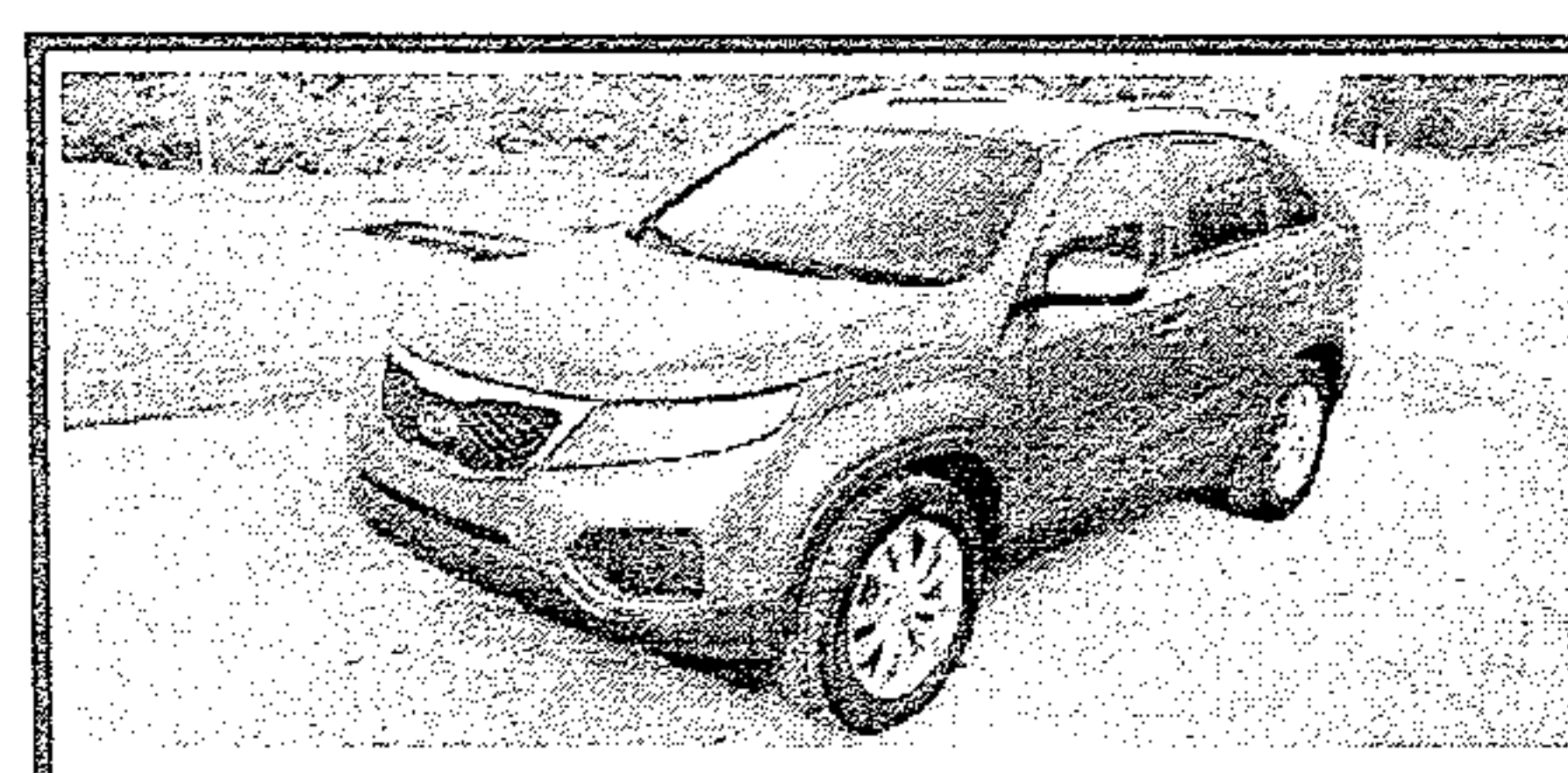

2011 Kia Sorento Spacious, 3rd Row Seat, Alloy Wheels, Sat. Radio, Luggage Rack.



2011 Dodge Grand Caravan DVD, Stow & Go, Loaded, Remote Doors, Rear A/C

DEPENDABLE MOTORS 986-9343

803 E. Broadway • Lenoir City

Serving Loudon County for 20 Years

* WAC. See Dealer for details

Visit our website at: www.dependablemotorslc.com

indicted

April Shaver, 34, C Street Lenoir City, was charged with Criminal Court Capias (theft of property).

Deputy Bobby Hamilton

LCSO, did have a warrant in hand on a April Dawn Shaver Moore. When Deputy went to The Inn Of Lenoir, he did locate Mrs. Moore and place her under arrest. The warrant was issued out of Loudon Co. Criminal Court.

For Sale: oak Wood Mulch

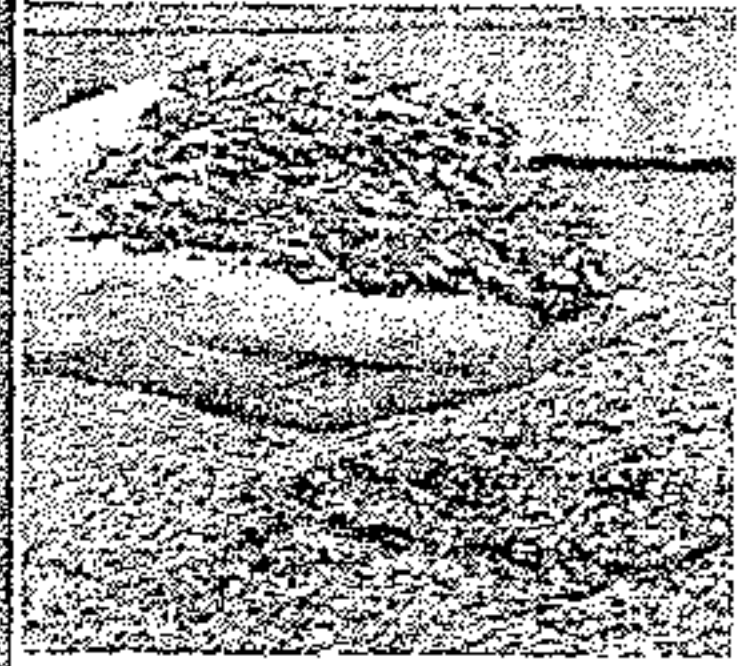

Mushroom Compost Topsoil.

Firewood

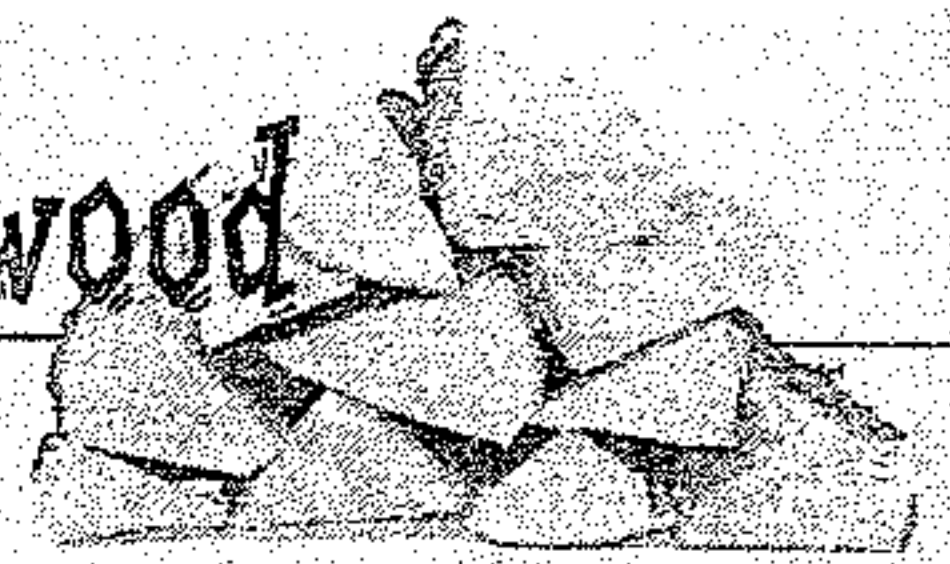

Call Steve Spoon 986-4282

To Get a Burning Permit:

Loudon (865) 986-8395
 Monroe (423) 442-7401
 Roane (865) 354-1054

The Daily Edition

serving Loudon and surrounding counties since 1986

STAINED INC

TATTOO & PIERCING

LENOIR CITY 865 816-6440

NEW OWNER • NEW ARTIST • SINCE 2011

521 Hwy 321 next to Vape & Stuff & Inn Of Lenoir!

Clean-Affordable-Quality-Custom
 Tattoos You've Always Wanted!

BRING IN THIS AD FOR **\$25 OFF**
 NEW INK FOR NEW CUSTOMERS ONLY!

Check us out on FB.com/
 Stained.Inc.Tattoo/
 www.STAINEDINC.com



BIMBO'S

Deli Open 24 Hours

865-986-9643 Call Ins Welcome

Specials

Lg. Cold Sub, bag of chips and 16 oz. fountain drink
 only \$6.29

Footlong Corn Dog \$2.59

C&C Lawn Care
 Mowing, Mulching, Trimming, Edging, Clear Debris
 Free Estimates
 Call Chad 865-271-8070

West End Storage & Warehouses
 502 Ward Avenue • Loudon
 Call 865-458-4774 or 865-679-5555

C&J Towing and Recovery
 LOWEST TOWING RATES AROUND!!!

Have you been overcharged for any type of towing service in the Lenoir City area? If you have a breakdown or accident please OWNER REQUEST C&J Towing with the officer. Also please call your Sheriff and ask him to place C&J Towing on the "Rotation List*" and help other motorists save as much as you did! We at C&J are locally owned and operated, State approved, licensed, bonded and insured. Call and let us know if your denied service or how we can be of assistance.

*note: the "Rotation List" is a list of wrecker services that provide service for wrecks, DUI's, breakdowns, etc. and are on an on-call basis for service. This list is approved by the Sheriff.

Cliff Teeters • Owner
 865-809-1661

VCAP

gional law enforcement agencies were gathered in Scottsdale, Arizona for an introduction to the FBI's Violent Criminal Apprehension Program (ViCAP), whose mission is simple: share information to help solve serial crimes.

"ViCAP Web is the only national law enforcement database that contains both investigative and behavioral information related to specific types of cases," said Rick Blankenship, an FBI crime analyst who travels the country to train law enforcement on the use of the system. "We are not looking for law enforcement agencies to enter every one of their homicides or sexual assaults in ViCAP Web," he explained. "We are looking for cases of a serial nature, where we think this may not have been the first time the offender committed this type of crime."

The detailed information entered about each of the approximately 85,000 cases in the system allows

investigators to find potential links to their own case—all while sitting at their office computers. "If you are a small police department investigating a murder case, how do you know if it's a serial crime?" Blankenship asked. "ViCAP is where you can go for help."

Investigators from across the country—many from small agencies that don't usually see violent serial crimes—can enter their cases in ViCAP Web and search the system for similarities with other cases. Did the offender pose the victim in a particular way? Did he choose a particular kind of victim, like a prostitute or an elderly person? Were certain items removed from the crime scene? Was DNA recovered? If the database shows that a peculiar sexual homicide in Chicago was similar to a previous case in upstate New York, for example, it might provide investigators from both jurisdictions with new leads and possible suspects.

"A lot of times lo-

cal law enforcement gets involved in a case and they hit a wall where they don't have any more leads," said Thomas E. Kelly, chief of the Apache Junction Police Department near Phoenix, who has been using and promoting the database for several years. "ViCAP Web allows investigators to compare incident details with thousands of other cases. And every time a new case comes into the system, it's compared to the case that you submitted, so cases are constantly being reviewed for any connections."

Nearly 5,500 U.S. law enforcement agencies participate in the program. Cases that meet the ViCAP criteria—including homicides and attempted homicides, sexual assaults, missing per-

sons, and unidentified human remains—are entered and include details about the crime, the victim, and whatever is known about the offender. The database can be searched using various keywords and filters. If an investigator is working a murder case where the victim was shot, stabbed, and bound, he can search ViCAP Web for cases where victims were killed in the same way.

ViCAP analysts like Blankenship and Christie Palazzolo, who also provided instruction at the recent Arizona training, specialize in violent serial crimes and monitor the database with their colleagues from their FBI offices in Virginia. They regularly provide consultative and analytical services to

investigators.

"Many smaller agencies might not have crime analysts," Blankenship said. "When they come across one of these types of cases, they can place it in ViCAP and it gives them the opportunity to use our resources. We can do the analytical work for them and provide investigative leads and contacts with other agencies who have similar cases."

Blankenship added that ViCAP Web is a free service provided by the FBI and is open to law enforcement agencies nationwide. The only "cost" for training and access to the system is that participating agencies must enter their criteria cases so that the database continues to

(see VCAP ctd. pg. 7)

Public Notice

The Loudon County Salary and Benefit AD-HOC Committee will meet May 9th, 2016 9:00 am at the County Office Building to discuss medical insurance.

**Kelley's
Tree
Service**
Free Estimates
Fully Insured
865-414-3014

BUDGET
Transmissions

302 S. Northshore Drive Knoxville
(865) 584-4391 budget-transmissions.com

Why Buy From Budget?
Free Towing From Lenoir City or Loudon County
20 Years of BBB Zero Customer Complaints Award Member
A+ Plus Rated
Huge Transmission Inventory
Best Technicians Period!!!
Call (865) 584-4391 Today!





The Collision Center Inc., is locally owned and operated by Stan Ledbetter and Jake Tillett. Along with their staff, they have over 136 years of combined experience in the collision repair business.

After working for *Knoxville Collision Center* for years before it was sold to an out of state corporation, Stan and Jake have fulfilled their dreams of owning and running their own shop.

"We are a family of past co-workers who have been together for 15 years. We support ALL our military and are ALL VOL! Stop by and see us and you will know with us *"Quality is not an option it is the only standard we will accept."*

The Collision Center, Inc.
10439 Lexington Drive
Knoxville, TN
865-288-7919



DUI

Amanda Taylor, 29, Melody Lane Maryville, was charged with Poss. of Drug Para., Leaving the Scene of Accident Property Damage, Simple Possession, Violation of Implied Consent, and DUI.

According to the report, Trooper Paul

Clendenen THP, was dispatched to a crash on Ford Road. The driver Amanda Taylor, had been at a friend house. Amanda had got into an argument, left the residence and crashed into a fence, and then drove back to the friends house. Amanda then left on foot and was located

unconscious on the side of the road and did not regain consciousness until given a sternal rub. At the hospital Trooper noticed an odor of intoxicant coming from her person. Amanda admitted to drinking 2 beers, smoking marijuana, and taking anti-depressant. Trooper ask for con-

sent to blood draw Amanda refused. Amanda have given consent to search her bag, Trooper located a marijuana pipe, and 11 SCH. II Adderall pills. The pills were not prescription bottle but a plastic wrapper. Amanda was placed under arrest. Trooper Paul Clendenen THP, made the arrest.

taxes evade and defeat paying income tax.

From 2006 through 2014, while serving as vice president of Woods Paint Company ("WPC") in Bristol, Tenn., Rutherford embezzled approximately \$1 million by paying his own personal expenses out of company accounts. Although the funds were stolen, he was obligated to report the embezzled money as income on his federal individual income tax returns, which he failed to do for tax years 2008 through 2013. By filing false and fraudulent returns, he evaded paying well over \$200,000 in federal taxes. In addition to his prison sentence, he was also ordered to pay over \$1.2 million in restitution, to both WPC and the Internal Revenue Service (IRS). Rutherford will also be prosecuted in state court for theft.

This investigation was conducted jointly by the Sullivan County Office of the District Attorney General, City of Bristol Tennessee Police Department, and IRS-Criminal Investigation Division. Assistant U.S. Attorney David Gunn represented the United States.

"The IRS enforces the nation's tax laws, but also takes particular interest in cases where someone, for their own personal

(see taxes ctd. pg. 7)

PURDY'S AUTO PARTS AND SALVAGE
WE BUY SCRAP IRON • COPPER • BRASS • ALUMINUM

\$ **Paying Top \$\$\$**
Call For Latest Prices

You Name It, We Buy It!

Radiators, Wheels, Batteries, Appliances, Farm Equipment

Copper
Paying Top \$\$\$
Call For Latest Prices

Complete Cars
per 100 lbs.

Scrap Metal
Paying Top \$\$\$
Call For Latest Prices
per 100 lb

We Buy Batteries

Aluminum Cans
Paying Top \$\$\$
Call For Latest Prices

Now Selling
Aftermarket
Body Parts at
Discount Prices

You Call We Haul!

423-519-5402

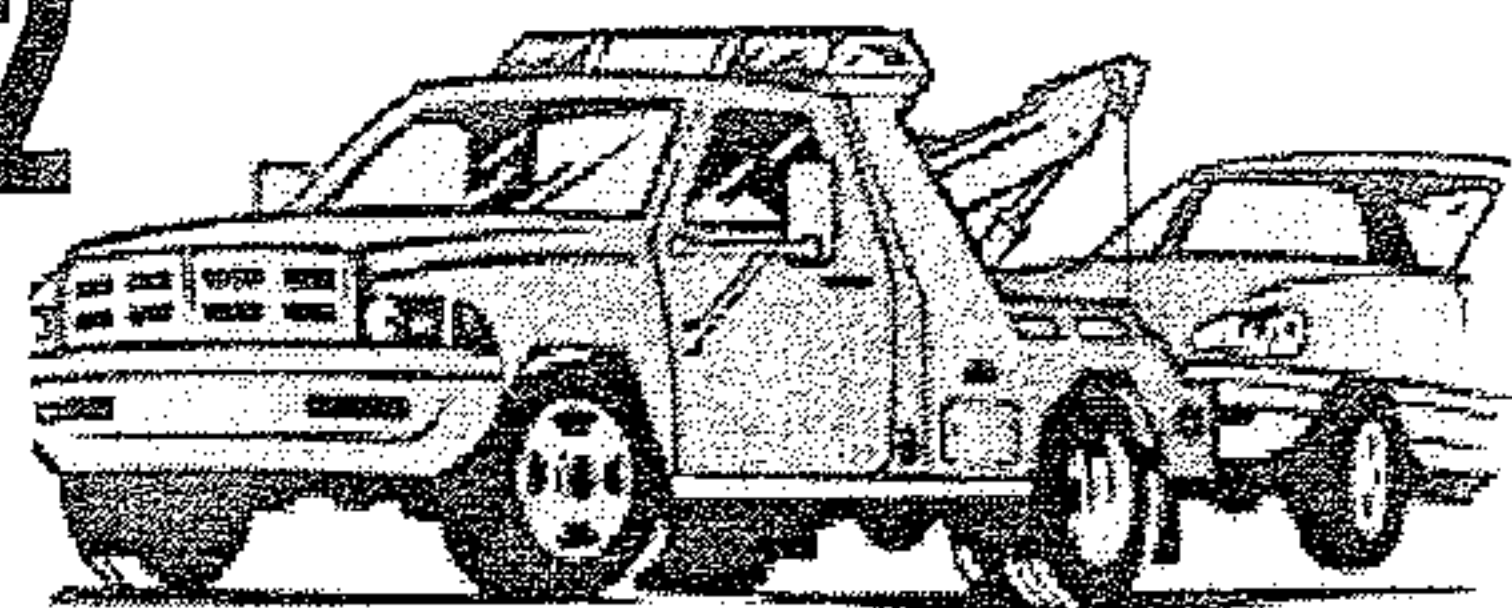

* Prices subject to change with the market.

423 337-3977

149 County Road 323 Sweetwater

* Prices subject to change with the market.

VCAP expand. At the training session in Scottsdale, law enforcement personnel learned about the system by entering their cases. An officer from Flagstaff brought a cold case homicide from his department. A deputy from a different jurisdiction entered her sexual assault case. A detective from the Scottsdale Police Department who was familiar with ViCAP because of a murder case he has been working for the past year (see first sidebar) encouraged his colleagues to receive the training and get access to the database. "We are constantly looking for more agen-

cies to join ViCAP," Blankenship said. "When we go out and train law enforcement personnel and they see what ViCAP can do and how easy it is to get the information into the system, they get excited about being able to move their cases forward." In addition to the database, which is a part of the FBI's National Center for the Analysis of Violent Crime (see

second sidebar), FBI analysts offer a range of other free services to help investigators. "There's more than just the database," said Kelly, the Apache Junction police chief. "We had an unidentified victim where we just had skeleton remains. My crime scene technician contacted the Bureau, and they did a facial reconstruction. With a likeness of the victim, we then

reached out to the media and asked for the public's help to identify her. Once you are in the program," he noted, "there is a lot of help available." "The bottom line," Blankenship said, "is that we are all in this together. The more resources you can throw at solving a crime, the better your chances are of solving it. We want law enforcement agencies to know that we're

here to help them, and we want the public to know that these cases are not forgotten. There's always the possibility that the newest case that comes in will match up with a case from five or 10 years ago," he explained. "We want the public to know—especially the families of victims—that we are constantly looking at these cases."

Public Notice

There will be a Special Called Executive Session 5:00 Monday, May 16, 2016 at the County Office Building to discuss pending and future litigations on the Niles Lawsuit

Public Notice

The Loudon County Salary and Benefit AD-HOC Committee will have a special called meeting May 16, 2016 5:30 at the County Office Building to discuss medical insurance.

LOOK!

\$75 Weekly Payments

LOOK!

MARTY'S AUTO SALES • 986-2222 • MARTY'S AUTO SALES • 986-2222 • MARTY'S AUTO SALES • 986-2222 • MARTY'S AUTO SALES • 986-2222 • MARTY'S AUTO SALES •

Bad Credit
Divorce
Fixed Income
Repos
Bankruptcy
No Credit

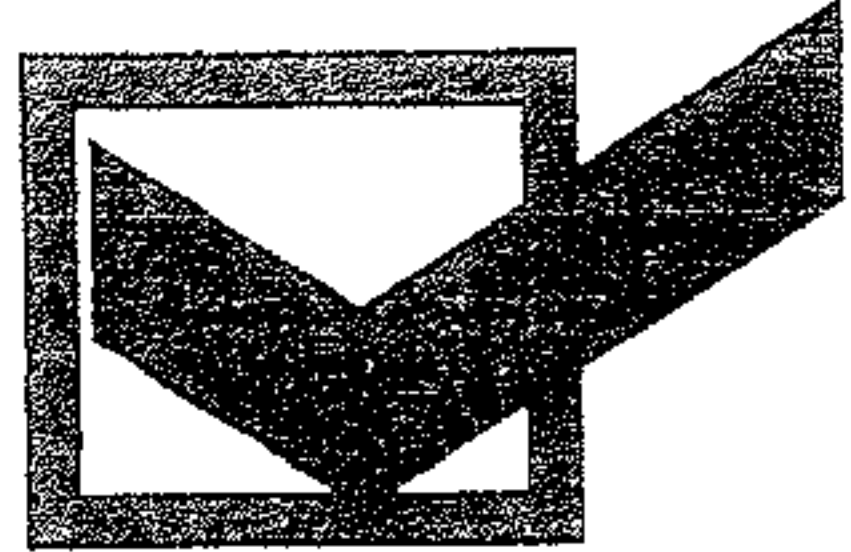

APPROVED!

Visit Us On The Web At:
martysautosales.net

NO CREDIT CHECKS

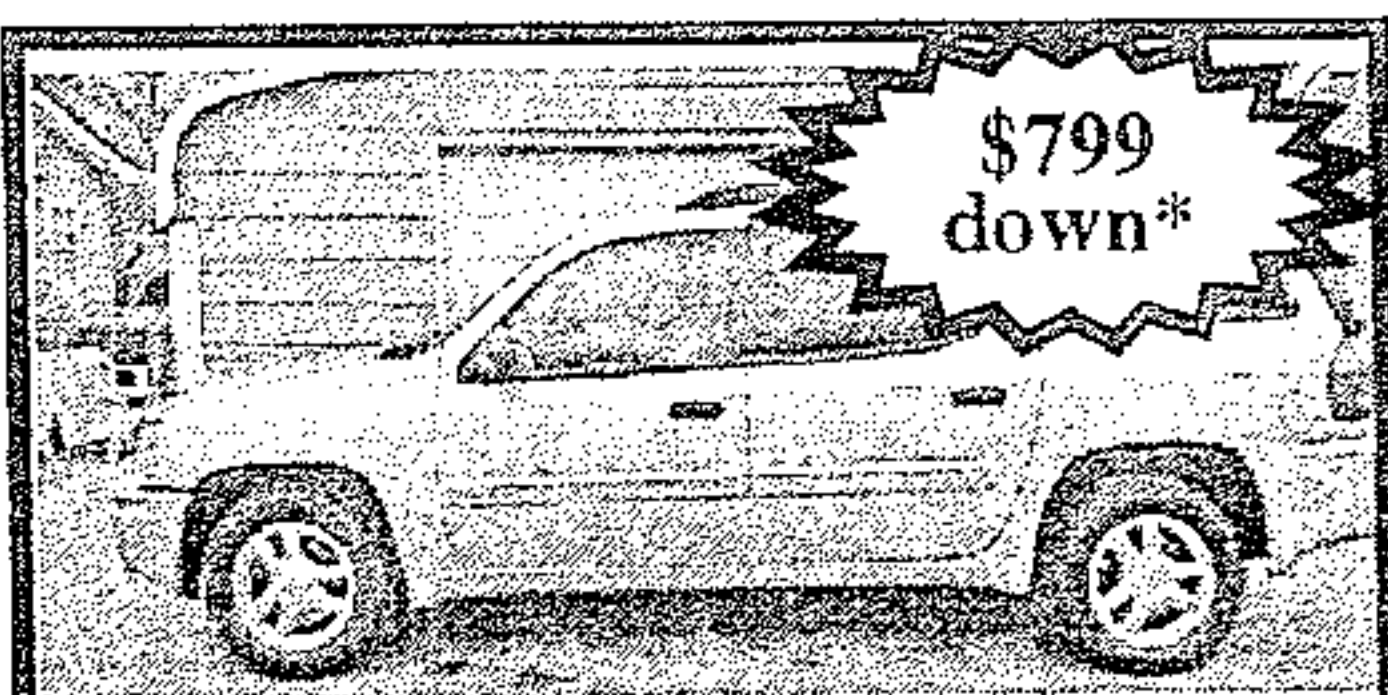

\$799 down*

04 Envoy, 3rd row, Runs Great Only \$799 down *

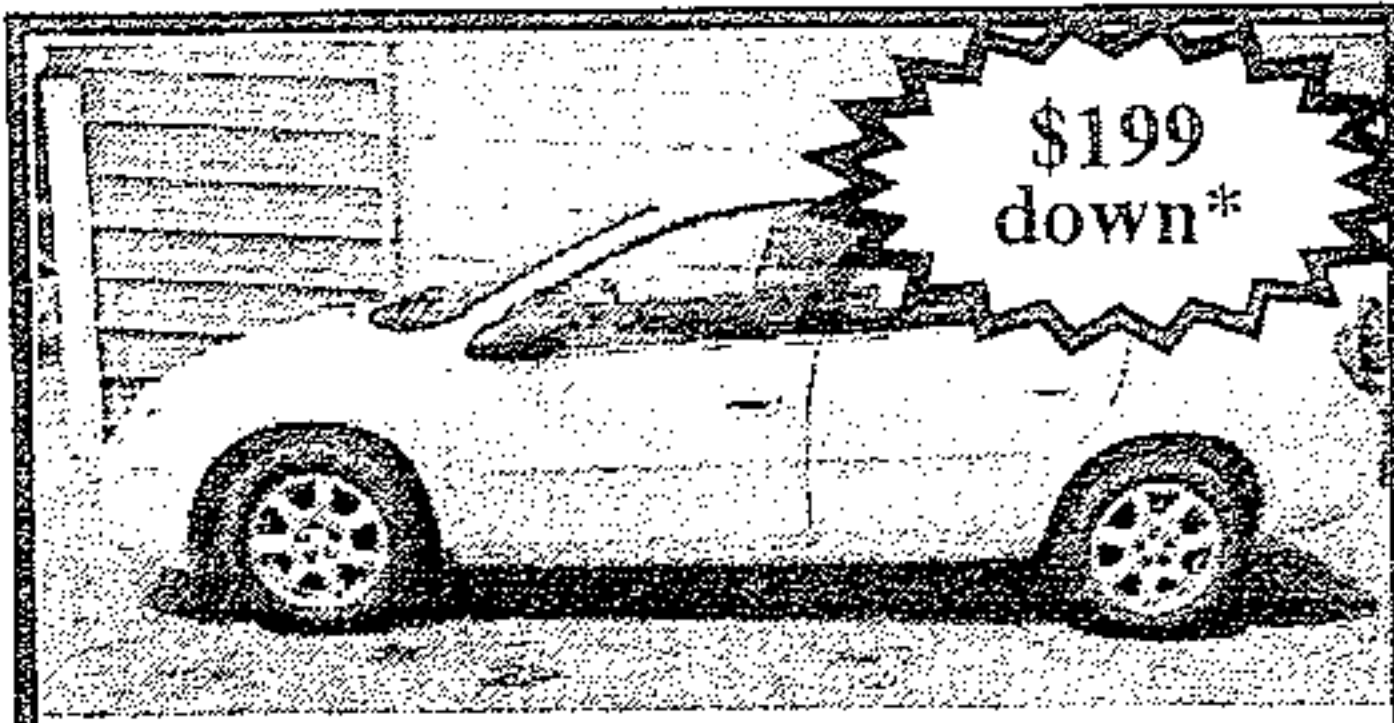

\$199 down*

04 Neon, Auto, Runs Great, Only \$199 down *

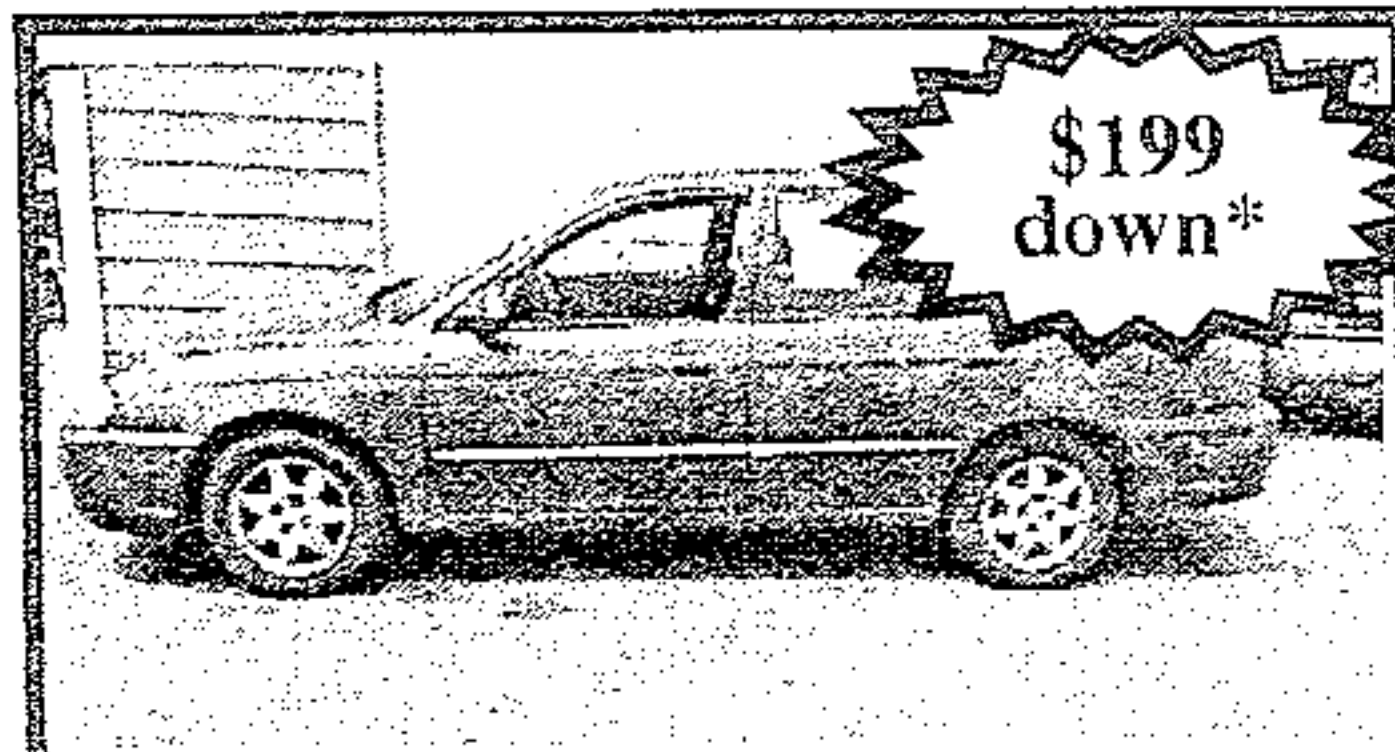

\$199 down*

02 Spectra, auto, Runs Good, Only \$199 down *



\$799 down*

05 XL7, auto, 4x4, NICE!!! Only \$799 down *

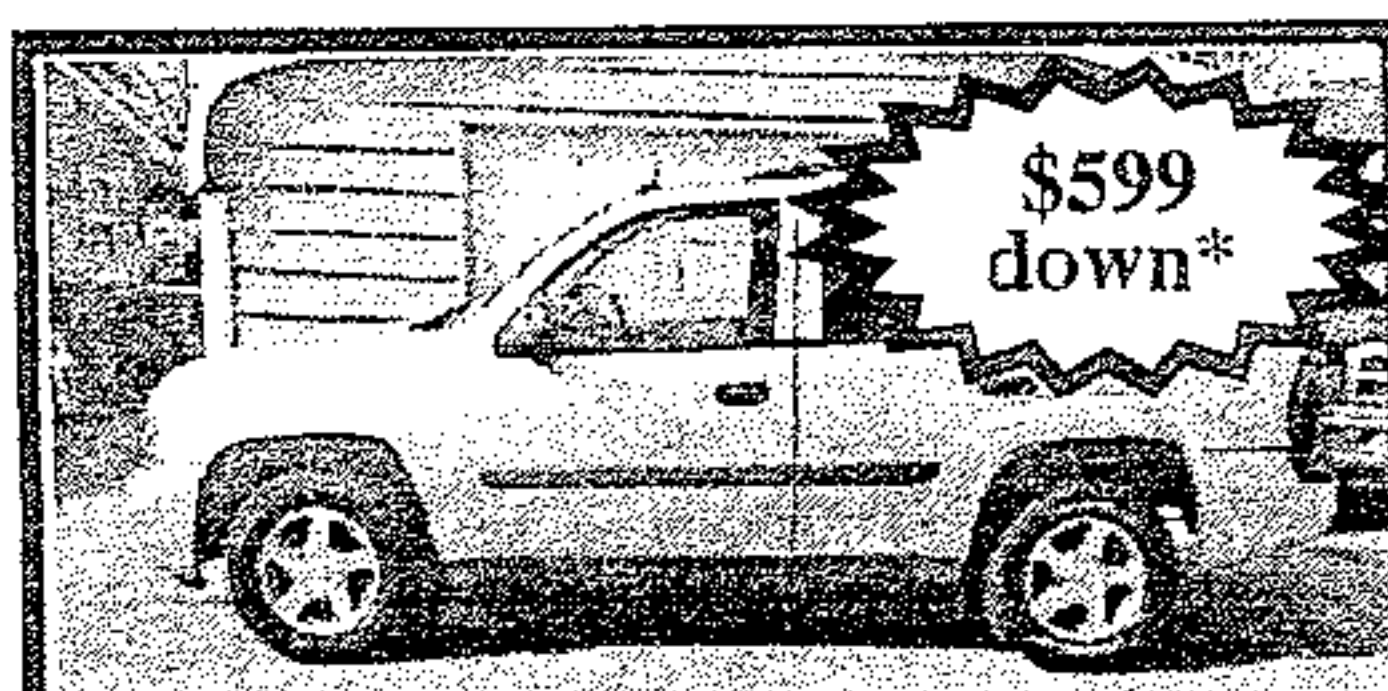

\$599 down*

05 Trailblazer, auto, good miles Only \$599 down *

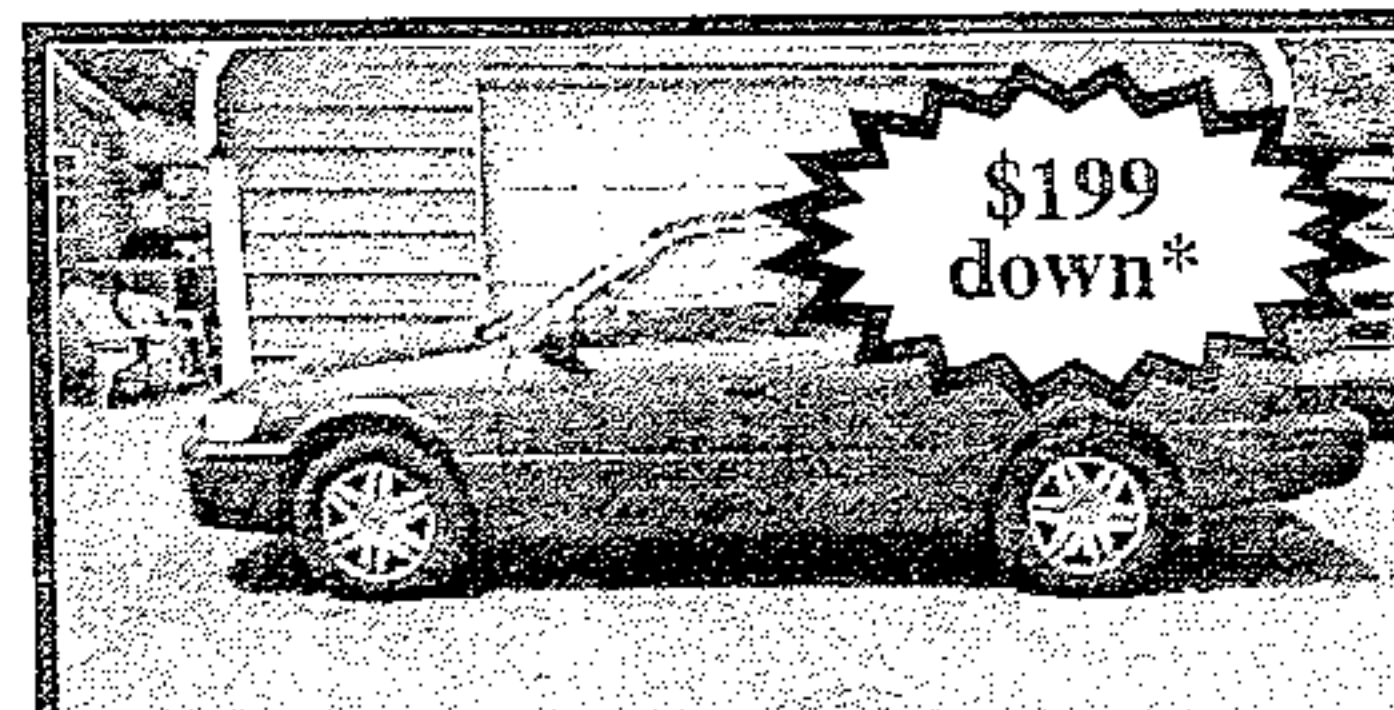

\$199 down*

01 Camry, auto, cold AC, Only \$199 down *

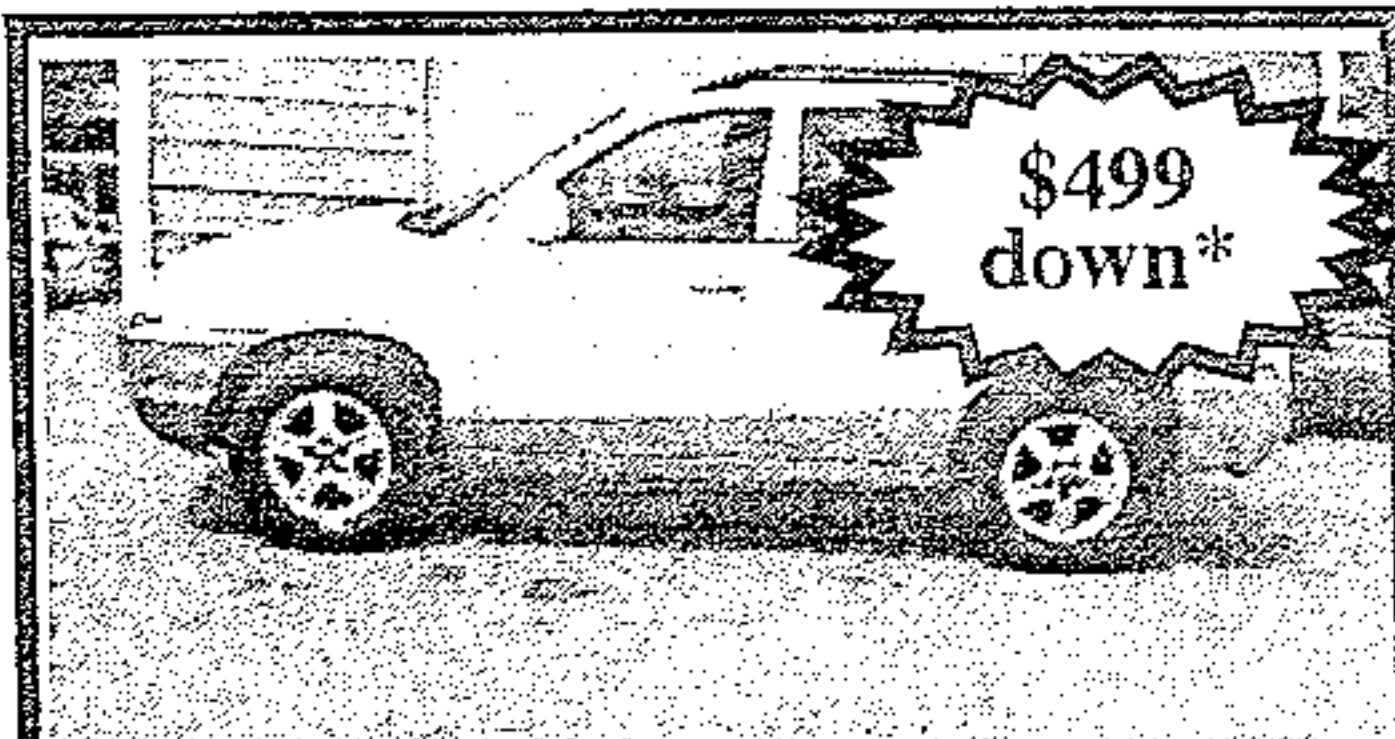

\$499 down*

03 Santa Fe, auto, V6 Only \$499 down *

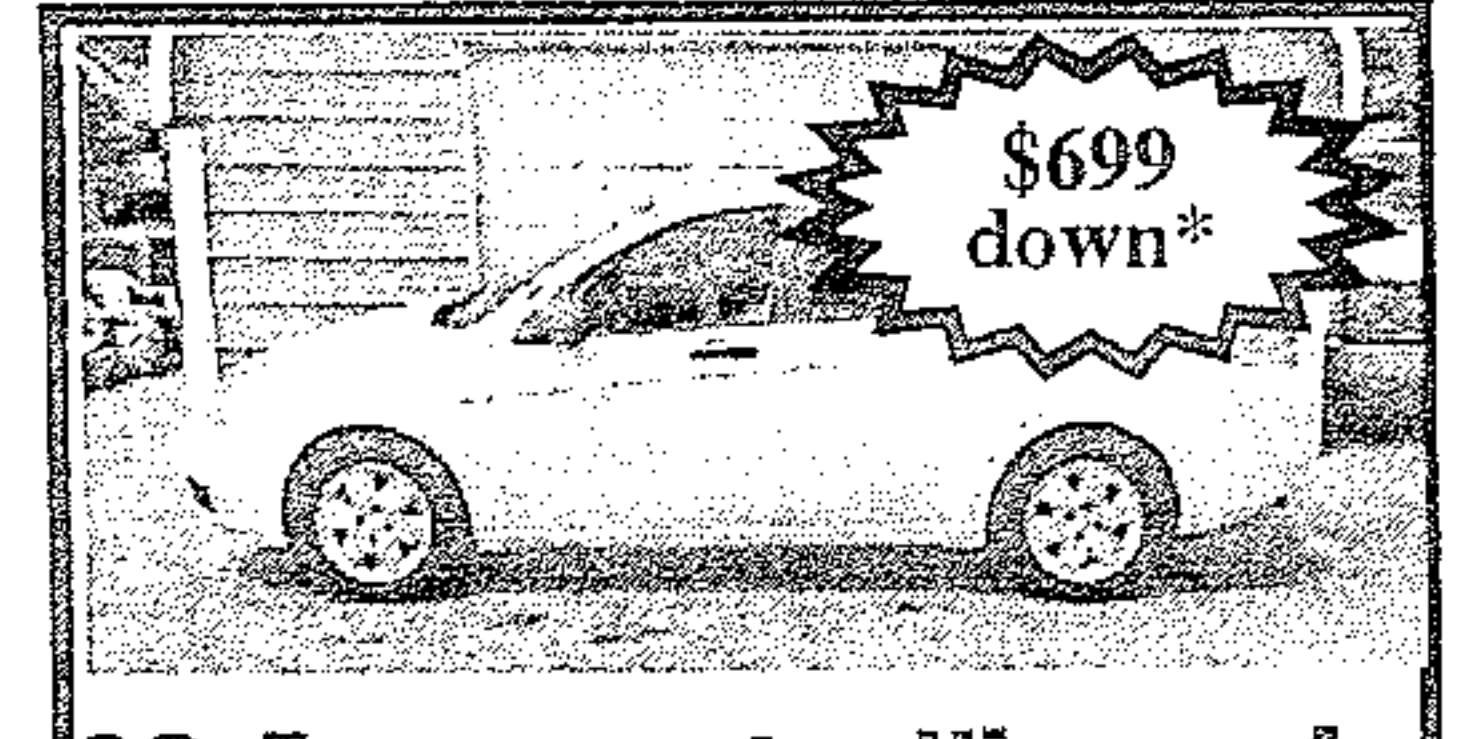

\$699 down*

09 Focus, auto, Nice only \$699 down *

NO Credit Checks

Marty's Auto Sales
986-2222

Se Habla Español

100% Approval*

*See Dealer for details. All down payments plus tax, tag, title and fees.

MARTY'S AUTO SALES • 986-2222 • MARTY'S AUTO SALES • 986-2222 • MARTY'S AUTO SALES • 986-2222 • MARTY'S AUTO SALES • 986-2222 • MARTY'S AUTO SALES •

taxes etd. from pg. 7 benefit, has taken what belonged to others," stated Tracey D. Montano, Special Agent in Charge of the IRS-Criminal Investigation Nashville Field Office. "No matter what the source of income, all income is taxable. The

prosecution of individuals who intentionally conceal income and evade taxes is a vital element of the IRS' enforcement strategy. We are pleased with the successful resolution of this investigation."

Is Your Washer Broken?

Call Me
I Only Charge \$100 Period!!!
Call Allen
865-617-7113

THE RELIC SHOP

521 Hwy 321 Lenoir City Suite 3
next to Stained Inc and the Inn of Lenoir
865-250-9280
ANTIQUE GUN SALE
CIVIL WAR SMITH CARBINE (EXTRA RARE)
1861 COLT ARMY & 1862 REMINGTON ARMY
LATE 1700'S FLINTLOCK PISTOL
MUZZLELOADERS AND MORE

A Name You Already Know And Trust Just Got Even More Dependable
DEPENDABLE AUTO SERVICE, LUBE AND TIRES
is Now Offering
Expert, Affordable Transmission Service

All ASE Certified Technicians

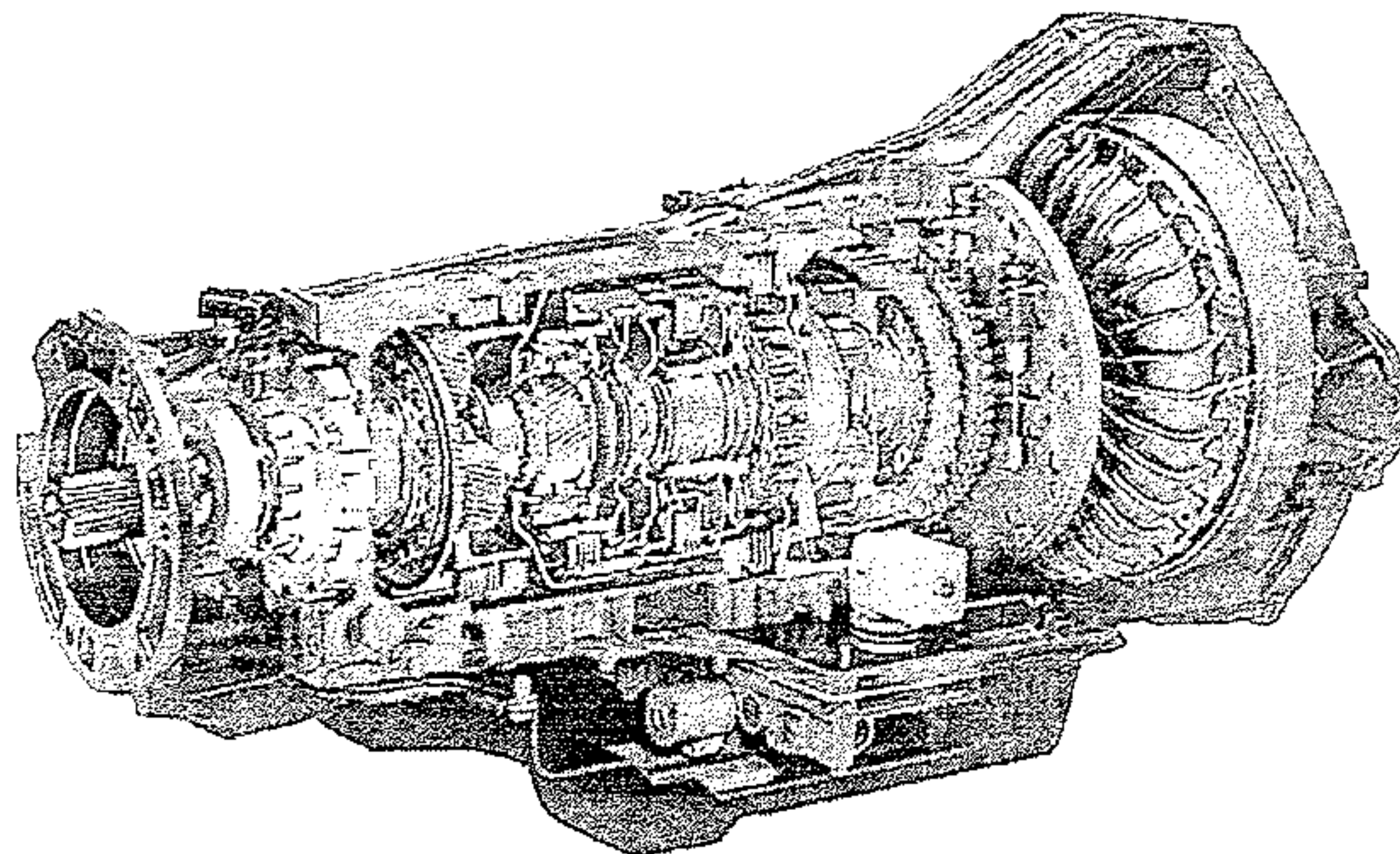

We proudly welcome all New Customers
and Former Advanced Transmission
Customers with a 10% Discount and Any
Transmission Service or Repair*

865-986-9359

865-986-5050

Bad Credit, No Credit OK!!! We Finance Everybody!!!
Low Down Payment!!! We Are The Bank!!!

Over 100 Cars, Trucks & Vans in Stock - Warranties On ALL Vehicles Sold!!!

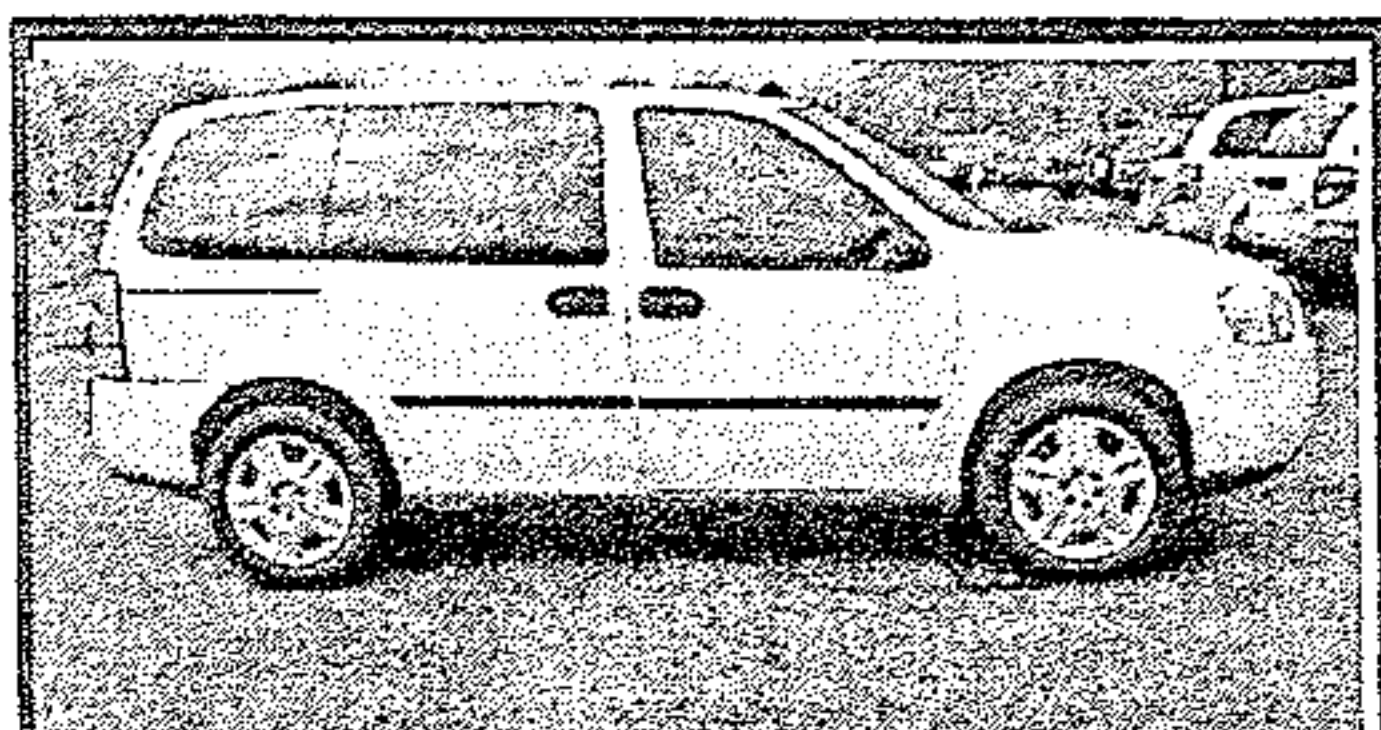

2007 Chevrolet Uplander,
60k miles, NICE!!!

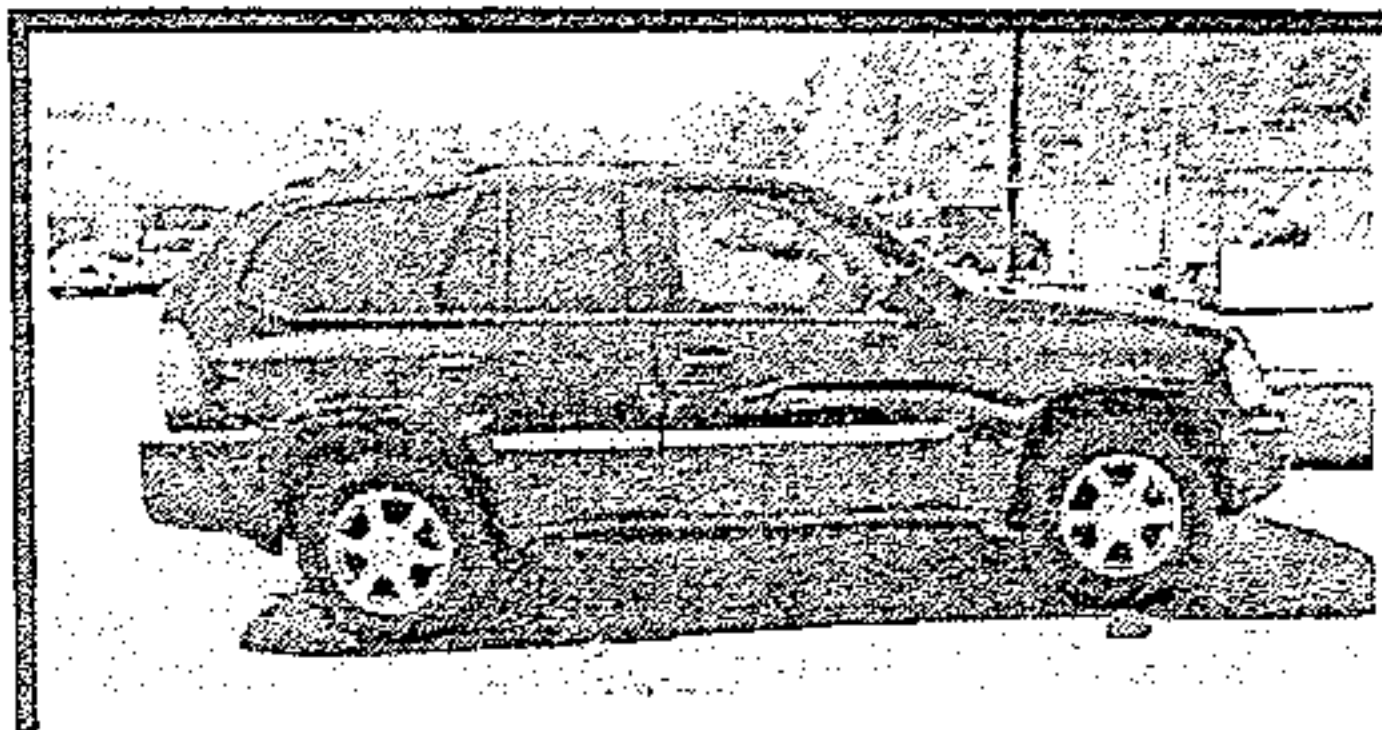

2008 GMC Envoy, Nice Clean,
Great Mileage

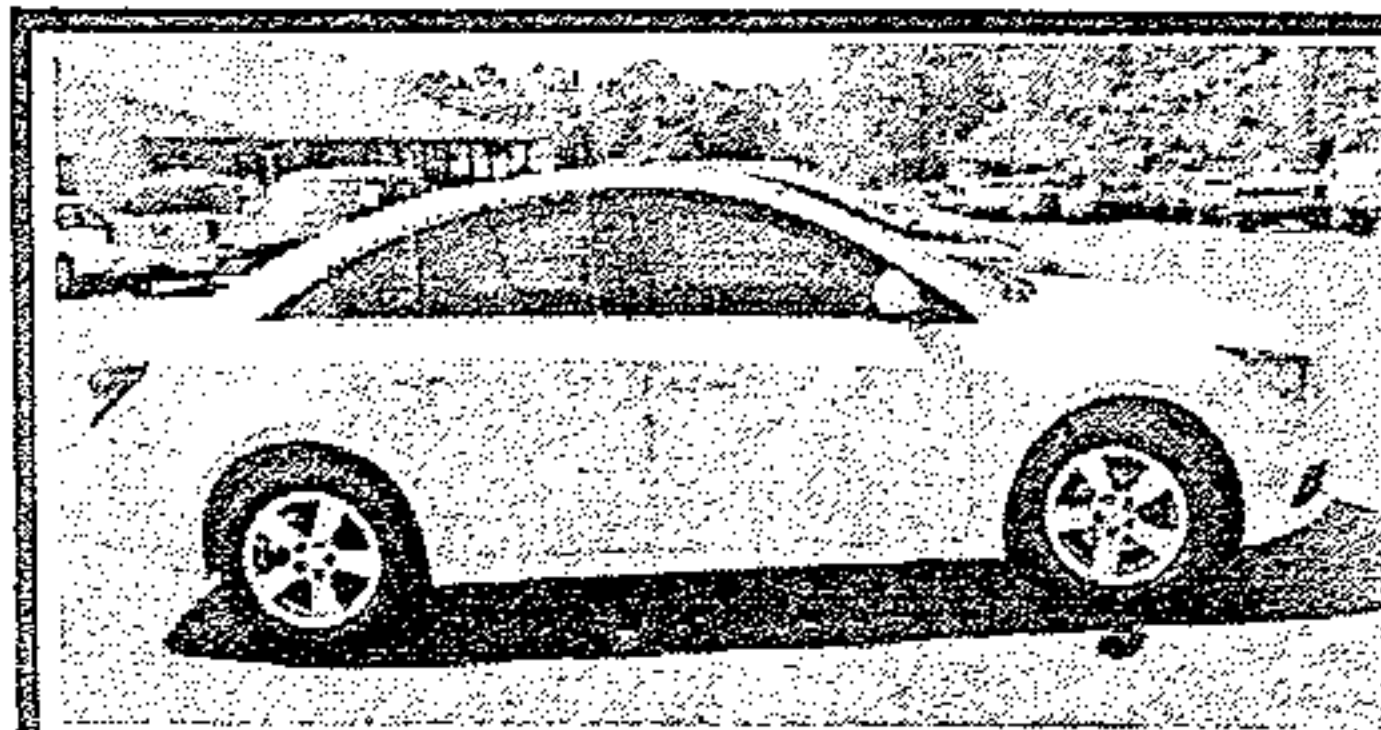

2012 Chevrolet Cruze, Great
Gas Saver, Extra Clean

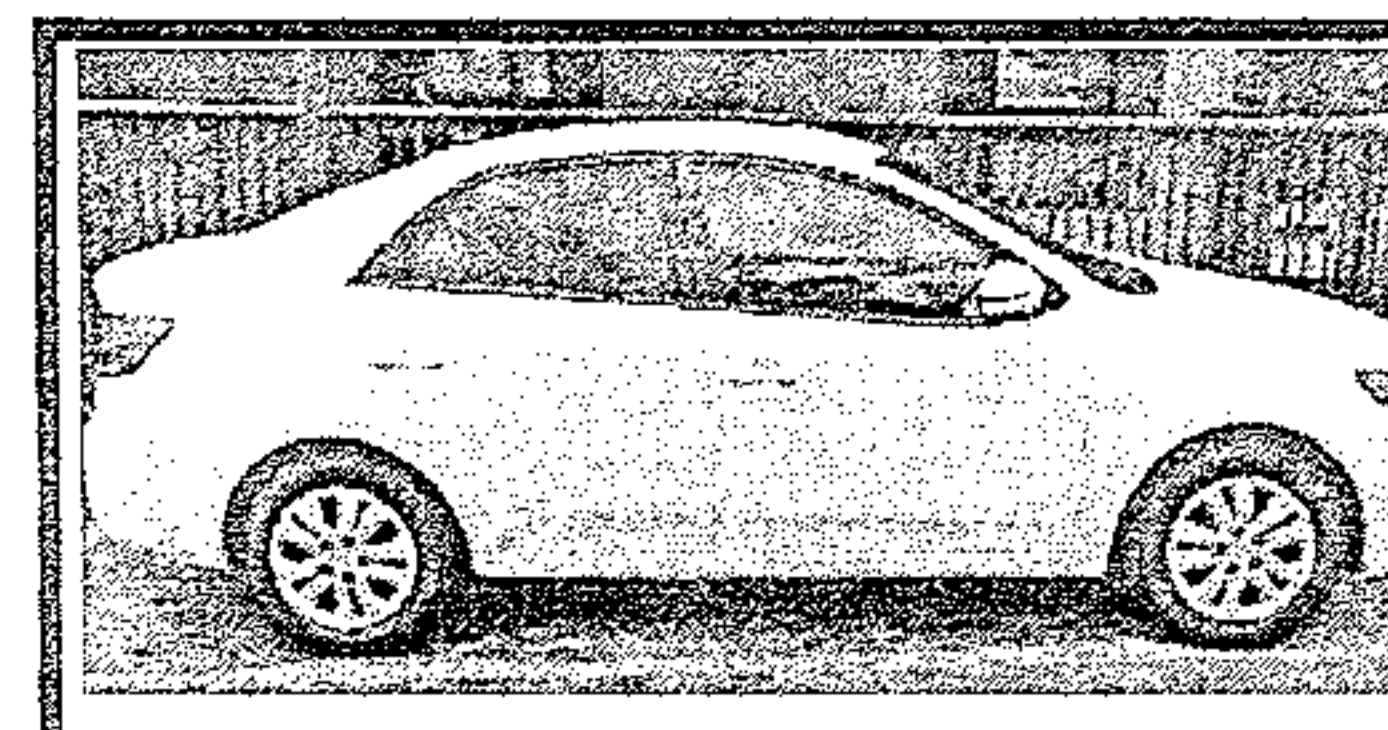

2012 Kia Forte, GAS SAVER,
loaded, Nice Ride

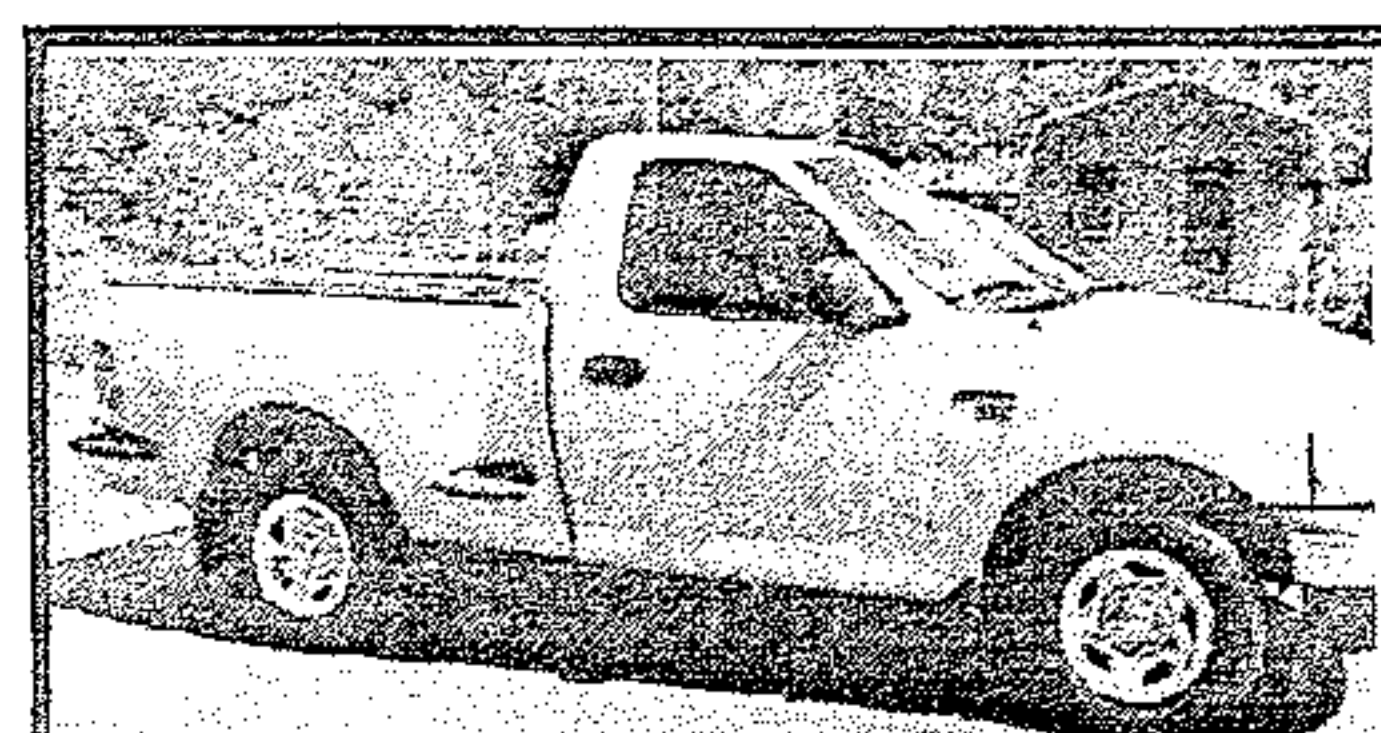

2003 Ford F150 Big Orange
Special! Super Nice Truck!!!



2012 Ford Fusion, Great
MPG, smooth ride

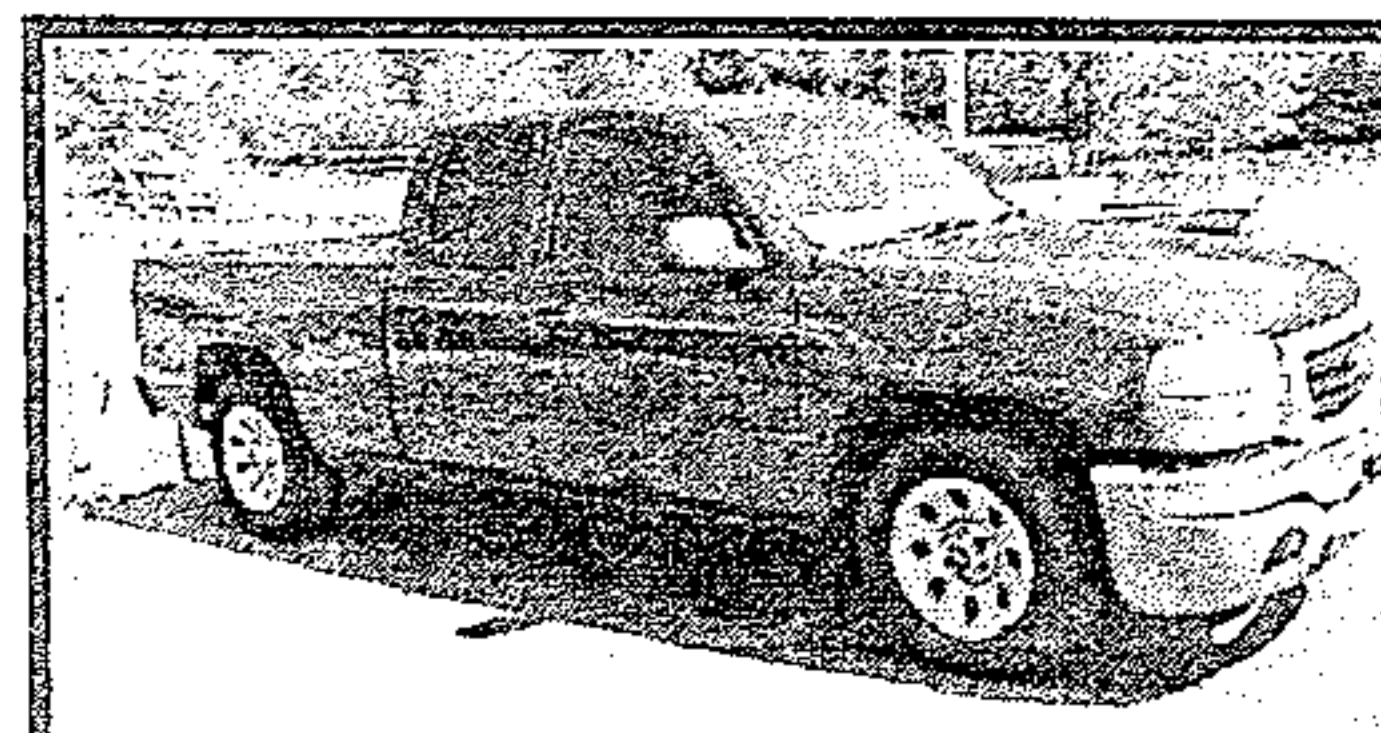

2005 GMC Sierra 1500, XCab,
LWB, Nice Truck

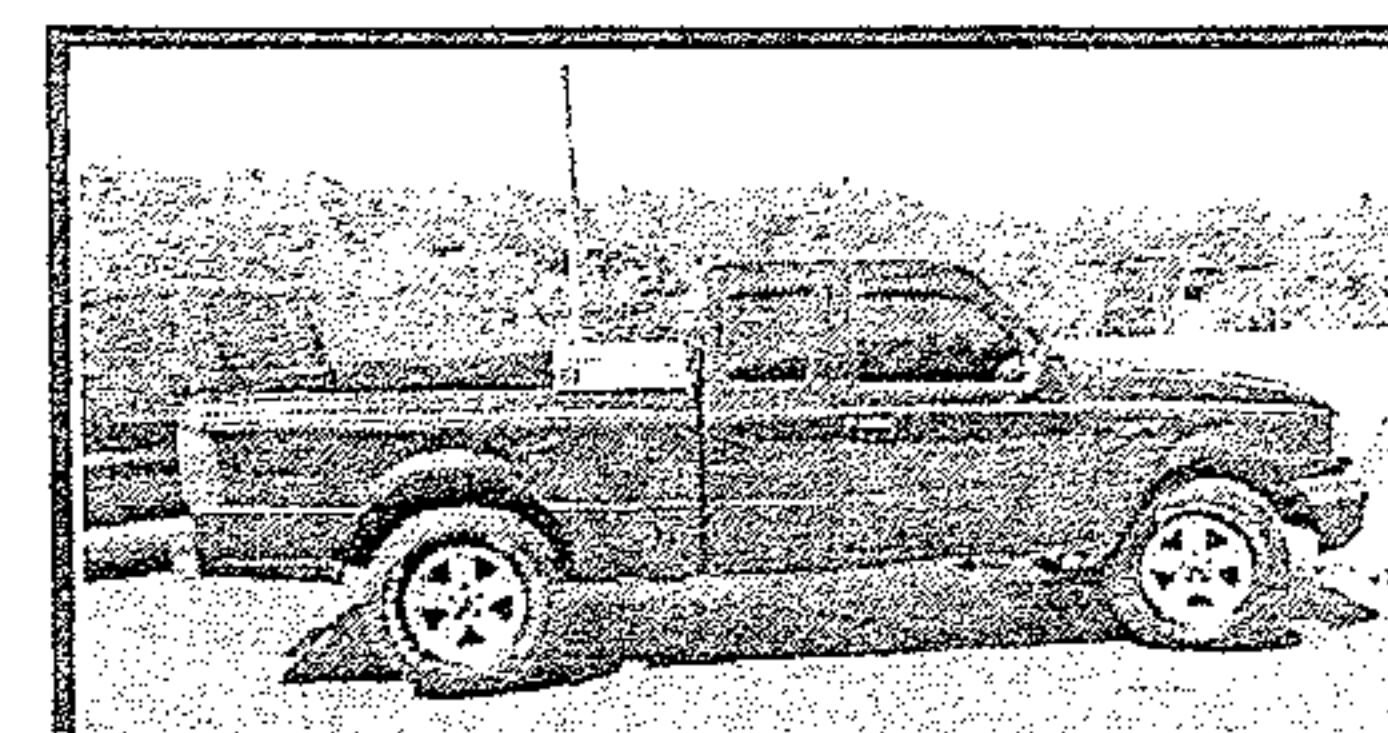

2004 Ford Ranger, Nice Load-
ed, Extra Clean

WALT WILLIAMS, INC.

3003 Highway 11 ^{*with approved credit} Lenoir City, TN **865-986-1111**