

The Daily Edition

50¢

Serving Loudon, Monroe and Surrounding Counties

Wednesday, April 13, 2016

"It's Not Me" doesn't work this time either

Toby Skipper, 37, Spring Street Philadelphia, was charged with DUI, Driving on Revoked/Suspended License, Evading Arrest, and Violation of Implied Consent.

Deputy Kevin Dailley LCSO, radared a white Chevrolet Astro van with a clear audible tone traveling 74 mph in a 50 mph zone on Pond Creek Rd at Galyon Rd. Deputy initiated his emergen-
(see Skipper pg. 2)

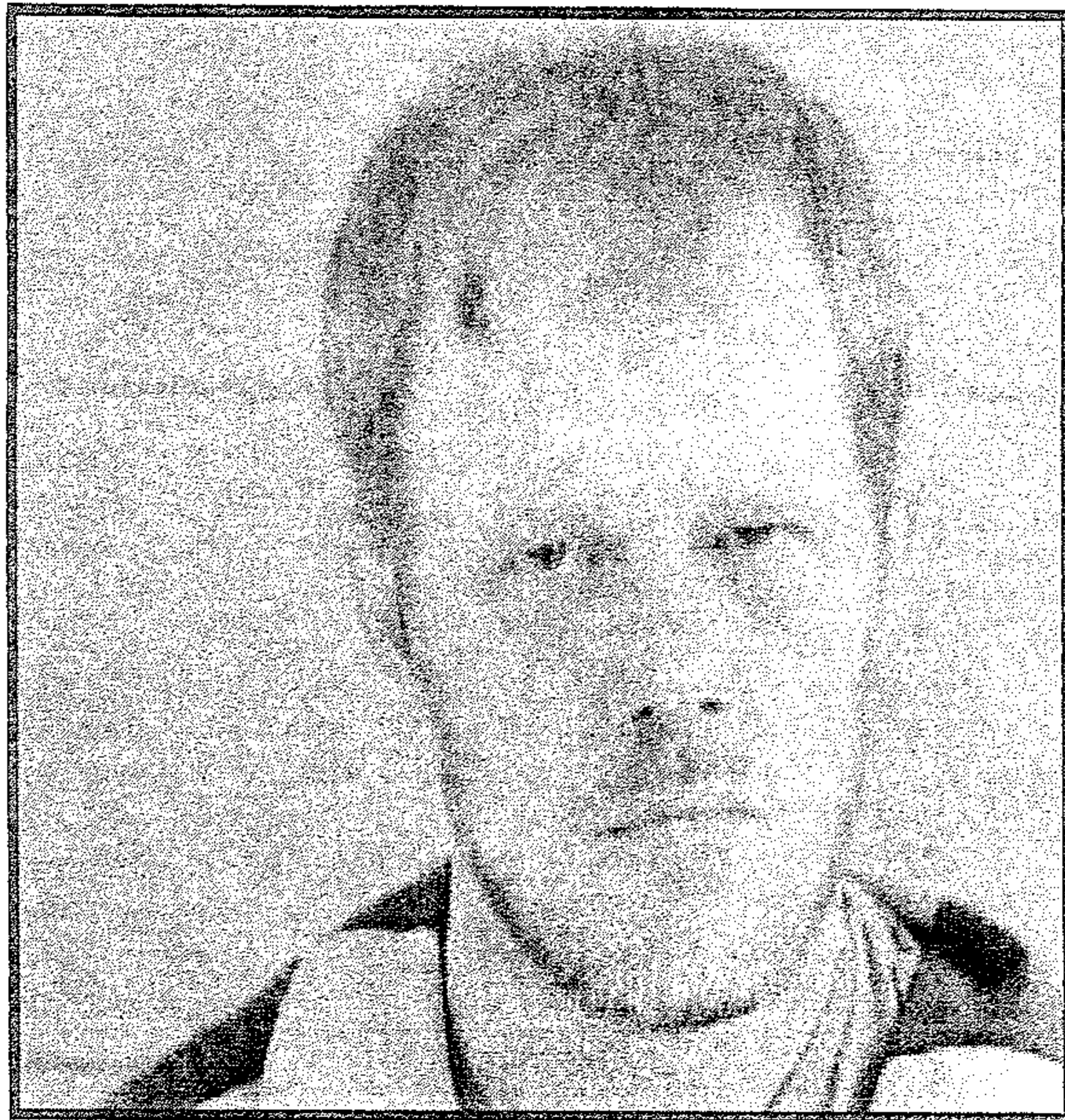

Toby Skipper

Meth, needles, found in LCSO traffic stop



Kimberly Wilkerson

(see meth pg. 5)

2nd DUI after hitting telephone pole



Dusty Martin

(see 2nd DUI pg. 3)

Local Rotary Club offers gem of a publication

To compliment World Rotary Day, which is celebrated February 23, The Rotary Club of Tellico Lake has published a free Provision Tour de Tellico Activity guide.

The four-color publication consists of 40 pages of activities and their location which are available in our area. Included are birding, bicycling, boating, camping, fishing, gardening, golf, hiking, horseback riding, Kayaking, motorcycling, performing arts,

(see rotary pg. 7)

New Top Ten Fugitive

Help Us Find a Murderer

Brenda Delgado, wanted for her role in a murder-for-hire plot that led to the death of a prominent pediatric dentist in Texas, has been named to the FBI's Ten Most Wanted Fugitives list.

A reward of up to \$100,000 is being offered for information leading directly to the arrest of Delgado, who has been described

(see FBI pg. 4)

Verse of the Day

For God did not call us to be impure, but to live a holy life. Therefore, he who rejects this instruction does not reject man but God, who gives you his Holy Spirit. — 1 Thesalonians 4:7-8

Obituaries

see inside **Wazzup**

The Loudon County Grand Jury is meeting this week! Watch for the full report in The Daily Edition soon!!!

Weather

Today: Partly cloudy skies in the morning will give way to cloudy skies during the afternoon. High 72F.
Tonight: Cloudy. Low 48F.
Thursday: Sunshine and clouds mixed. High 72F.
Thursday Night: Partly

cloudy skies during the evening will give way to cloudy skies overnight. Slight chance of a rain shower. Low 48F.

Horoscopes

Aries 3/21-4/19

Thinking about your independence is quali-
(Continued on page 6)



skipper
 cy lights with my sirens as
 Deputy turned around in the
 road, after turning around he
 lost sight of the vehicle how-
 ever came back to find the
 vehicle parked in the middle
 of the road at the second en-
 trance of Galyon Rd up about
 a 1/4 mile within a matter of
 approximately 1 minute. Traf-

fic stop was initiated where
 Deputy came in contact with
 the driver Toby Skipper who
 immediately advised he was
 not driving the vehicle, how-
 ever his female passenger
 stated he was in fact driving
 and was afraid due to him
 being intoxicated. Mr. Skip-
 per stated his licensed was
 revoked, which dispatch later

confirmed as well as the fe-
 male having a valid drivers
 license. Mr. Skipper had the
 smell of an alcoholic bever-
 age on his person as well as
 slurred speech, he stated he

(see skipper ctd. pg. 7)

Call 865-771-2249 to
 Advertise and start
 saving today!
 Has your group got
 an event coming up?
 Let us know!!!

Notice: The Daily Edition does not knowingly accept fraudulent or mislead-
 ing materials. The Daily Edition cannot guarantee the validity of offerings or
 statements contained herein. All liability for the contents of all advertising, and
 for any claims that may arise therefrom, is the responsibility of the advertiser or
 its agency. The Daily Edition reserves the right to reject, edit, or abbreviate any
 advertisement submitted. Advertising is accepted with the understanding that all
 liability for all copyright violations is the sole responsibility of the advertiser.
 Photographs, artwork and other copy submitted for publication is considered
 the sole property of the advertiser. The Daily Edition will make every effort but
 will not be liable for failure to publish and ad or for typographical and layout
 errors. All statements and information about highlights featured items, letters to
 the editor, herein are those solely given to the interviewer or writer and the Daily
 Edition assumes no responsibility of the accuracy or validity thereof. The Daily
 Edition will gladly reprint at no charge that part of an advertisement in which an
 error occurs provided a claim is made within 3 days of the first publication of the
 ad. Information contained in the Wazzup is received anonymously and the Daily
 Edition assumes no responsibility for information and reserves the right to edit
 or reject any and/or all submissions. The Daily Edition is a daily newspaper of
 general circulation in Loudon County defined under TCA 2-1-104(a)(13).
 The Daily Edition also serves Monroe, Knox, Anderson, Roane and Blount coun-
 ties and serves 30,000 readers weekly. Send mail to PO Box 1240, Lenoir City
 TN 37771. 865-771-2249. email: dan1204us@yahoo.com
 The Daily Edition is Loudon County's premier public interest and paid advertising paper. The
 Daily Edition is produced and published daily Monday through Friday and is circulated through-
 out Loudon County and parts of Monroe and Knox Counties. Display advertising rates \$5.00 per
 column inch and quantity discounts available. Call for information on upcoming promotions and
 events.

HACIENDA Ayala's
 Mexican Restaurant
 Market Dr. * Lenoir City (In Front of Food City)

Real Authentic Mexican Food at Affordable Prices

BEST MARGARITA

You've Tried The Rest
 Now Come Have The Best!!!

We Accept ALL Competitors Coupons Outside of Mexico City!

986-3553



Good Credit OK • Bad Credit OK • Bankruptcies OK • Repo OK

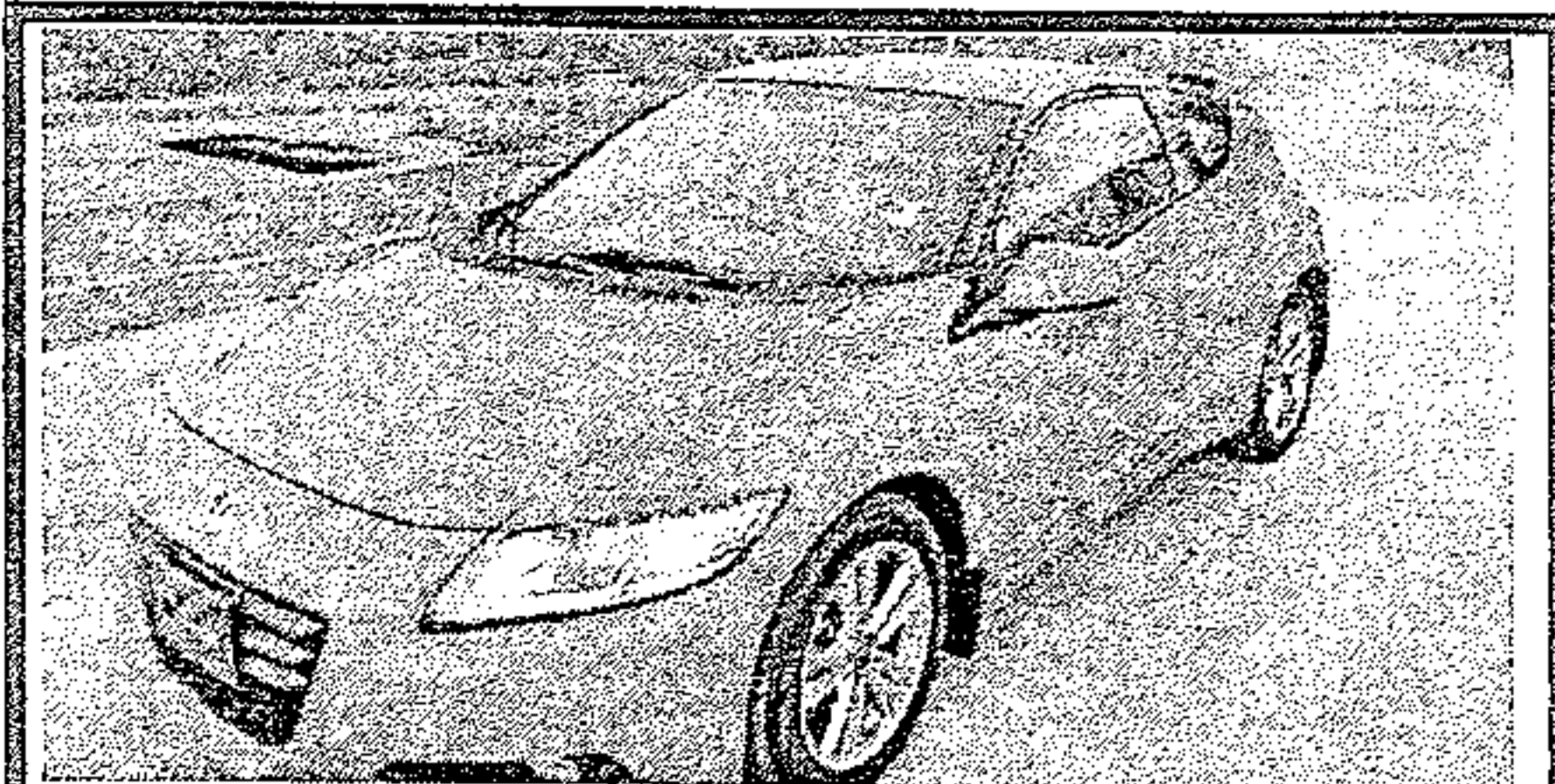

2011 Honda CR-Z Low Miles, Like New, PW, PL, 6 SPD, Hybrid, Gas Saver



2012 Hyundai Sonata Great On Gas, A/C, PW, PL, Tilt Wheel, Keyless Entry, Like New



2007 GMC Canyon 5 spd, Bed Liner, A/C, Heat, Ext Cab



2008 Ford Explorer 84k, 3rd Row Seating, Luggage Rack, Tow Pkg, PW, PL



2011 Ford Ranger Low Miles, Tow Pkg, New Tires, A/C, Heat, Bed Liner.



2011 Dodge Grand Caravan DVD, Stow & Go, Loaded, Remote Doors, Rear A/C

DEPENDABLE MOTORS 986-9343
 803 E. Broadway • Lenoir City

* WAC. See Dealer for details

Visit our website at: www.dependablemotorslc.com

Serving Loudon County for 20 Years

2nd DUI

Dusty Martin, 35, Shaw Ferry Road, was charged with DUI 2nd. Trooper Ryan Smith THp, was dispatched to a single vehicle wreck on Martel Road.

Upon arrival it was noticed that the vehicle had left its lane of travel crossing the center line and struck a telephone pole.

The subject was ejected due to not wearing a seatbelt. The subject was transported to Fort Loudon Medical.

After Trooper worked the wreck and reaching the hospital it was noticed the subject identified as Dusty Martin has an odor of an alcoholic smell about her person, slurred speech, bloodshot eyes, and lethargic actions.

Dusty agreed to a HGN test and displayed six clues of being impaired. Dusty was placed under arrest. Trooper Ryan Smith THP, made the arrest.

For Sale: Oak Wood Mulch

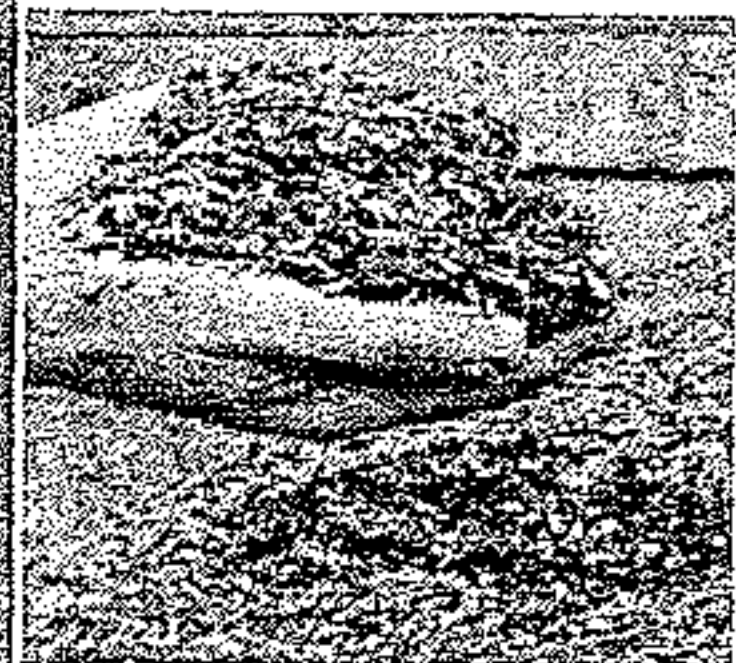

Mushroom Compost Topsoil.



Firewood

Call Steve Spoon
986-4282

C&C Lawn Care
Mowing, Mulching, Trimming, Edging, Clear Debris
Free Estimates
Call Chad 865-271-8070

West End Storage & Warehouses
502 Ward Avenue • Loudon
Call 865-458-4774 or 865-679-5555

C&J Towing and Recovery
LOWEST TOWING RATES AROUND!!!

Have you been overcharged for any type of towing service in the Lenoir City area? If you have a breakdown or accident please OWNER REQUEST C&J Towing with the officer. Also please call your Sheriff and ask him to place C&J Towing on the "Rotation List*" and help other motorists save as much as you did! We at C&J are locally owned and operated, State approved, licensed, bonded and insured. Call and let us know if your denied service or how we can be of assistance.

*note: the "Rotation List" is a list of wrecker services that provide service for wrecks, DUI's, breakdowns, etc. and are on an on-call basis for service. This list is approved by the Sheriff.

Cliff Teeters • Owner
865-809-1661

STAINED INK
TATTOO & PIERCING
LENOIR CITY 865 816-6440
NEW OWNER • NEW ARTIST • SINCE 2011
521 Hwy 321 next to Vape & Stuff & Inn Of Lenoir!
Clean-Affordable-Quality-Custom
Tattoo's You've Always Wanted!

BRING IN THIS AD FOR **\$25 OFF**
NEW INK FOR NEW CUSTOMERS ONLY!

Check us out on FB.com/
Stained.Ink.Tattoo/
www.STAINEDINK.com

BIMBO'S
Deli Open 24 Hours
865-986-9643 Call Ins Welcome
Specials
Lg. Cold Sub, bag of chips and 16 oz. fountain drink
only \$6.29
Footlong Corn Dog \$2.59

FBI
as a master manipulator and may be on the run in Mexico.

On September 2, 2015, Dr. Kendra Hatcher was murdered in the parking garage of her Dallas apartment complex. Delgado, who was studying to be a dental hygienist, is suspected of hiring two co-conspirators to carry out the murder. "Apparently she was jealous because the victim was dating her ex-boyfriend," said Special Agent Jason Ibrahim, a member of the FBI's Dallas Violent Crimes Task

Force.
"Brenda Delgado was able to effectively manipulate everyone she involved in her calculated scheme," said Thomas M. Class, Sr., special agent in charge of the FBI's Dallas Division. "Although she didn't pull the trigger herself, she is still responsible for the murder," Class added, "and through international publicity and a significant reward offering, we intend to find her and to bring her to justice."

A Mexican citizen, Delgado is believed to have fled the country shortly after being

interviewed by investigators about the killing. She has been charged with capital murder, and a federal fugitive warrant has been in place since October 2015. Both co-conspirators have been arrested and are in custody.

Born Brenda Berenice Delgado Reynaga, the 33-year-old fugitive is described as a Hispanic female, 5 feet 5 inches tall, weighing approximately 145

pounds, with brown eyes and black hair that may be dyed a lighter color. She has a butterfly tattoo on the small of her back. Delgado has ties to Mexico, and investigators strongly believe she may be residing there. She should be considered armed and dangerous.

The search for Delgado is being coordinated by the Dallas Violent Crimes Task Force, which consists of FBI personnel and

detectives from the Dallas and Garland Police Departments. Lee Thompson, a Dallas Police Department detective and member of the task force, explained that the unusual circumstances behind Hatcher's murder have drawn publicity to the case from around the world.

Delgado told one of her co-conspirators that she was connected with a cartel and could provide him with a steady source of drugs if he carried out the murder. "He thought he had an in with the cartel," Thompson said.

In the days leading up to the murder, it is believed Delgado learned that her ex-boyfriend and Hatcher were planning a vacation to Cancun and that he had introduced

(see FBI ctd. pg. 5)

PUBLIC NOTICE

Lenoir City Budget Committee Meetings

The Lenoir City Budget Committee will hold meetings at City Hall, in the small conference room, on the following dates and times:

- Monday, April 18, 2016 at 10:00 A.M.
- Thursday, April 21, 2016 at 10:00 A.M.
- Monday, April 25, 2016 at 10:00 A.M.

The purpose of the meetings will be to continue discussion and preparation of the 2016-2017 Fiscal Year Budget.

The public is encouraged to attend.
Thank you.

good to know you™

IMMEDIATE OPENINGS!

Randstad is NOW HIRING for 1st shift Assembly Positions at Commercial Vehicle Group. These are long-term, temp-to-hire positions!

Hours: 6am - 4:30pm (end times vary)
Pay: \$9.50/\$10 per hour

You may apply by visiting our Facebook page www.facebook.com/vonorejob and clicking the "Sign Up" button. You can also get a paper application from the Guard Shack at 200 National Drive, Vonore, TN 37885.

For questions, call 423/884-4733

www.randstadstaffing.com

EOE

randstad

Staffing | Professional | Search & Placement | HR Solutions | In-house Services

**Kelley's
Tree
Service**
Free Estimates
Fully Insured
865-414-3014

BUDGET
Transmissions

302 S. Northshore Drive Knoxville

(865) 584-4391 budget-transmissions.com

Why Buy From Budget?

Free Towing From Lenoir City or Loudon County
20 Years of BBB Zero Customer Complaints Award Member
A+ Plus Rated

Huge Transmission Inventory
Best Technicians Period!!!

Call (865) 584-4391 Today!



NEED HELP WITH INCOME TAX? PROFESSIONAL TAX SERVICE

PRICE - 95% of returns between \$60-\$140

(No Coupons Required)

LOCALLY owned & Operated - Open Year Round

30+ Years in the business

ALL Preparers with 10+ years experience

Pro Tax

111 E. Broadway

Lenoir City, TN 37771

Phone 865-986-4035

*US Armed Service Active Duty Personnel, "THANK YOU", Tax Return Free

meth

Kimberly Wilkerson, 39, West 2nd Ave Lenoir City, was charged with Poss. SCH. II, and Poss. of Drug Para. Deputy Jeremy Garland LCSO, traffic stopped a white ranger on Muddy Creek at Virtue Road for having expired tags. Contact was made with the driver

Kimberly Wilkerson, whom seemed to be very nervous and restless and was speaking very fast. Upon further investigation Kimberly was ask if there was anything illegal in the vehicle or on her person. Kimberly stated that a friend might have left something in the vehicle. Kimberly did consent to a search of the vehicle. Under

the driver seat Deputy located a silver glass case containing a syringe, straw, spoon, and several small baggies that contained a white powdery substance. The white powder tested positive for meth. Kimberly was placed under arrest. Deputy Jeremy Garland LCSO, made the arrest.

FBI ctd. from pg. 4

Hatcher to his parents. Delgado is the ninth woman to be placed on the FBI's Ten Most Wanted Fugitives list. Since its creation in 1950, 474 of the 506 fugitives named to the list have been apprehended or located—156 of them as a result of citizen cooperation.

We need your help: Investigators urge anyone with information concerning Del-

gado to take no action themselves. Instead, they should contact the FBI by calling 1-800-CALL-FBI or submitting a tip online. The FBI's Dallas Field Office can be reached at 972-559-5000. For possible sightings outside the United States, contact the nearest U.S. Embassy or Consulate.

Haslam Announces 81 Percent Retention Rate for Promise Students

Retention numbers indicate early success for first class of Tennessee Promise students

Tennessee Gov. Bill Haslam today announced 81 percent of the 2015-16 class of Tennessee Promise students returned for the spring semester after beginning classes last fall.

This high retention rate for Tennessee Promise students is a significant indicator they are on pathways to success in higher education.

"When we launched Tennessee Promise, our goal was not only to get more students to enroll in a technical or community college but also to see the students succeed and graduate," Haslam said. "Students must receive post-secondary credentials if we're going to achieve the goal of Drive to 55, and we will continue to work with our campus leaders to ensure these students have the highest possible chances of attaining their certificate or degree."

In fall 2015 there was a 24.7 percent enrollment increase at community colleges and a 20 percent enrollment increase at colleges of applied technology (TCATs).

Data provided by the Tennessee Higher Education Commission in-

(see Haslam ctd., pg. 7)

PURDY'S AUTO PARTS AND SALVAGE

WE BUY SCRAP IRON • COPPER • BRASS • ALUMINUM

\$

Paying Top \$\$\$
Call For Latest Prices

You Name It, We Buy It!

Radiators, Wheels, Batteries, Appliances, Farm Equipment

Copper
Paying Top \$\$\$
Call For Latest Prices

Complete Cars
per 100 lbs.

Scrap Metal
Paying Top \$\$\$
Call For Latest Prices
per 100 lb

We Buy Batteries

Aluminum Cans
Paying Top \$\$\$
Call For Latest Prices

You Call We Haul!
423-519-5402



Now Selling Aftermarket Body Parts at Discount Prices

Prices subject to change with the market.

423 337-3977
149 County Road 323 Sweetwater

Prices subject to change with the market.

skipper ctd. from pg. 2
 had not consumed any alcohol and agreed to perform field sobriety where he performed poorly. The female consented to write a statement advising Mr. Skipper was the driver, Mr. Skipper who had fell asleep in the back seat did refuse implied consent as well. The vehicle was towed by Biven's Wrecker Service after he refused to let the female drive the vehicle. He was transported to the Loudon County Justice Center without incident on multiple charges. Deputy Kevin Dailey LCSO, made the arrest.

Rotary
 pickleball, rafting and tubing, railroading, sports venues, tennis and zip-lining.
 According to John Everson, President of the Rotary Club of Tellico Lake, "the Activity Guide fulfills a need for a single publication that basically answers the question -- 'I'm new to the area, or have visitors arriving and I'm looking for things to do.' Our membership contacted both the Loudon and Monroe Chambers of Commerce and discovered individual pamphlets were available on some activities, but not all and certainly not in a single guide book. Our mission was to provide information

on fun day trips, so we canvased the area beyond our local communities, and sought unique experiences from Tellico Lake through the Foothills and into the great Smoky Mountains."
 The intent is to publish the Activity Guide yearly and to keep adding to fun adventures. Our goal is to make this a handy reference guide that can be used time and again throughout the year.
 A copy of the Activity Guide is available from numerous businesses in Monroe and Loudon counties or in the lobby of the Rarity Bay Clubhouse, Tellico Village Clubhouses, Ijams Nature Center, Outdoor Knoxville,

Knoxville Visitors Center, Loudon Visitors Center, and Provision Proton Therapy Center in Knoxville.
 The Rotary Club of Tellico Lake meets every Thursday at noon in the Rarity Bay Clubhouse. The public is welcome to attend and enjoy the speaker series as well as learn more about the Club's involvement in charities abroad and in East Tennessee.
 Haslam ctd. from pg. 5
 dicates that Tennessee Promise students enrolled at a TCAT had a retention rate of almost 95 percent while community college students were retained at a rate of 78.5 percent. The community college data also includes Austin Peay State University,

the single public university with associate degree students.
 The retention rates for Tennessee Promise students by college are:
 Austin Peay 88.7%
 Chattanooga State 78.4%
 Cleveland State 74.5%
 Columbia State 74.9%
 Dyersburg State 81.1%
 Jackson State 81.9%
 Motlow State 84.8%
 Nashville State 81.2%
 Northeast State 77.1%
 Pellissippi State 77.2%
 Roane State 72.1%
 Southwest 84.8%
 Volunteer State 73.4%
 Walters State 75.5%
 All 27 TCATS 94.7%
 Total Average 80.6%
 DRIVE TO 55: In 2013, Governor Haslam launched the Drive to 55 to increase the number of Tennesseans with a postsecondary degree or certificate to 55 percent by 2025. As a re-see FBI conc. pg. 8

LOOK!
\$75 Weekly Payments
LOOK!

MARTY'S AUTO SALES • 986-2222
MARTY'S AUTO SALES • 986-2222
MARTY'S AUTO SALES • 986-2222
MARTY'S AUTO SALES • 986-2222
MARTY'S AUTO SALES • 986-2222

Bad Credit
 Divorce
 Fixed Income
 Repos
 Bankruptcy
 No Credit

APPROVED!

Visit Us On The Web At:
martyautosales.net

NO
 CREDIT
 CHECKS

\$799
down*

04 Envoy, 3rd row, Runs Great Only \$799 down *

\$99
down*

97 Astro, 7 passenger, Runs Great, Only \$99 down *

\$299
down*

99 Century, auto, 4 dr, Clean, Only \$299 down *

\$799
down*

05 XL7, auto, 4x4, NICE!!! Only \$799 down *

\$599
down*

05 Trailblazer, auto, good miles Only \$599 down *

\$99
down*

98 Malibu, auto, runs good, Only \$99 down *

\$199
down*

95 Frontier, 5spd, Cold AC, Runs Good Only \$199 down

\$99
down*

98 Bonneville, 6 cyl, Auto, low payments only \$99 down *

NO
Credit Checks

Marty's Auto Sales

986-2222

Se Habla Español

100%
Approval*

*See Dealer for details. All down payments plus tax, tag, title and fees.

MARTY'S AUTO SALES • 986-2222
MARTY'S AUTO SALES • 986-2222
MARTY'S AUTO SALES • 986-2222
MARTY'S AUTO SALES • 986-2222
MARTY'S AUTO SALES • 986-2222

FBI ctd. from pg. 7

sult, the Drive to 55 has established the Tennessee Promise program, the nation's first scholarship and mentorship program that provides high school graduates last-dollar scholarships to attend two years of community or technical college free of tuition and fees; reduced the number of college freshmen requiring remediation through the SAILS (Seamless Alignment and Integrated Learning Sup-

port) program; provided free technical college for adults through TCAT Reconnect Grants; created Tennessee Reconnect + Complete to help more adults return to college to complete unfinished degrees; developed a more comprehensive state approach to serving student veterans; and leveraged technology to enhance classroom instruction and college advising.

- See more at: <https://www.tn.gov/news/39429#sthash.b1eigkAq.dpuf>

LONNIE JONES OPTICAL DISPENSARY

"We Make The Difference You Can See"
Locally Owned and Operated

Over 1000 Frames To Choose From
No Frame Over \$69.00



On the corner of A & Depot Street, Lenoir City

986-7803

Serving Loudon County for over 40 years

A Name You Already Know And Trust Just Got Even More Dependable
DEPENDABLE AUTO SERVICE, LUBE AND TIRES
is Now Offering
Expert, Affordable Transmission Service
All ASE Certified Technicians

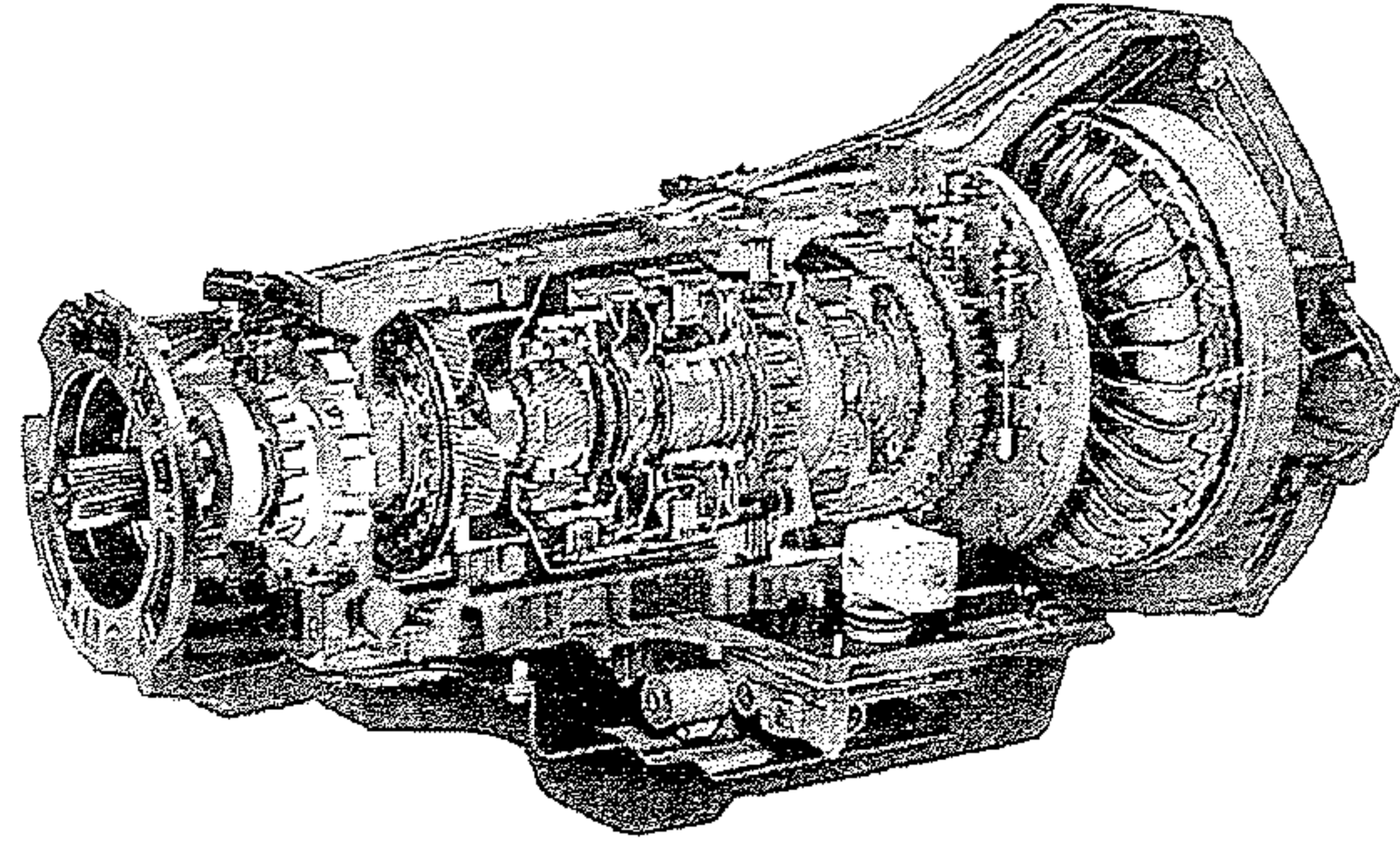

We proudly welcome all New Customers and Former Advanced Transmission Customers with a 10% Discount and Any Transmission Service or Repair*

865-986-9359

865-986-5050

Bad Credit, No Credit OK!!! We Finance Everybody!!! Low Down Payment!!! We Are The Bank!!!

Over 100 Cars, Trucks & Vans in Stock - Warranties On ALL Vehicles Sold!!!



2007 Chevrolet Uplander, 60k miles, NICE!!!

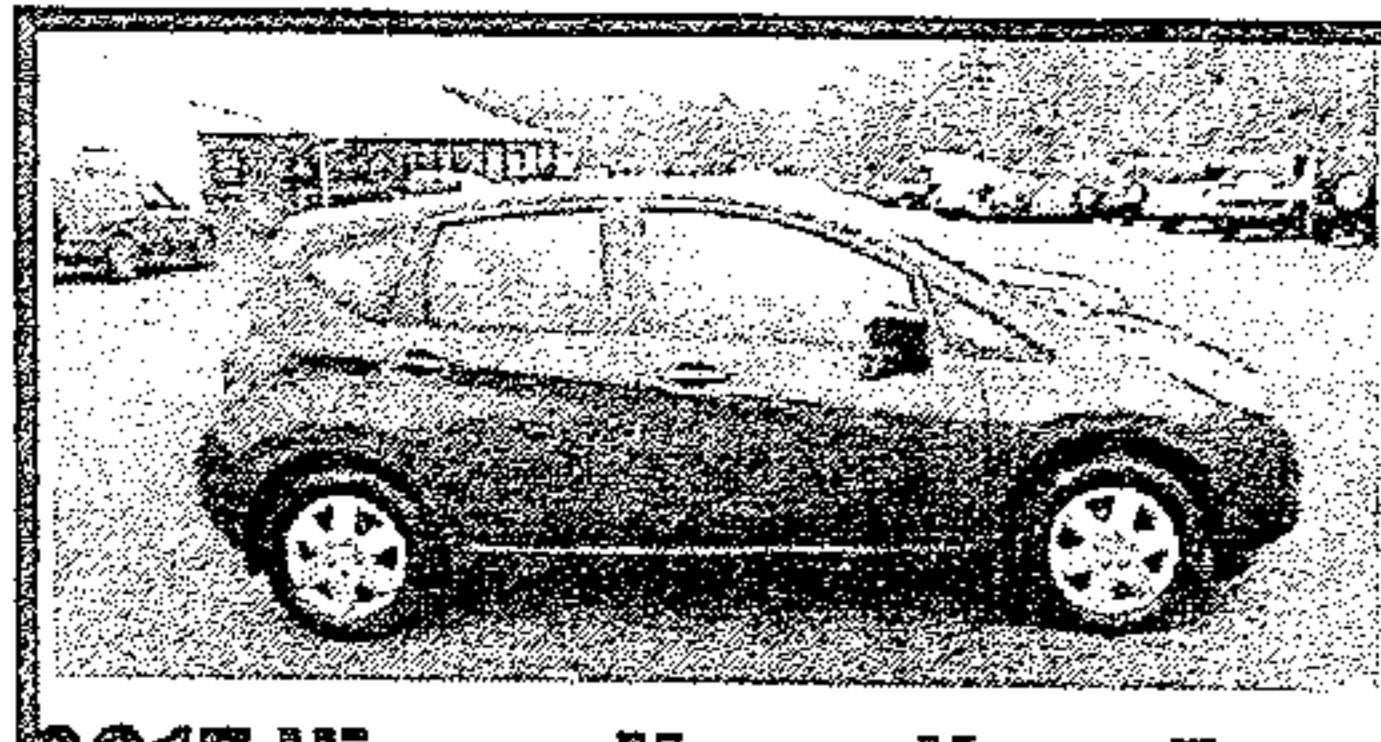

2015 Nissan Versa Note, Factory Warranty, Low Miles

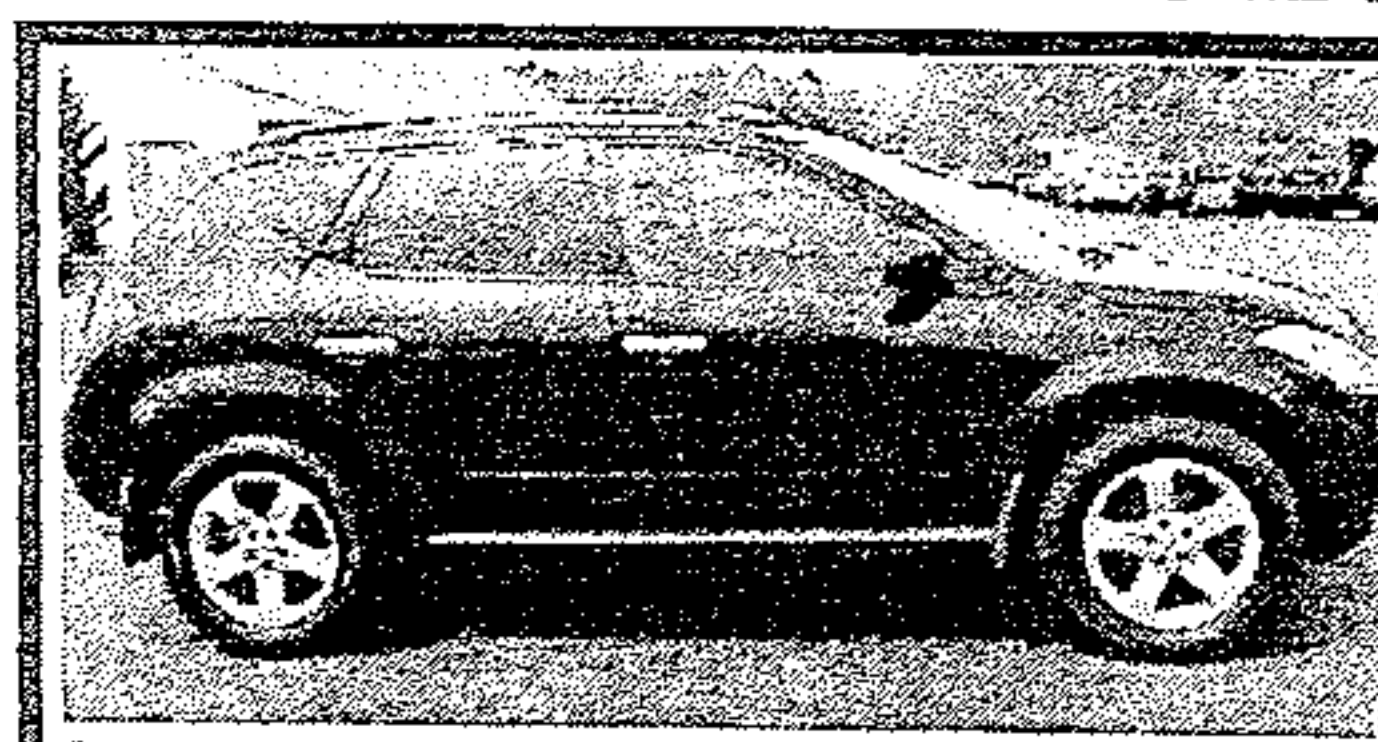

2004 Nissan Murano, Nice, LOADED!!!



2008 Saturn VUE, LOADED!!! 4dr, Ready to go on a trip!



2002 Ford Ranger, Extra Cab, 79k miles

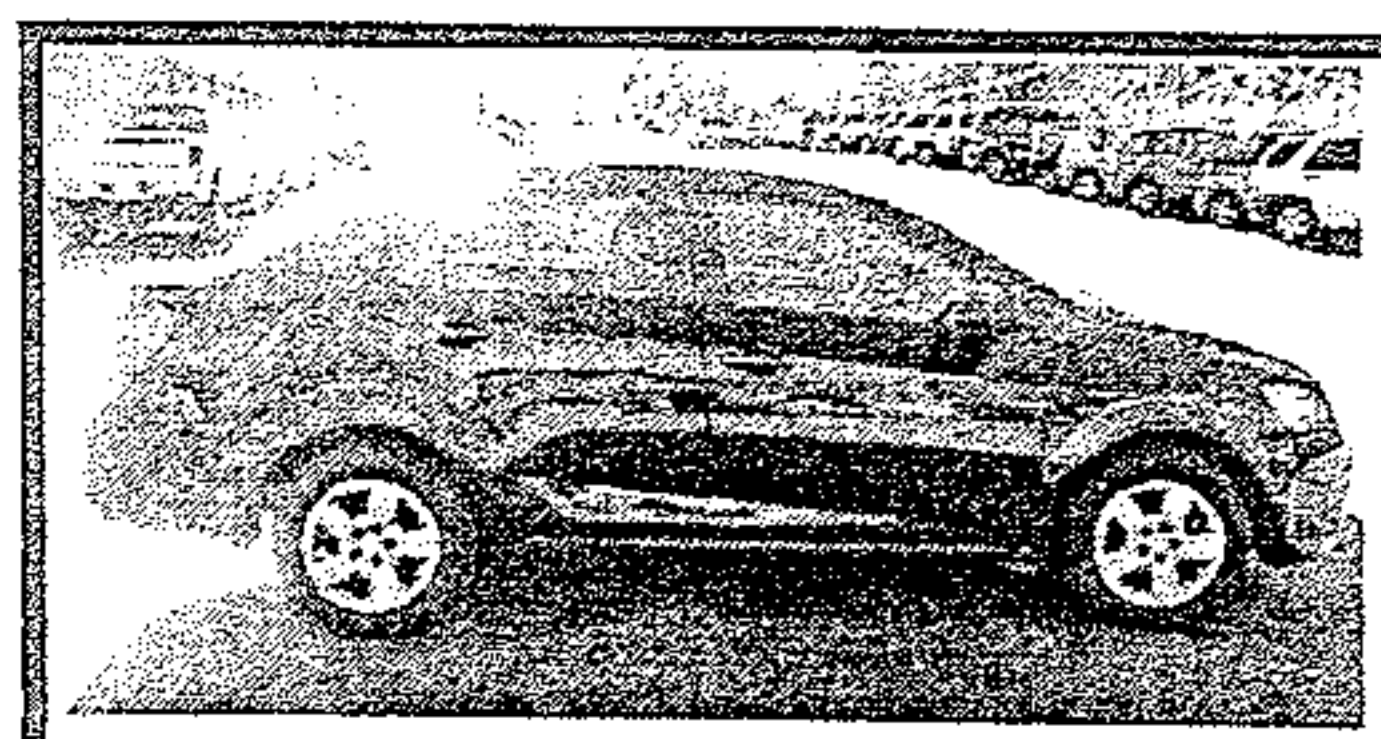

2014 Chevy Sonic, Factory Warranty, Low Miles!



2004 Dodge Ram 1500, 4 door, 41k miles



2003 Dodge Dakota, Custom Truck, Sharp!!! V8

WALT WILLIAMS, INC.

*with approved credit

3003 Highway 11

Lenoir City, TN

865-986-1111