

The Daily Edition

50¢

Serving Loudon, Monroe and Surrounding Counties

Wednesday, March 9, 2016

Craigslist thief nabbed after trying to sell stolen bike to Detective in Loudon



Michael Giles

(see thief pg. 2)

Jackson County Employees Not on Pension Plan

The Tennessee Comptroller's annual audit of Jackson County government found that 18 county employees and one Highway Department employee were not participating in the Tennessee Consolidated Retirement System (TCRS) pension plan. State law mandates participation by all eligible employees.

Comptroller auditors were unable to determine if Jackson County's pension liability was recorded correctly. This resulted in a finding of material noncompliance and qualified opinions on the county's financial statements.

(see pension pg. 7)

GOODSHEPHERD CENTER DINNER AND AUCTION

The Good Shepherd Center of Monroe County will hold its annual fund raising Dinner and Auction on April 2, 2016.

The location will be at the Tellico West Conference Center, 121 Grand Vista, Vonore TN 37885.

The silent auction will begin at 5:30 PM and the catered dinner will be at 6:30 PM.

(see GS pg. 5)

No seatbelt ends with LCSO charges



William Mashaw (see LCSO pg. 5)

Eddie Mannis selected to receive the FBI Director's Community Leadership Award



(see award pg. 3)

Verse of the Day

From the LORD comes deliverance. May your blessing be on your people.

— Psalm 3:8

Obituaries

see inside

Wazzup

Happy Birthday to the Shark Man! Hope it was a great one!

Weather

Today: Sunshine and clouds mixed. High 77F.

Tonight: Partly cloudy skies. Low 53F.

Thursday: Mainly cloudy. High 77F.

Thursday Night Cloudy in the evening, then off and on rain showers after midnight. Thunder pos-

sible. Low 58F.

Horoscopes

Pisces 2/19-3/20

Inspirational people share their brilliant ideas with you today, enticing you to join them on their journeys. The Sun in your dreamy sign opposes

(Continued on page 6)



thief

Michael Giles, 25, Carmel Lane Loudon, was charged with Theft of Property. Officer Sgt. Bill Evans, and Marty Ward LPD, answered a call in reference to a stolen motorcycle located on Carding Machine Road. The cycle in question was a Suzuki. The person making the call was a

Detective from Greenville Tn., Police Dept. Detective had came to Loudon to meet with an individual to discuss purchasing this motorcycle which he had found advertised on Craiglist. The Detective meet with Michael Giles, the detective became suspicious about the story Michael was telling him. The detec-

(see thief ctd. pg. 4)

Call 865-771-2249 to Advertise and start saving today!
Has your group got an event coming up?
Let us know!!!

To Get a Burning Permit:
 Loudon (865) 986-8395
 Monroe (423) 442-7401
 Roane (865) 354-1054

Notice: The Daily Edition does not knowingly accept fraudulent or misleading materials. The Daily Edition cannot guarantee the validity of offerings or statements contained herein. All liability for the contents of all advertising, and for any claims that may arise therefrom, is the responsibility of the advertiser or its agency. The Daily Edition reserves the right to reject, edit, or abbreviate any advertisement submitted. Advertising is accepted with the understanding that all liability for all copyright violations is the sole responsibility of the advertiser.

Photographs, artwork and other copy submitted for publication is considered the sole property of the advertiser. The Daily Edition will make every effort but will not be liable for failure to publish and ad or for typographical and layout errors. All statements and information about highlights featured items, letters to the editor, herein are those solely given to the interviewer or writer and the Daily Edition assumes no responsibility of the accuracy or validity thereof. The Daily Edition will gladly reprint at no charge that part of an advertisement in which an error occurs provided a claim is made within 3 days of the first publication of the ad. Information contained in the Wazzup is received anonymously and the Daily Edition assumes no responsibility for information and reserves the right to edit or reject any and/or all submissions. The Daily Edition is a daily newspaper of general circulation in Loudon County defined under TCA 2-1-104(a)(13).

The Daily Edition also serves Monroe, Knox, Anderson, Roane and Blount counties and serves 30,000 readers weekly. Send mail to PO Box 1240, Lenoir City TN 37771. 865-771-2249. email: dan1204us@yahoo.com

The Daily Edition is Loudon County's premier public interest and paid advertising paper. The Daily Edition is produced and published daily Monday through Friday and is circulated throughout Loudon County and parts of Monroe and Knox Counties. Display advertising rates \$5.00 per column inch and quantity discounts available. Call for information on upcoming promotions and events.

HACIENDA Ayala's
Mexican Restaurant
 Market Dr. * Lenoir City (In Front of Food City)

Real Authentic Mexican Food at Affordable Prices

BEST MARGARITA

You've Tried The Rest Now Come Have The Best!!!

We Accept ALL Competitors Coupons Outside of Mexico City!

986-3553



Good Credit OK • Bad Credit OK • Bankruptcies OK • Repo OK



2010 Kia Soul Sporty, 4 cyl, Auto, PW, PL, A/C, Great On Gas, Like New



2010 Ford Escape Limited Leather, Alloy Wheels, Heat, A/C, Luggage Rack, 79K,

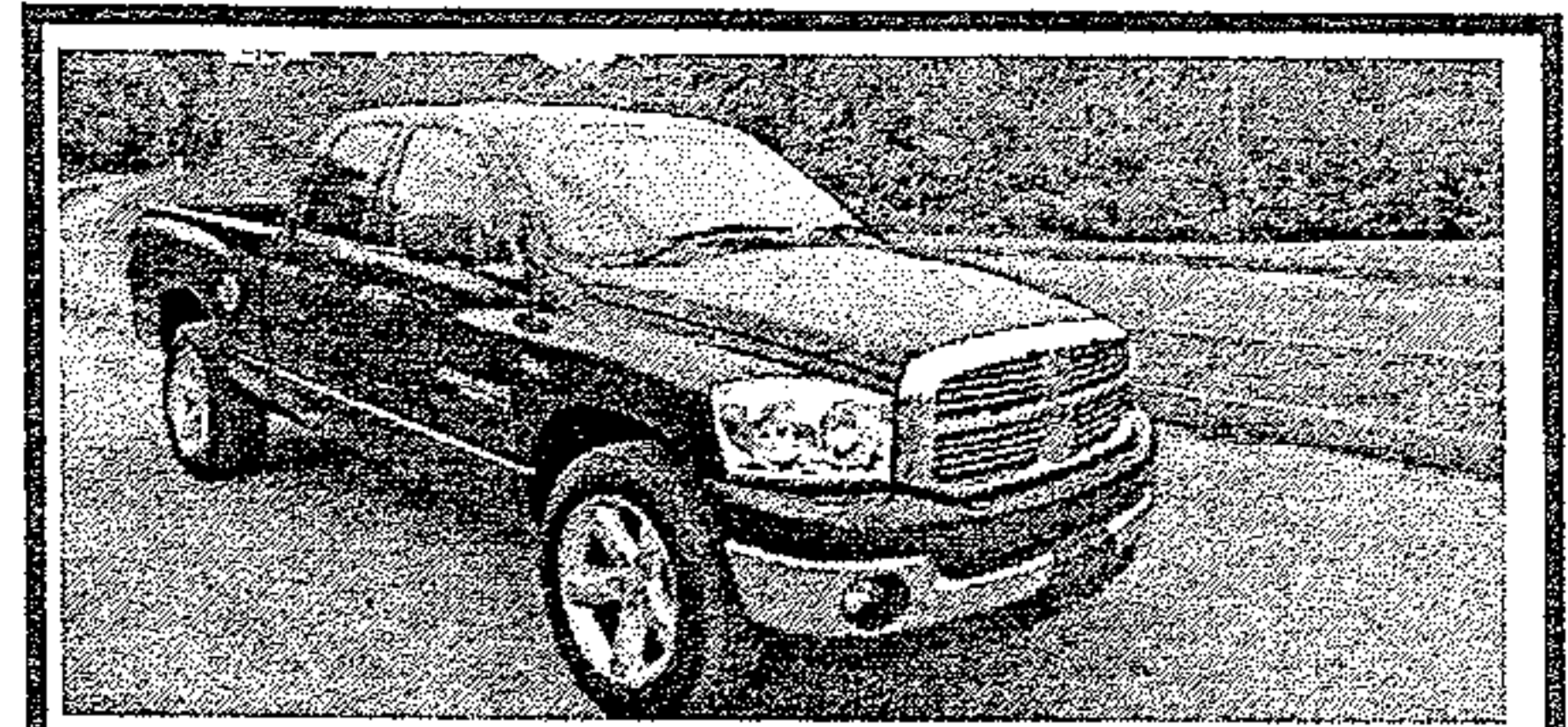

2007 Dodge Ram 1500 Quad Cab, Thunder Road PKG, 20 in. Wheels, Low Miles, Hemi



2008 Ford Explorer 84k, 3rd Row Seating, Luggage Rack, Tow Pkg, PW, PL



2011 Ford Ranger Low Miles, Tow Pkg, New Tires, A/C, Heat, Bed Liner.



2011 Dodge Grand Caravan DVD, Stow & Go, Loaded, Remote Doors, Rear A/C

DEPENDABLE MOTORS 986-9343
803 E. Broadway • Lenoir City

* WAC. See Dealer for details

Visit our website at: www.dependablemotorslc.com

Serving Loudon County for 20 Years

award

Federal Bureau of Investigation (FBI) Special Agent in Charge Edward W. Reinhold, Knoxville Division, presented Eddie Mannis with the 2015 FBI Director's Community Leadership Award

on March 7, 2016 at the FBI Field Office in Knoxville, Tennessee.

Since 1990, the FBI Director's Community Leadership Award (DCLA) has been a principal means by which the FBI has publicly recognized the achievements of individuals and organizations that make extraordinary contributions to their communities. Eddie Mannis was selected for his outstanding contribution to his community for establishing the HonorAir Knoxville Program.

Mr. Mannis is President of Prestige Cleaners and Tuxedo. As a business owner he believes that successful companies should give back to the communities in which they have been successful. Mannis supports many community organizations, but no

(see award ctd. pg. 5)

For Sale: Oak Wood Mulch

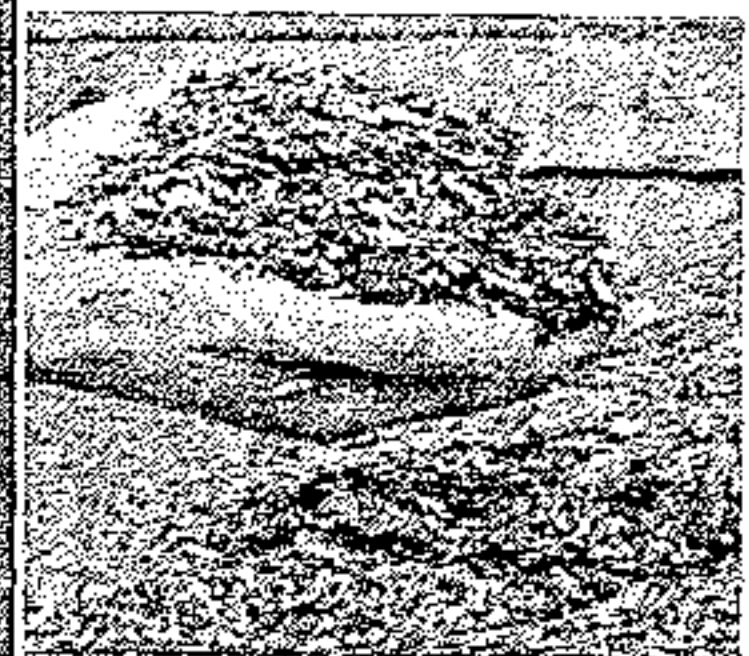

Mushroom Compost Topsoil.



Firewood

Call Steve Spoon
986-4282

The Daily Edition
serving Loudon and surrounding counties since 1986

C&C Lawn Care
Mowing, Mulching, Trimming, Edging, Clear Debris
Free Estimates
Call Chad 865-271-8070

West End Storage & Warehouses
502 Ward Avenue • Loudon
Call 865-458-4774 or 865-679-5555



STAINED INK
TATTOO & PIERCING
LENOIR CITY 865 816-6440
NEW OWNER • NEW ARTIST • SINCE 2011
521 Hwy 321 next to Vape & Stuff & Inn Of Lenoir!
Clean-Affordable-Quality-Custom
Tattoo's You've Always Wanted!

BRING IN THIS AD FOR **\$25 OFF**
NEW INK FOR NEW CUSTOMERS ONLY!

Check us out on FB.com/
Stained.Ink.Tattoo/
www.STAINEDINK.com



BIMBO'S
Deli Open 24 Hours
865-986-9643 Call Ins Welcome
Specials
Lg. Gold Sub, bag of chips and 16 oz. fountain drink only \$6.29
Footlong Corn Dog \$2.59

C&J Towing and Recovery
LOWEST TOWING RATES AROUND!!!

Have you been overcharged for any type of towing service in the Lenoir City area? If you have a breakdown or accident please OWNER REQUEST C&J Towing with the officer. Also please call your Sheriff and ask him to place C&J Towing on the "Rotation List*" and help other motorists save as much as you did! We at C&J are locally owned and operated, State approved, licensed, bonded and insured. Call and let us know if your denied service or how we can be of assistance.

*note: the "Rotation List" is a list of wrecker services that provide service for wrecks, DUI's, breakdowns, etc. and are on an on-call basis for service. This list is approved by the Sheriff.

Cliff Teeters • Owner
865-809-1661

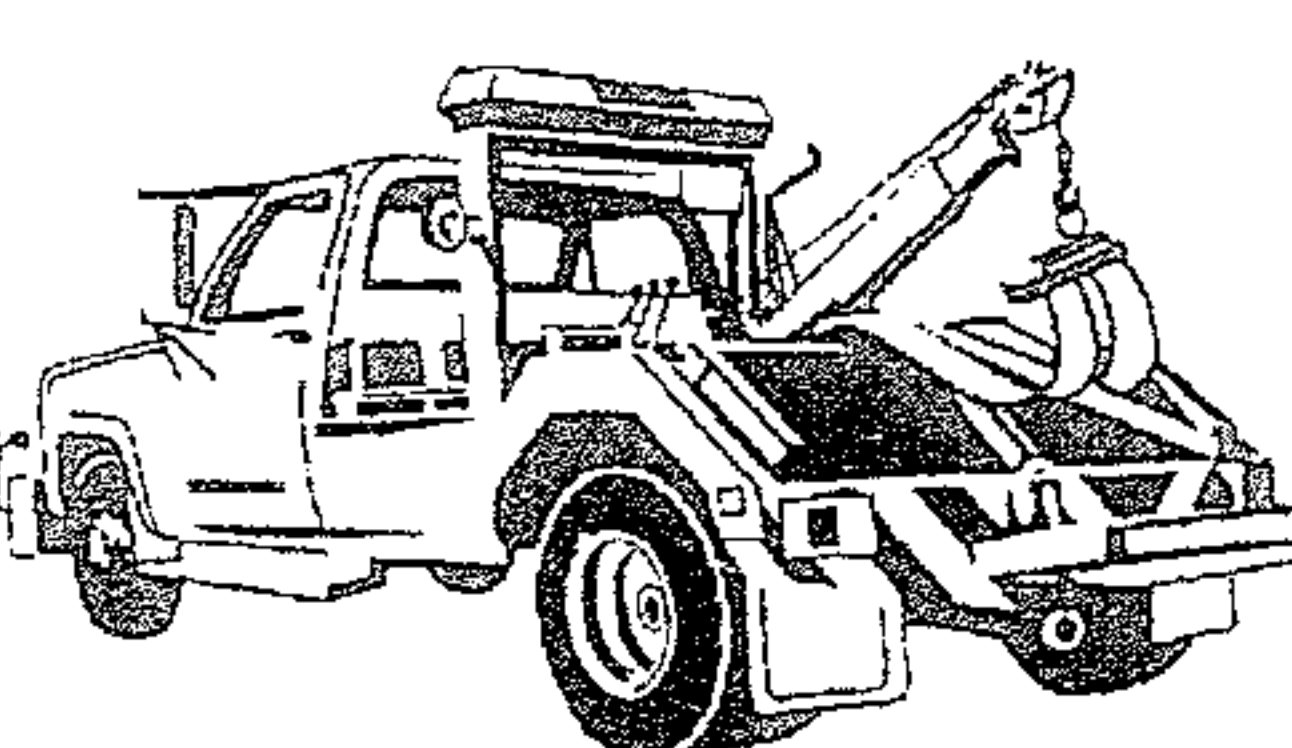

team ctd. from pg. 2
tive ran the vin which came back stolen out of Florida. Detective then contact LPD.

The owner was contacted and stated that he had the motorcycle listed on Craiglist and a Michael Giles stated he was interested in purchasing the motorcycle.

Victim stated Michael was following

him to Walmart so someone could wire him the money on the motorcycle.

Victim stated when he exited the freeway Michael accelerated and continued on up the freeway. The motorcycle was reported stolen.

Michael was placed under arrest. Detective Brian Jenkins LPD, made the arrest.

Help Wanted

Experienced Dispatcher Needed At Moneymaker Wrecker Service

Apply in person at 11776 Hwy 70, Lenoir City

BUDGET Transmissions

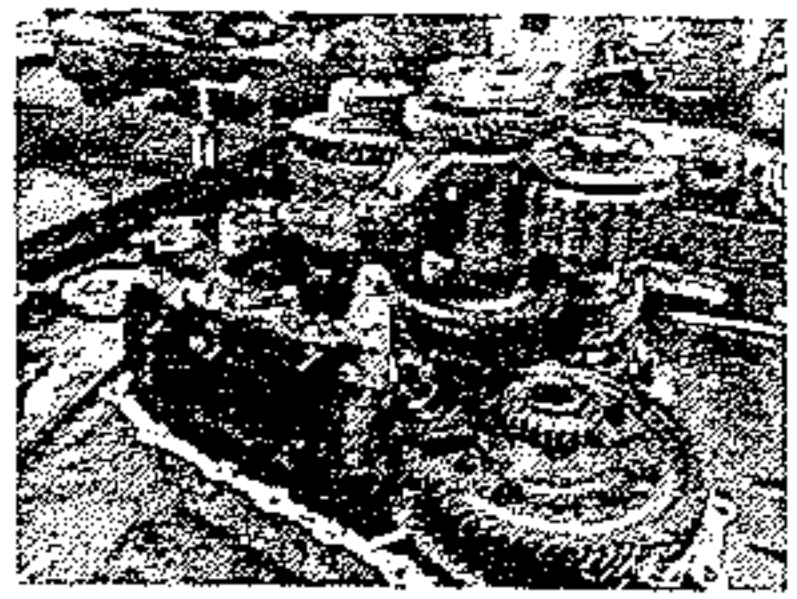

302 S. Northshore Drive Knoxville

(865) 584-4391 budget-transmissions.com

Why Buy From Budget?

Free Towing From Lenoir City or Loudon County

20 Years of BBB Zero Customer Complaints Award Member
A+ Plus Rated

Huge Transmission Inventory

Best Technicians Period!!!

Call (865) 584-4391 Today!

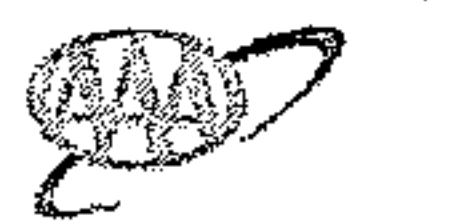

Approved Auto Repair



NEED HELP WITH INCOME TAX? PROFESSIONAL TAX SERVICE

PRICE - 95% of returns between \$60-\$140

(No Coupons Required)

LOCALLY Owned & Operated - Open Year Round

30+ Years in the business

ALL Preparers with 10+ years experience

Pro Tax

111 E. Broadway
Lenoir City, TN 37771
Phone 865-986-4035

**US Armed Service Active Duty Personnel, "THANK YOU", Tax Return Free*

good to know you™

IMMEDIATE OPENINGS!

Randstad is NOW HIRING for 2nd shift Assembly Positions at Commercial Vehicle Group. These are long-term, temp-to-hire positions!

Hours: 4:30pm - 3:30am (end times vary)

Pay: \$10/\$10.50 per hour

You may apply by visiting our Facebook page www.facebook.com/vonorejob and clicking the "Sign Up" button. You can also get a paper application from the Guard Shack at 200 National Drive, Vonore, TN 37885.

For questions, call 423.884.4733

www.randstadstaffing.com

EOE



Staffing | Professionals | Search & Placement | HR Solutions | Inhouse Services

LCSO

William Mashaw, 41, Deeps Wood Lane Seymour, was charged with Simple Possession, and Poss. of Drug Para. Sgt. Jerramie Bowen LCSO, was patrolling Harrison Hill Subdivision, and noticed a maroon vehicle and the driver not wearing a seatbelt. Deputy made a traffic stop on Clarke Road

and made contact with the driver identified as William Mashaw. William was very nervous and had trouble finding his driving license. Deputy could smell the odor of marijuana coming from the vehicle. William stated he did not have anything in the vehicle. Deputy did notice 2 small cylinders hanging from the rear view mirror. Deputy did locate a

Xanax in one cylinder. Deputy also located a bag in the trunk with several needles and a pipe with residue believed to smoke crack cocaine. William was placed under arrest. Sgt. Jerramie Bowen LCSO, made the arrest.

GS

Entertainment will be the dynamic singing duo known as Vo-

cal Point.

Tickets are \$40 each, of which 20 dollars is income tax deductible. For those who wish to support the Good Shepherd but are unable to attend this function, there are Feed a Family tickets available, also \$40 each.

Tickets may be purchased at The Good Shepherd Center, The Monroe County Chamber of Commerce, the Kahite Club House

and individual Good Shepherd volunteers.

The Good Shepherd Center is a 501©3 organization.

Some of the things The Good Shepherd Center provides are food to over 2,100 men, women and children every month, personal care items as requested, clothing to each person per household, miscellaneous items each month, transportation via ETHRA for medical appointments, emergency housing for fire victims, layette sets for newborn babies and utility vouchers.

The Good Shepherd Center is supported financially by churches, local businesses, and individuals. Additional funds are provided through grants, auxiliary groups, Monroe County governmental agencies and fundraising events such as this Dinner/Auction event.

Award ctd. from pg. 3 community program is more important to him than HonorAir Knoxville. He not only spearheads the organization, operation and fund raising efforts, his company also bears the cost of all administrative support for the program. Mannis ensures that every dollar donated is applied directly to the cost of the flights and that the fund raising goals are met. The 19th flight departed and returned on Wednesday, October 7, 2015 from the McGhee Tyson Airport in Knoxville, Tennessee.

HonorAir Knoxville

(see Award ctd. pg. 7)

PURDY'S AUTO PARTS AND SALVAGE
WE BUY SCRAP IRON • COPPER • BRASS • ALUMINUM

\$

Paying Top \$\$\$
Call For Latest Prices

You Name It, We Buy It!

Radiators, Wheels, Batteries, Appliances, Farm Equipment

Copper
Paying Top \$\$\$
Call For Latest Prices

You Call We Haul!
423-519-5402



Prices subject to change with the market.

423 337-3977
149 County Road 323 Sweetwater

Complete Cars
per 100 lbs.

Scrap Metal
Paying Top \$\$\$
Call For Latest Prices
per 100 lb

We Buy Batteries

Aluminum Cans
Paying Top \$\$\$
Call For Latest Prices

Now Selling
Aftermarket
Body Parts at
Discount Prices

Prices subject to change with the market.

FBI

Jackson County received eight audit findings in its fiscal year 2015 report. Six of these findings were also noted in the previous year's report but had not been corrected.

Additional findings in the report include problems with purchasing procedures, expenditures exceeding appropriations, multiple employees using the same cash drawer, and a failure to separate money-handling responsibilities in several county offices.

"Jackson County leaders should work with TCRS to correct this situation," said

Comptroller Justin P. Wilson. "I would also encourage county officials to follow the recommendations in the audit report to address our auditors' findings. All 95 Tennessee counties have an Audit Committee which can be very useful in mitigating risk and improving internal controls."

To view the audit online, go to: <http://www.comptroller.tn.gov/la/>

If you suspect fraud, waste or abuse of public money in Tennessee, call the Comptrol-

ler's toll-free hotline at (800) 232-5454, or file a report online at: www.comptroller.tn.gov/hotline. Follow us on twitter: @TN-COT

Award ctd. from pg. 5

was established by Mannis in 2007. It is an organization dedicated to honoring the World War II Veterans of East Tennessee and the sacrifices they made to ensure our country's freedoms by flying each veteran free of charge to Washington D. C. to see the World War II Memorial built in their honor. He learned about HonorAir from a friend in North Carolina who started the National HonorAir Program.

Mannis decided to initiate the program in Knoxville to honor his father, who was a Veteran of the Korean War, and his uncle and stepfather, who both were World War II Veterans.

The program would not be possible without the support of the community, businesses, and individuals that have volunteered and or made financial contributions. All World War II, Korean and Vietnam Veterans, regardless of physical limitations, are also eligible to participate.

The one-day trip, which is provided at no cost to the veterans, includes the following:

- Roundtrip airfare via a chartered Ameri-

- can Airlines plane;
- Meals and snacks;
- Chartered bus tour of the World War II Memorial, Tomb of the Unknown Soldier, the Marine, Navy, Air Force, Vietnam and Korean War Memorials; and

- Commemorative items including a hat, book and DVD with highlights of the trip.

Flights are conducted twice a year during the months of April and October. The next flight is scheduled for Wednesday, April 13, 2016.

Mannis is a graduate of the FBI Knoxville Citizens Academy and has also been recognized by the following organizations:

see Award conc. pg. 8

Help Wanted

Position Available Immediately! Apply in person at the Kenjo Marathon on Hwy 321 in Lenoir City.

LOOK!

\$75 Weekly Payments

LOOK!

MARTY'S AUTO SALES • 986-2222 • MARTY'S AUTO SALES • 986-2222 • MARTY'S AUTO SALES • 986-2222 • MARTY'S AUTO SALES • 986-2222 • MARTY'S AUTO SALES • 986-2222

Bad Credit
Divorce
Fixed Income
Repos
Bankruptcy
No Credit



APPROVED!

Visit Us On The Web At:
martyautosales.net

NO CREDIT CHECKS



\$499 down*

07 Cobalt, 5spd, gas saver, runs great Only \$499 down*

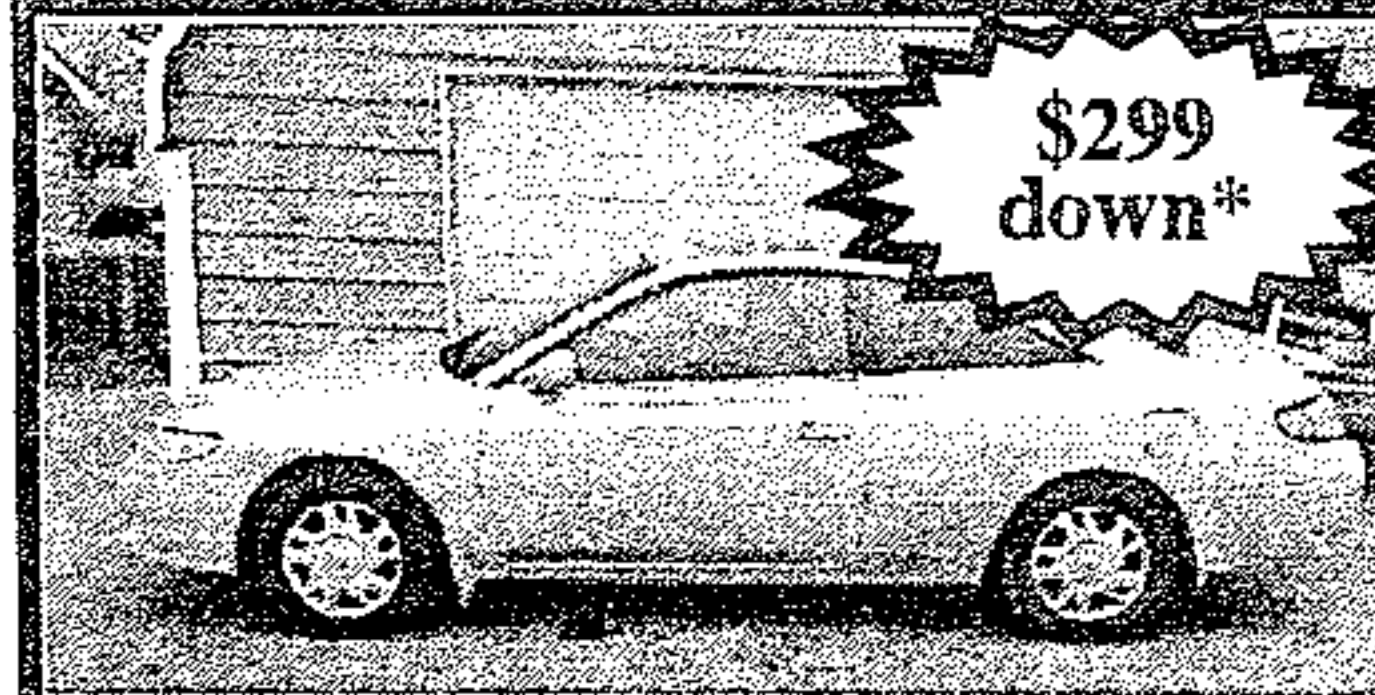

\$299 down*

99 Solara, V6, auto, sporty, Only \$299 down*

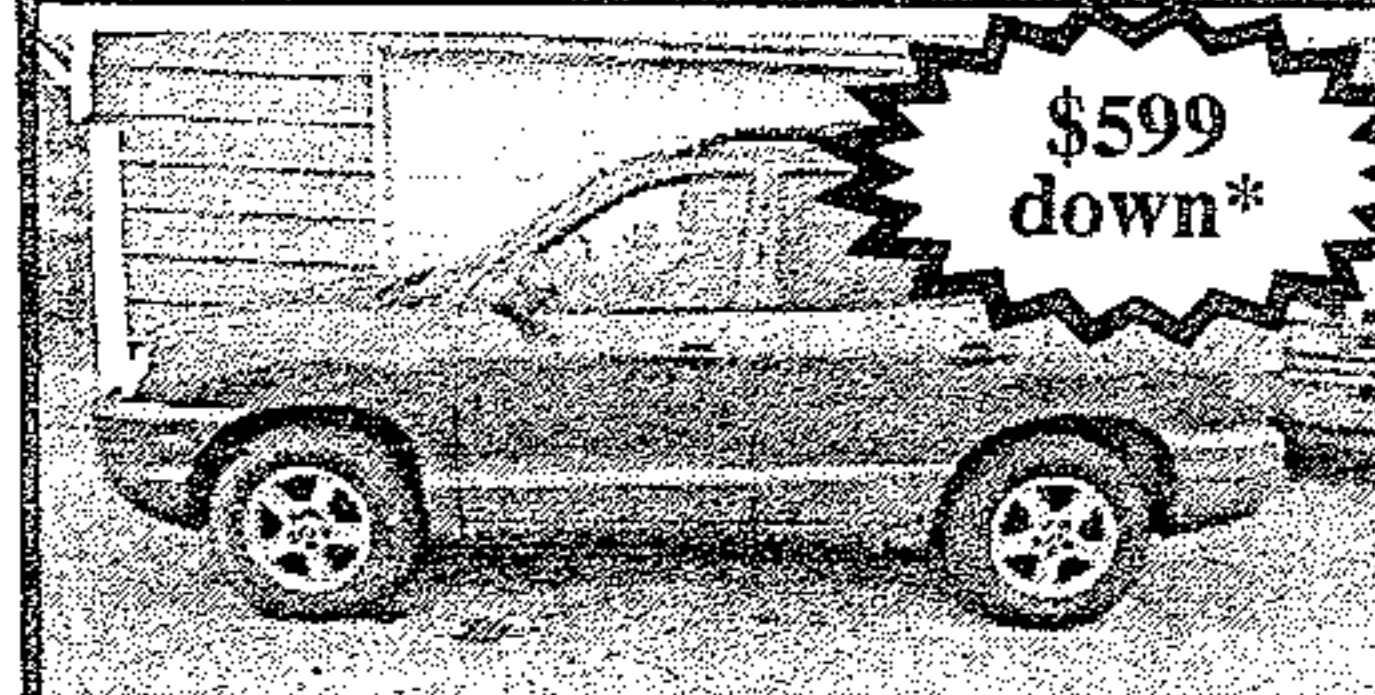

\$599 down*

04 Santa Fe, auto, Nice, clean. Only \$599 down*

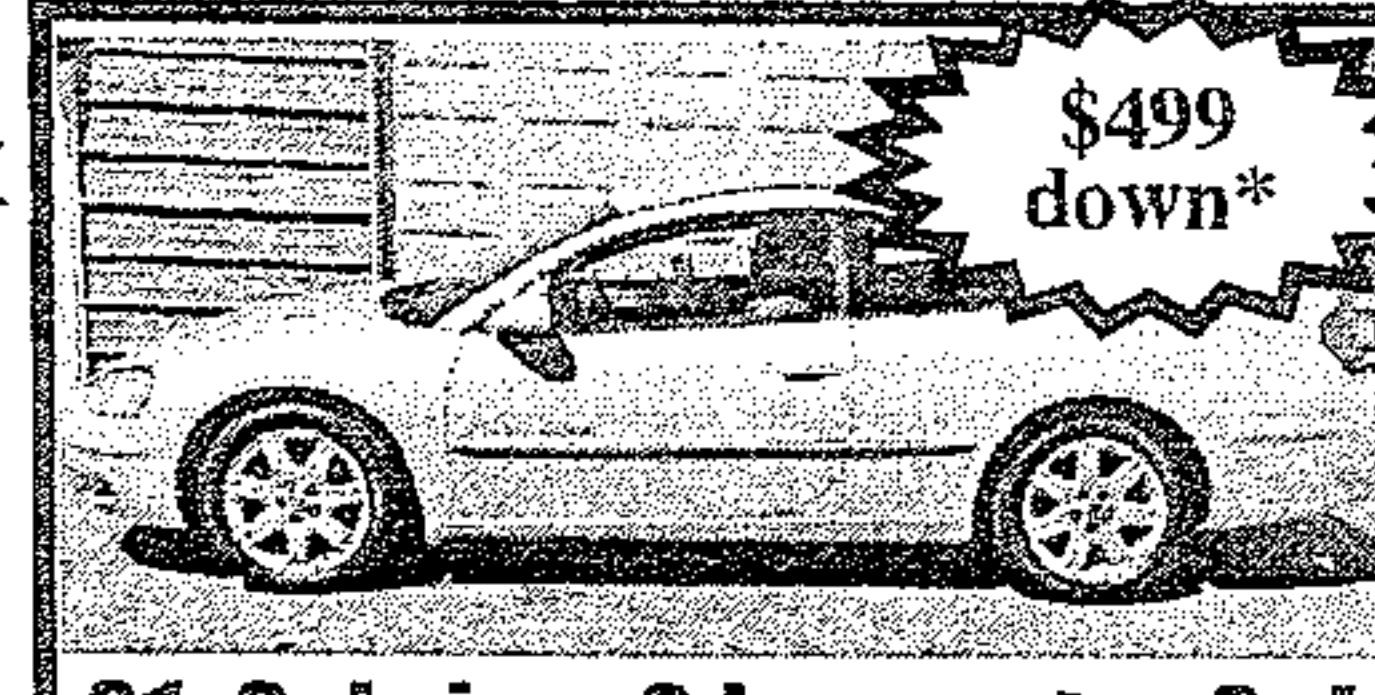

\$499 down*

01 Sebring 2dr. sporty, Only \$499 down*



\$599 down*

05 Trailblazer, auto, good miles Only \$599 down*



\$499 down*

04 Aveo, auto, gas saver, Only \$499 down*



\$799 down*

06 Tiburon GT, 5 speed, sporty, Only \$799 down*



\$99 down*

98 Bonneville, 6 cyl, Auto, low payments only \$99 down*

NO Credit Checks

Marty's Auto Sales
986-2222

Se Habla Espanol

100% Approval*

*See Dealer for details. All down payments plus tax, tag, title and fees.

MARTY'S AUTO SALES • 986-2222 • MARTY'S AUTO SALES • 986-2222 • MARTY'S AUTO SALES • 986-2222 • MARTY'S AUTO SALES • 986-2222 • MARTY'S AUTO SALES • 986-2222

FBI ctd. from pg. 7

- 2013 Tennessee Volunteer of the Year by the Air Force Association of Tennessee

- 2011 Person of the Year Award by East Tennessee PBS

- 2011 Service to Mankind Award by the Sertoma Club

- 2010 Community Leadership Award by the Woodmen of the World

- 2010 Service Advocate Volunteer Award by Covenant Health

Eddie Mannis will be recognized at a ceremony at the FBI Headquarters in Washington, D. C. on Friday, April 15, 2016.

THE RELIC SHOP

521 Hwy 321 Lenoir City Suite 3
next to Stained Inc and the Inn of Lenoir
865-250-9280

WE ARE IN TUCSON, ARIZONA BUYING UP FOSSILS FOR THE SHOP. WE NEED TO MAKE ROOM!!!

ALL AMETHYST 40% OFF

GREAT SELECTION OF ANCIENT MEGALADON SHARK TOOTH OVER 8 MILLION YEARS OLD

Is Your Washer Broken?

Call Me

I Only Charge \$100 Period!!!

Call Allen

865-617-7113

A Name You Already Know And Trust Just Got Even More Dependable
DEPENDABLE AUTO SERVICE, LUBE AND TIRES
is Now Offering
Expert, Affordable Transmission Service

All ASE Certified Technicians

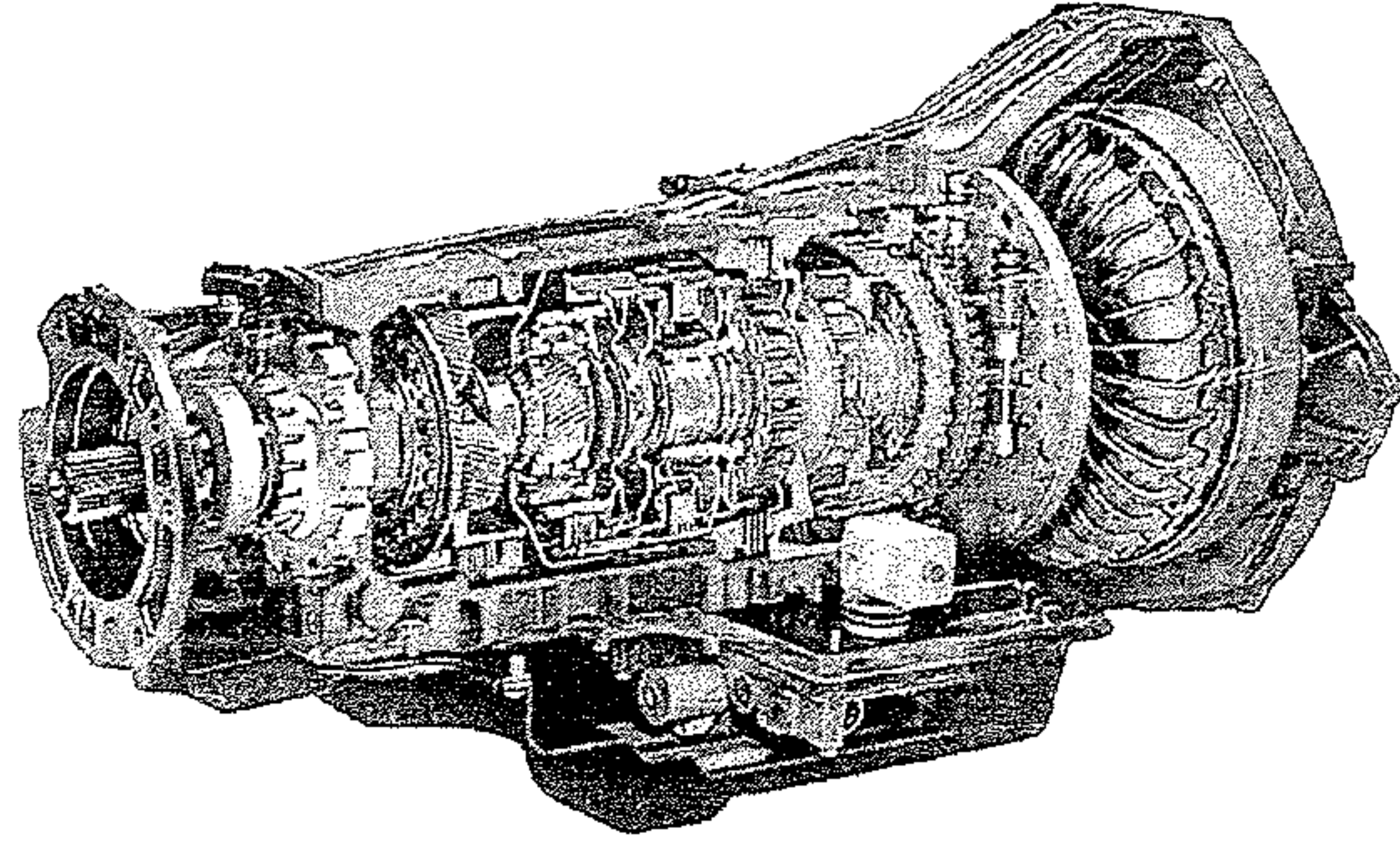

We proudly welcome all New Customers and Former Advanced Transmission Customers with a 10% Discount and Any Transmission Service or Repair*

865-986-9359

865-986-5050

Bad Credit, No Credit OK!!! We Finance Everybody!!!

Taxes Done Here!!! Bring your last pay stub or W2 and DRIVE TODAY!!!

Over 100 Cars, Trucks & Vans in Stock - Warranties On ALL Vehicles Sold!!!



2005 Ford Ranger, Super Nice Truck, Very Low Miles

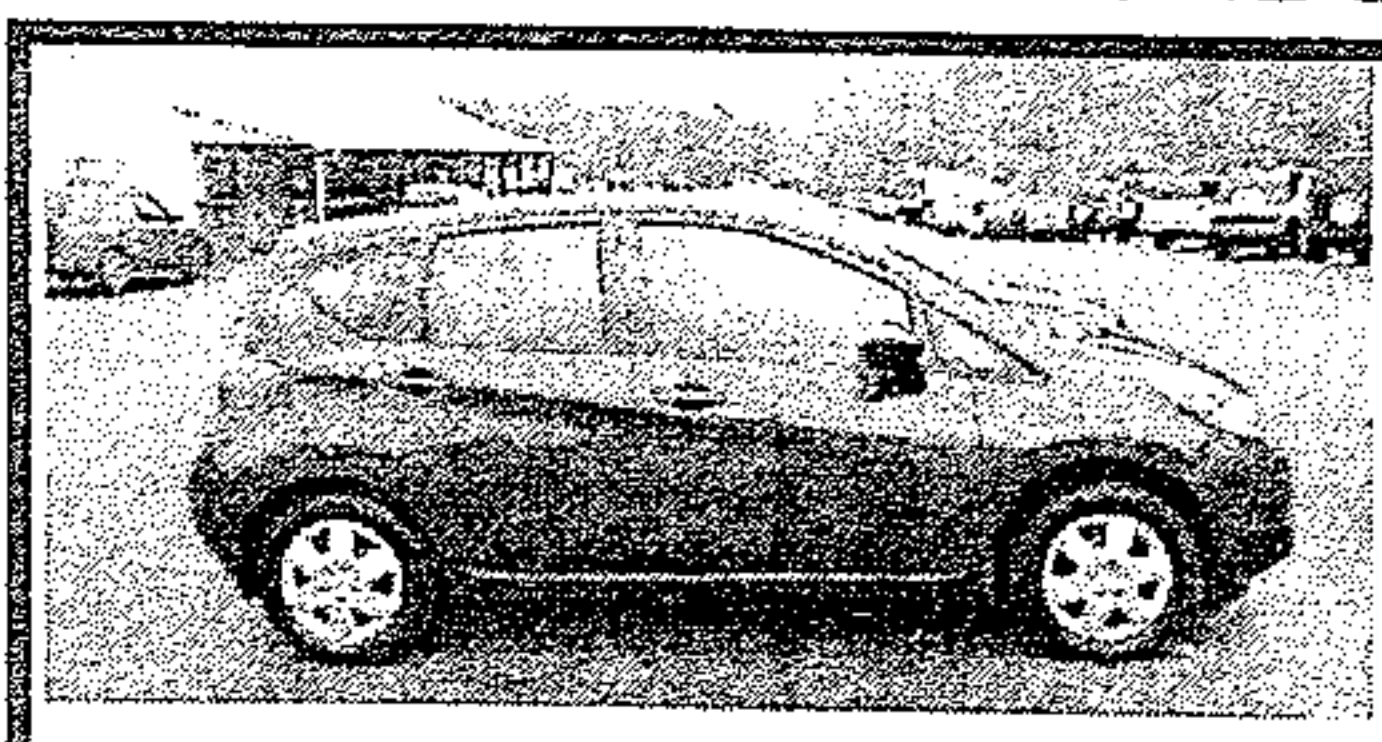

2015 Nissan Versa Note, Factory Warranty, Low Miles



2011 Kia Soul, 5 speed, 4 dr, Gas Saver, Nice & Clean



2008 Saturn VUE, LOADED!!! 4dr, Ready to go on a trip!

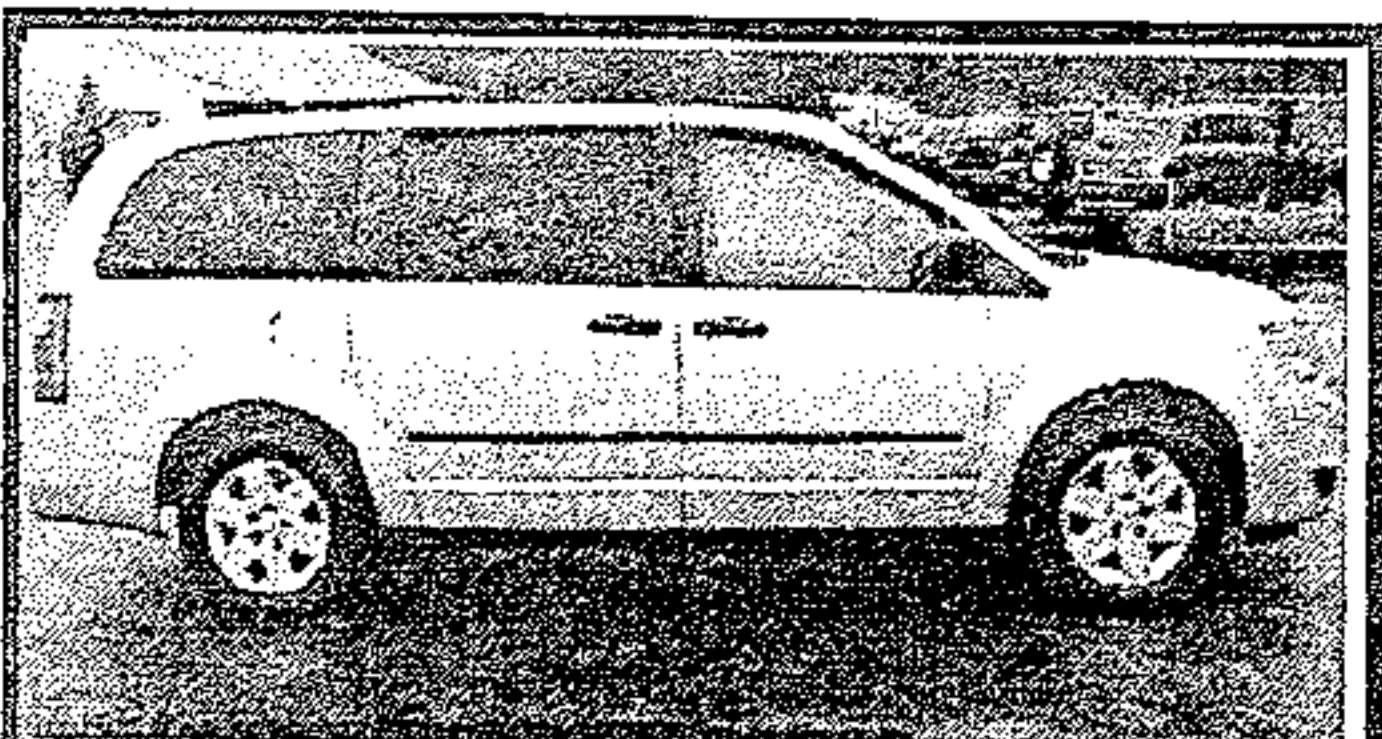

2008 Dodge Grand Caravan, Nice, Clean, Stow n Go!

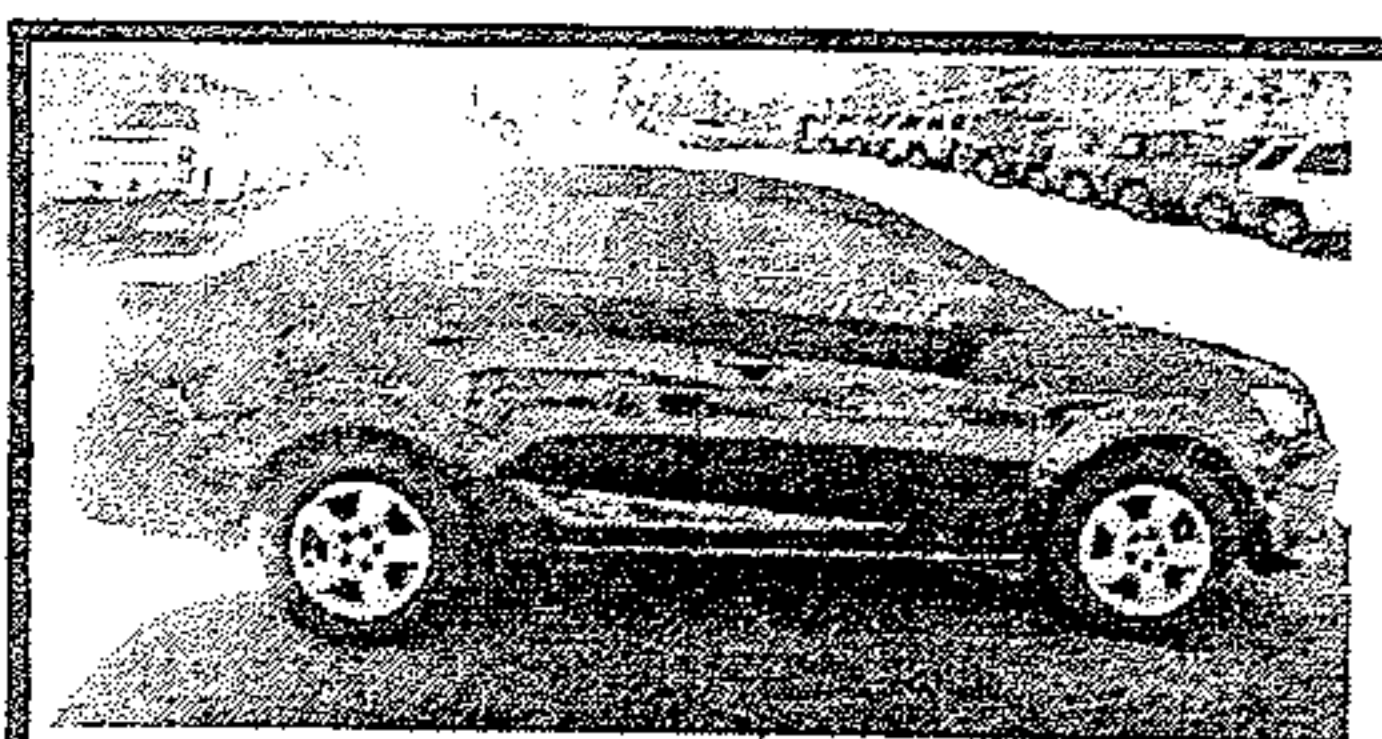

2014 Chevy Sonic, Factory Warranty, Low Miles!



Mitsubishi Raider, Ext. Cab, Super Nice Truck

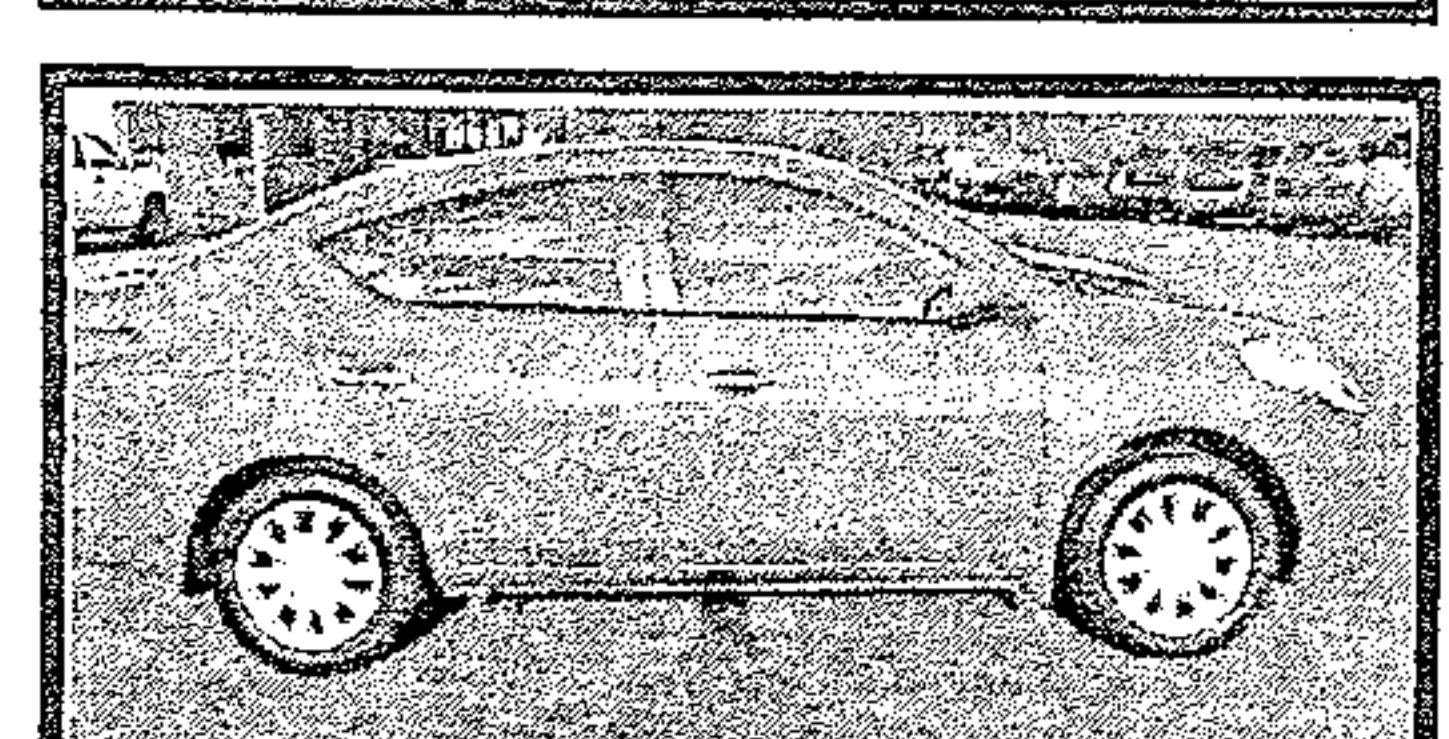

2013 Nissan Versa, Like New! LOADED!!!

WALT WILLIAMS, INC.

*with approved credit

3003 Highway 11

Lenoir City, TN

865-986-1111