

The Daily Edition

50¢

Serving Loudon, Monroe and Surrounding Counties

Tuesday, March 8, 2016

9th DTF, LCSO and LCPD team up in meth search



Bobbi Jo Gilbert

(see team pg. 2)

Meth offender charged in LC



Jarrod Hunt

(see meth pg. 5)

Gun used in aggravated assault

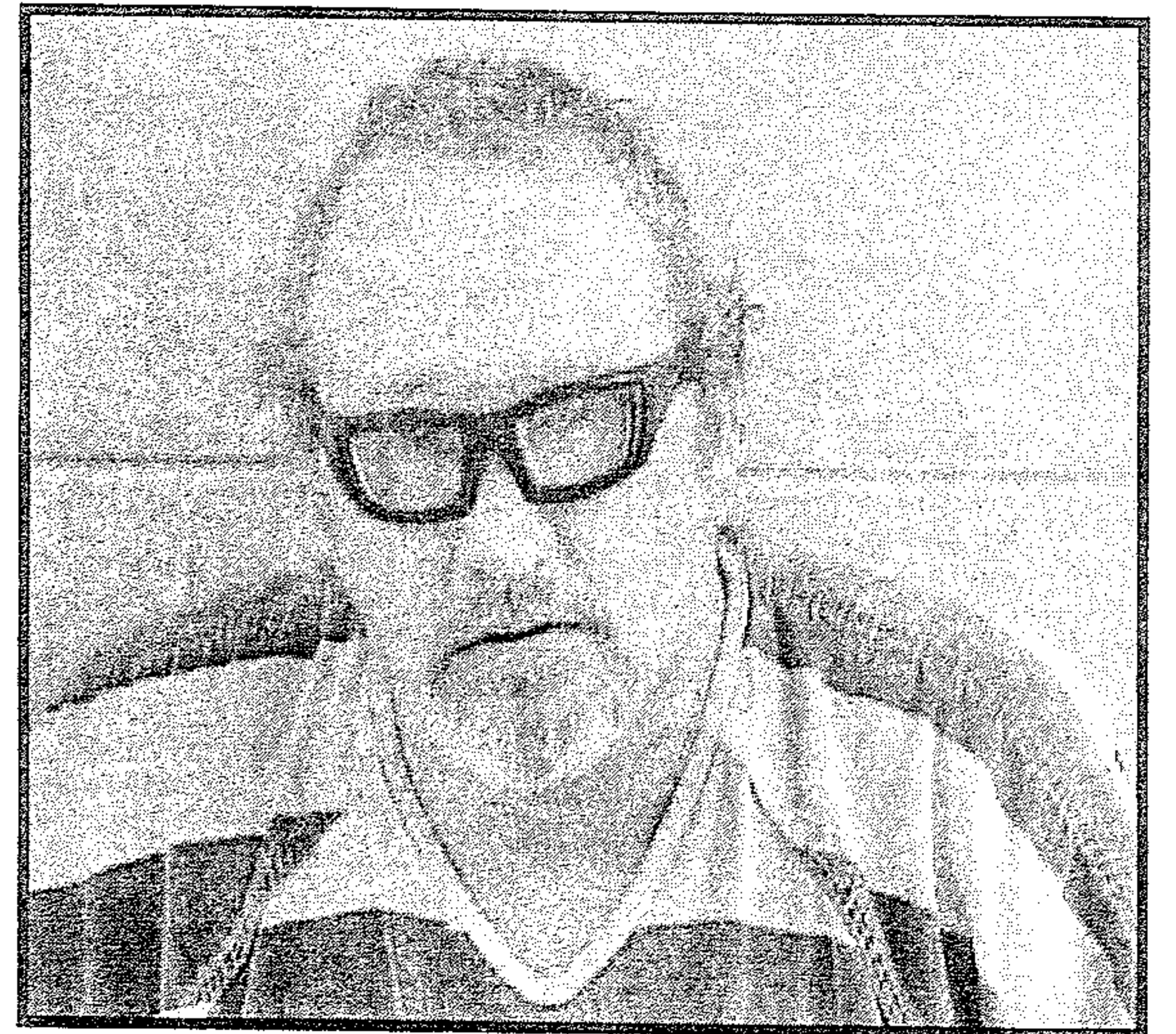

Glen Rucker

(see gun pg. 3)

FBI Assists Polish Government in Recovering Painting Lost During WWII

In July 2015, when Special Agent Paul Zukas began his first day on the job at the FBI legal attaché office in Warsaw, Poland, little did he know his initial case would involve helping the country's Ministry of Culture and National Heritage recover a treasured painting allegedly looted by Nazi soldiers during World War II.

Zukas' deep appreciation for art, history, and culture would be his guide during

(see FBI pg. 7)

Pickett County's Highway Superintendent Admits to Misuse of County Resources

A special investigation by the Tennessee Comptroller's Office has found that Pickett County Highway Superintendent Jimmy Cope directed county-purchased gravel and rock to be delivered to private property.

Mr. Cope admitted that he ordered the gravel and rock to be transported by county employees driving county trucks to be

(see misuse pg. 5)

Verse of the Day

Trust in the LORD with all your heart and lean not on your own understanding; in all your ways acknowledge him, and he will make your paths straight. — Prov-

verbs 3:5-6

Obituaries

see inside
Wazzup

What a beautiful week it is going to be this week! Get out and enjoy it!

Weather

Today: Partly cloudy. High 73F.

Tonight: Mainly clear skies. Low 46F.

Wednesday Sunshine and clouds mixed. High 76F.

Wednesday Night Mostly cloudy skies. Low 52F.

Horoscopes

Pisces 2/19-3/20

Inspirational people share their brilliant ideas with you today, enticing you to join them on their journeys. The Sun in your dreamy sign opposes lucky Jupiter in your 7th

(Continued on page 6)



team

Bobbi Gilbert, 27, Kelly Lane Lenoir City, was charged with Simple Possession, and Poss. of Drug Para.

Agent 9th JDTF, LCSO, and LCPD, executed a search warrant at McGhee Square Apt. Bobbie Gilbert and a male reside at this residence. During the investigation

Agents recovered a home-made pipe used to smoke methamphetamine, digital scales, two firearms, and a small amount of marijuana. Bobbie was present at the time of the search. Agents found the male had left the residence just prior to their arrival. The male cell phone was still on the night stand

(see burglary ctd. pg. 4)

Call 865-771-2249 to Advertise and start saving today!
Has your group got an event coming up?
Let us know!!!

To Get a Burning Permit:

Loudon (865) 986-8395
 Monroe (423) 442-7401
 Roane (865) 354-1054

Notice: The Daily Edition does not knowingly accept fraudulent or misleading materials. The Daily Edition cannot guarantee the validity of offerings or statements contained herein. All liability for the contents of all advertising, and for any claims that may arise therefrom, is the responsibility of the advertiser or its agency. The Daily Edition reserves the right to reject, edit, or abbreviate any advertisement submitted. Advertising is accepted with the understanding that all liability for all copyright violations is the sole responsibility of the advertiser.

Photographs, artwork and other copy submitted for publication is considered the sole property of the advertiser. The Daily Edition will make every effort but will not be liable for failure to publish and ad or for typographical and layout errors. All statements and information about highlights featured items, letters to the editor, herein are those solely given to the interviewer or writer and the Daily Edition assumes no responsibility of the accuracy or validity thereof. The Daily Edition will gladly reprint at no charge that part of an advertisement in which an error occurs provided a claim is made within 3 days of the first publication of the ad. Information contained in the Wazzup is received anonymously and the Daily Edition assumes no responsibility for information and reserves the right to edit or reject any and/or all submissions. The Daily Edition is a daily newspaper of general circulation in Loudon County defined under TCA 2-1-104(a)(13).

The Daily Edition also serves Monroe, Knox, Anderson, Roane and Blount counties and serves 30,000 readers weekly. Send mail to PO Box 1240, Lenoir City TN 37771. 865-771-2249. email: dan1204us@yahoo.com

The Daily Edition is Loudon County's premier public interest and paid advertising paper. The Daily Edition is produced and published daily Monday through Friday and is circulated throughout Loudon County and parts of Monroe and Knox Counties. Display advertising rates \$5.00 per column inch and quantity discounts available. Call for information on upcoming promotions and events.

HACIENDA Ayala's
Mexican Restaurant
 Market Dr. * Lenoir City (In Front of Food City)

Real Authentic Mexican Food at Affordable Prices

BEST MARGARITA

You've Tried The Rest Now Come Have The Best!!!

We Accept ALL Competitors Coupons Outside of Mexico City!

986-3553

Good Credit OK • Bad Credit OK • Bankruptcies OK • Repo OK



2010 Kia Soul Sporty, 4 cyl, Auto, PW, PL, A/C, Great On Gas, Like New



2010 Ford Escape Limited Leather, Alloy Wheels, Heat, A/C, Luggage Rack, 79K,



2007 Dodge Ram 1500 Quad Cab, Thunder Road PKG, 20 in. Wheels, Low Miles, Hemi



2008 Ford Explorer 84k, 3rd Row Seating, Luggage Rack, Tow Pkg, PW, PL



2011 Ford Ranger Low Miles, Tow Pkg, New Tires, A/C, Heat, Bed Liner.



2011 Dodge Grand Caravan DVD, Stow & Go, Loaded, Remote Doors, Rear A/C

DEPENDABLE MOTORS 986-9343

803 E. Broadway • Lenoir City

Serving Loudon County for 20 Years

* WAC. See Dealer for details

Visit our website at: www.dependablemotorslc.com

gun

Glen Rucker, 53, Cook Drive Loudon, was charged with Aggravated Assault. Inv. Jeff Russell LCSO, responded to Grandview Drive Loudon to investigate an ag-

gravated assault involving a handgun. Deputy arrived to find victim upset and stated a white male driving a small white truck had stopped in front of his residence, when victim ask the male what he was doing, the male started talking about kids stealing in the neighborhood. Victim ask what he was talking about, the male stated to victim he hoped victim cherished his kid and reached into a bag and pulled a black pistol out. When victim seen the gun

he ran and told his girlfriend on from the bag but never to call police. The male was identified as Glen Rucker, Glen was placed under ar- rest. Inv. Jeff Russell LCSO, did admit to taking the weap- made the arrest.

For Sale: oak Wood Mulch

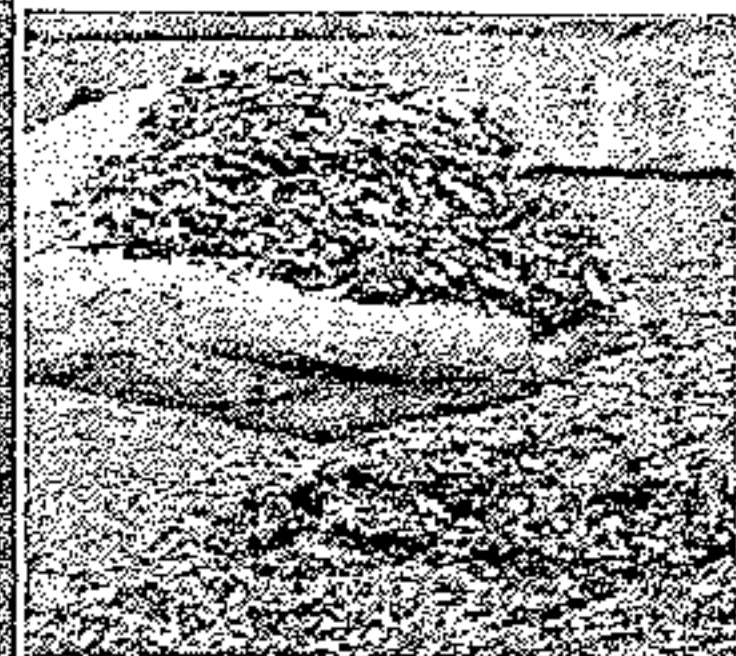

Mushroom Compost Topsoil.

Firewood

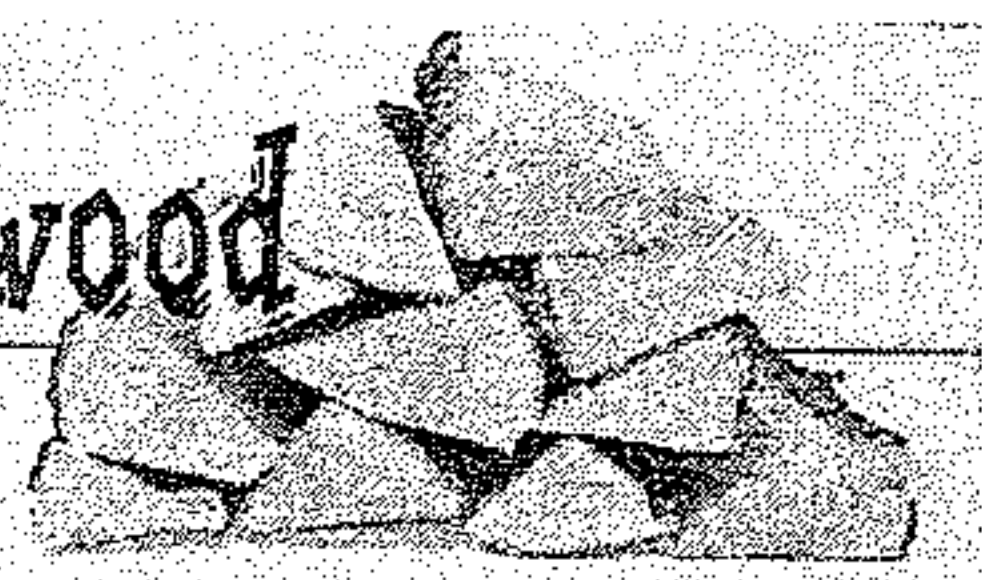

Call Steve Spoon 986-4282

The Daily Edition

serving Loudon and surrounding counties since 1986

C&C Lawn Care
Mowing, Mulching, Trimming, Edging, Clear Debris
Free Estimates
Call Chad 865-271-8070

West End Storage & Warehouses
502 Ward Avenue • Loudon
Call 865-458-4774 or 865-679-5555

C&J Towing and Recovery
LOWEST TOWING RATES AROUND!!!

Have you been overcharged for any type of towing service in the Lenoir City area? If you have a breakdown or accident please OWNER REQUEST C&J Towing with the officer. Also please call your Sheriff and ask him to place C&J Towing on the "Rotation List*" and help other motorists save as much as you did! We at C&J are locally owned and operated, State approved, licensed, bonded and insured. Call and let us know if your denied service or how we can be of assistance.

*note: the "Rotation List" is a list of wrecker services that provide service for wrecks, DUI's, breakdowns, etc. and are on an on-call basis for service. This list is approved by the Sheriff.

Cliff Teeters • Owner
865-809-1661

STAINED INK
TATTOO & PIERCING
LENOIR CITY 865 816-6440
NEW OWNER • NEW ARTIST • SINCE 2011
521 Hwy 321 next to Vape & Stuff & Inn Of Lenoir!
Clean-Affordable-Quality-Custom
Tattoo's You've Always Wanted!

BRING IN THIS Ad FOR **\$25 OFF!** Check us out on FB.com/
NEW INK FOR NEW CUSTOMERS ONLY! Stained.Inc.Tattoo/
www.STAINEDINC.com

BIMBO'S
Deli Open 24 Hours
865-986-9643 Call Ins Welcome

Specials

Lg. Cold Sub, bag of chips and 16 oz. fountain drink only \$6.29

Footlong Corn Dog \$2.59

team ctd. from pg. 2

next to the bed.

Agents have been involved in an investigation into the sale of methamphetamine occurring at the residence.

Bobbie was charged with Simple Possession and Poss. of Drug Para.

Agent Brendan De-Boer JDTF, made the arrest.

Domestic charges follow call to police

Travis McCollum, 43, Fairview Road Lenoir City, was charged with Domestic Assault. Deputy Kevin Dailey LCSO, was dispatched to Fairview Road in reference to a domestic disturbance. Deputy made contact with Travis McCullom who was carrying a

(see domestic ctd. pg. 5)

Help Wanted

Experienced Dispatcher Needed At Moneymaker Wrecker Service

Apply in person at 11776 Hwy 70, Lenoir City

BUDGET Transmissions

302 S. Northshore Drive Knoxville

(865) 584-4391 budget-transmissions.com

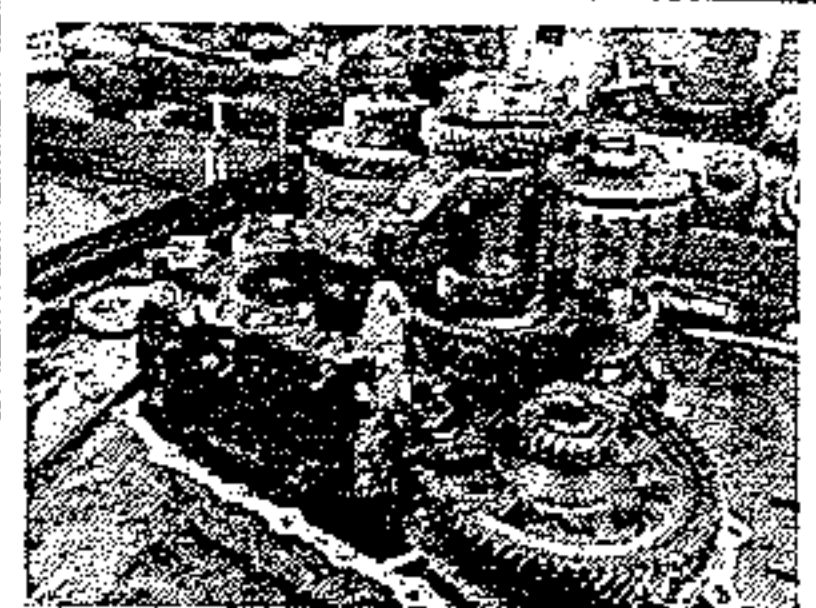

Why Buy From Budget?

Free Towing From Lenoir City or Loudon County

20 Years of BBB Zero Customer Complaints Award Member

A+ Plus Rated

Huge Transmission Inventory

Best Technicians Period!!!

Call (865) 584-4391 Today!



Approved Auto Repair



NEED HELP WITH INCOME TAX? PROFESSIONAL TAX SERVICE

PRICE - 95% of returns between \$60-\$140

(No Coupons Required)

LOCALLY Owned & Operated - Open Year Round

30+ Years in the business

ALL Preparers with 10+ years experience

Pro Tax

111 E. Broadway

Lenoir City, TN 37771

Phone 865-986-4035

**US Armed Service Active Duty Personnel, "THANK YOU", Tax Return Free*

good to know you™

IMMEDIATE OPENINGS!

Randstad is NOW HIRING for 2nd shift Assembly Positions at Commercial Vehicle Group. These are long-term, temp-to-hire positions!

Hours: 4:30pm - 3:30am (end times vary)

Pay: \$10/\$10.50 per hour

You may apply by visiting our Facebook page www.facebook.com/vonorejob and clicking the "Sign Up" button. You can also get a paper application from the Guard Shack at 200 National Drive, Vonore, TN 37885.

For questions, call 423.884.4733

www.randstadstaffing.com

EOE



Staffing | Professionals | Search & Placement | HR Solutions | Inhouse Services

meth

Jarrold Hunt, 35, Pine Street Madisonville, was charged with Immediate Methamphetamine Precursor. Jarrod Hunt entered the Walmart on Hwy 321 and attempted to purchase a box of pseudophedrine product. Jarrod was observed on video from the Walmart pharmacy approaching the counter

and trying to purchase the product. Jarrod is currently on the Drug Offender Registry in the State of Tennessee for prior drug offense. Jarrod was convicted of Possession of Methamphetamine in Monroe Co. By Jarrod attempting to purchase the pseudophedrine product Jarrod violated the Immediate Meth-Precursor Law. Deputy Chance Gray

LCSO, arrest Jarrod at the Loudon Jail.

misuse

placed on various private properties in Pickett County.

Based upon interviews with Mr. Cope and another highway department employee, they estimated that as many as four loads of gravel per week were placed on private property. Investigators estimate this practice

cost the county at least \$13,205 annually.

Mr. Cope claims that he never asked for votes and never received money in exchange for the gravel and rock. Mr. Cope told investigators he would provide county gravel to any Pickett County citizen who asked.

"This activity raises questions about use of taxpayer-funded resources, and it could

also place the county at risk," said Comptroller Justin P. Wilson. "Using county equipment on private property could expose the county to potentially unlimited liability in the event that an injury or damage occurred as a result of this practice."

To view the special investigation online, go to: <http://www.comptroller.tn.gov/repository/ia/pickettcounty-hwydept.pdf>

If you suspect fraud, waste or abuse of public money in Tennessee, call the Comptroller's toll-free hotline at (800) 232-5454, or file a report online at: www.comptroller.tn.gov/hotline. Follow us on twitter: @TN-COT

Domestic ctd. from pg. 4

child visible upset 100 yards from the residence. Travis stated him and his father had gotten into an physical domestic over his child being to loud which Travis decided to leave, when his father tried to stop him. Contact was made with the farther who stated Travis had gotten mad over him telling the child to be quiet, during the argument Travis stated to the father he was going to meet his maker tonight. The father was afraid for his well being. Travis was placed under arrest due to him being the primary aggressor. Deput Kevin Dailey LCSO, made the arrest.

PURDY'S AUTO PARTS AND SALVAGE

WE BUY SCRAP IRON • COPPER • BRASS • ALUMINUM

\$

Paying Top \$\$\$
Call For Latest Prices

You Name It, We Buy It!

Radiators, Wheels, Batteries, Appliances, Farm Equipment

Copper

Paying Top \$\$\$
Call For Latest Prices

You Call We Haul!

423-519-5402

Prices subject to change with the market.

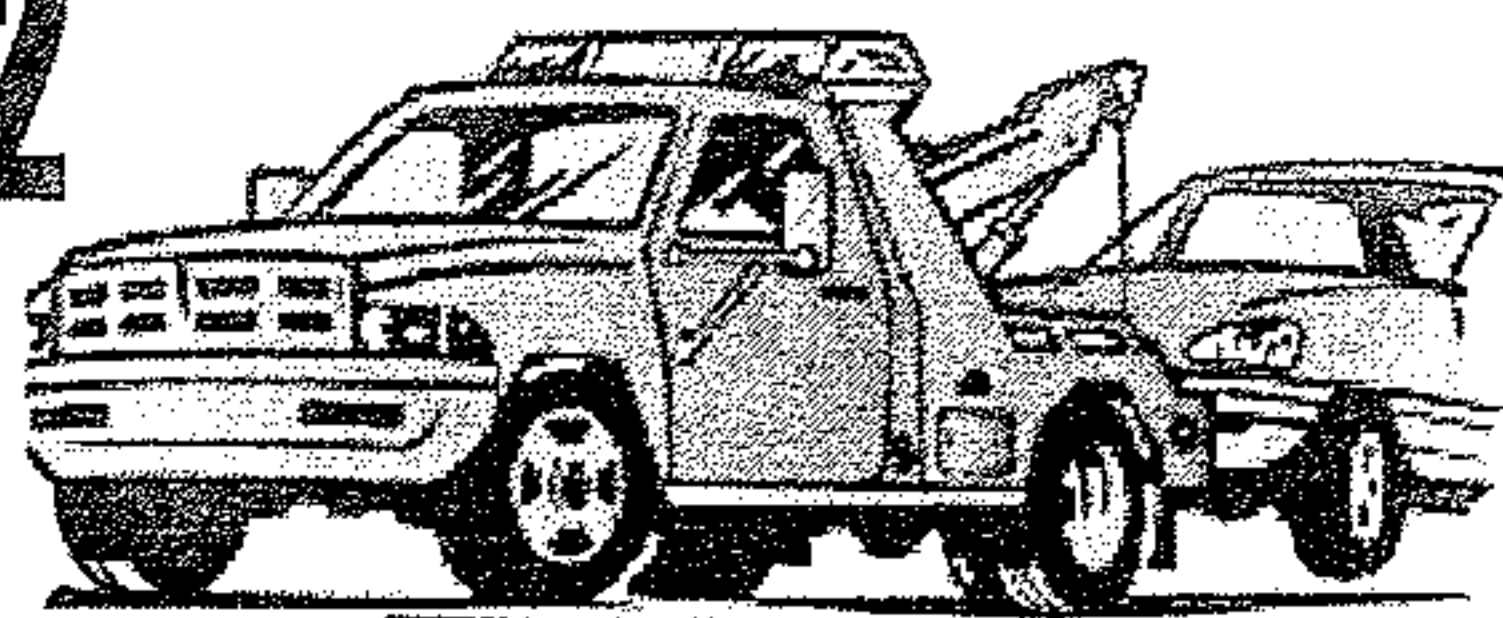

423 337-3977

149 County Road 323 Sweetwater

Complete Cars
per 100 lbs.

Scrap Metal

Paying Top \$\$\$
Call For Latest Prices
per 100 lb

We Buy Batteries

Aluminum Cans

Paying Top \$\$\$
Call For Latest Prices

**Now Selling
Aftermarket
Body Parts at
Discount Prices**

Prices subject to change with the market.

FBI

the Bureau's two-month investigation, which ultimately led him to an Ohio couple who had purchased the painting in question—unaware that it may have been looted.

"I was two days into my assignment in Warsaw when the case was handed to me," said Zukas. "I was beyond excited. When that case came to me, I knew was going to crack it. I was determined to find the painting and get it back where it belonged."

Poland's National Museum in Warsaw had been home to Polish baroque painter Krzysztof Lubieniecki's Portrait of a Young Man, completed around 1728. The painting—along with other artwork—purportedly had been taken by the Nazis circa 1944 and placed inside a palace in Austria before seemingly disappearing.

A possible clue about the missing painting surfaced in August 2009, when Bob Wittmann was leafing through an old stack of family photographs at his home in Detroit.

Wittmann had been conducting research on his late father's World War II service record when he came across a picture taken in 1945 of then 19-year-old Private John Wittmann in full service dress. The soldier was posing in uniform in his Columbus, Ohio home alongside a number of wartime mementos he collected during his time abroad.

The photograph showed an old painting

that Bob Wittmann recognized from childhood depicting a young man wearing a light blue coat and powdered wig. Wittmann also found a second photograph of the painting, which featured an inventory number and a phrase in a foreign language he didn't understand. Intrigued, he searched for the phrase on the internet and landed on the website of the National Museum in Warsaw. Wittmann later discovered a painting that looked like the one his father brought home from the war had been reported missing by the Polish government.

"There on the Polish Embassy's Wartime Losses web page was a picture of the painting," said Wittman. "The chills really kicked in when I saw the photograph on their website."

He eventually notified Poland's Ministry of Culture and National

Heritage about the missing painting and agreed to assist them in tracking it down, thinking it could still be in his family's possession.

Wittmann's search ended after he learned a relative in Florida sold the portrait through a third party to an Ohio art collector with the last name Bobb around 1990. The Polish government then turned to the FBI for help, and that's where Zukas came in.

After poring over his newly assigned case file, Zukas learned about Wittmann through all the correspondence he already had with the Polish government. "I knew about all the key players based on Bob Wittmann's extensive research and simply had to put the pieces together," he said.

Zukas picked up the phone and called John Bobb, the possible owner of the painting. Following their discussion,

Bobb realized that the painting the FBI was searching for could be the same one hanging on his dining room wall in Westerville, Ohio. In August 2015, Bobb e-mailed a photograph of the painting to Zukas, who knew instantly it was a match.

But was the painting authentic?

That September, Bobb and his wife, Janis, brought the portrait to the FBI's Columbus Resident Agency—a satellite of the Cincinnati Field Office—where they met with a member of the Bureau's Art Crime Team and officials from the Polish government. After a series of careful examinations, it was confirmed the painting in John and Janis Bobb's possession was indeed Portrait of a Young Man.

"Our minds were made up and we had already said goodbye to

see FBI ctd. pg. 8

Help Wanted

Position Available Immediately! Apply in person at the Kenjo Marathon on Hwy 321 in Lenoir City.

LOOK! \$75 Weekly Payments LOOK!

MARTY'S AUTO SALES • 986-2222 • MARTY'S AUTO SALES • 986-2222 • MARTY'S AUTO SALES • 986-2222 • MARTY'S AUTO SALES • 986-2222 • MARTY'S AUTO SALES •

Bad Credit
Divorce
Fixed Income
Repos
Bankruptcy
No Credit



APPROVED!

Visit Us On The Web At:
martysautosales.net

NO CREDIT CHECKS

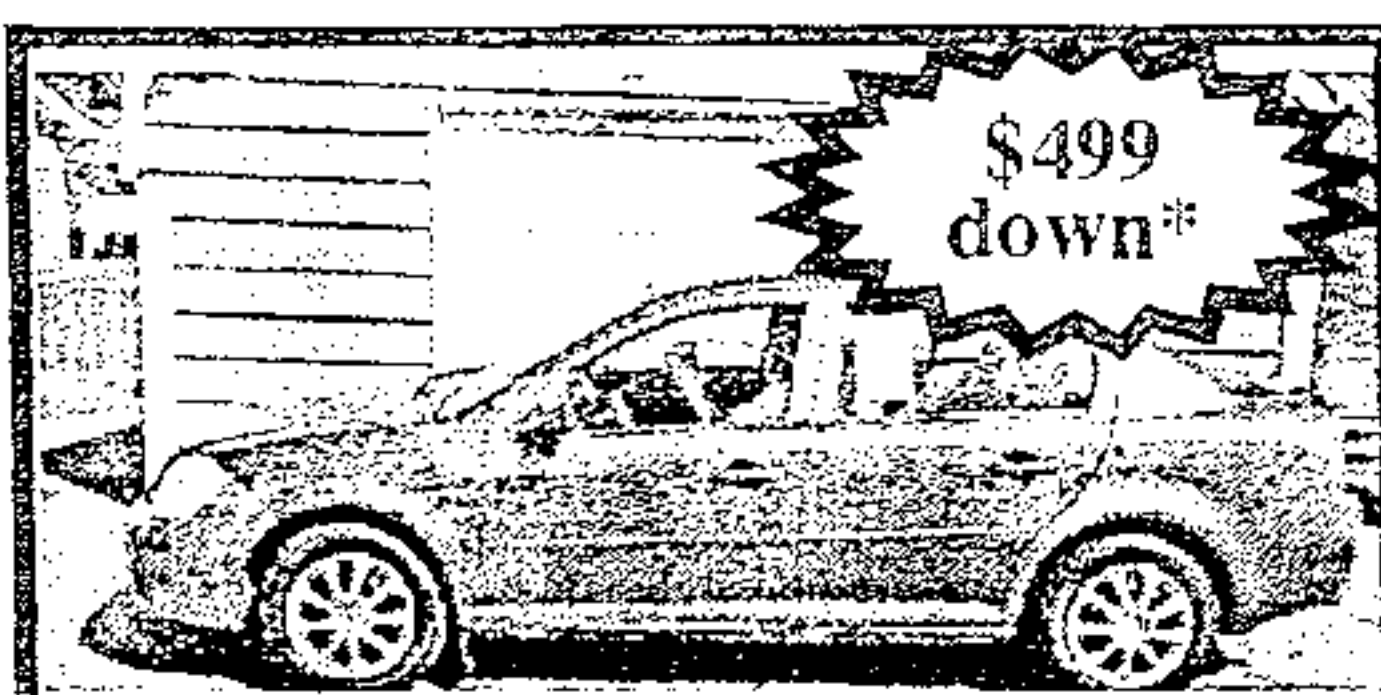

07 Cobalt, 5spd, gas saver, runs great Only \$499 down*

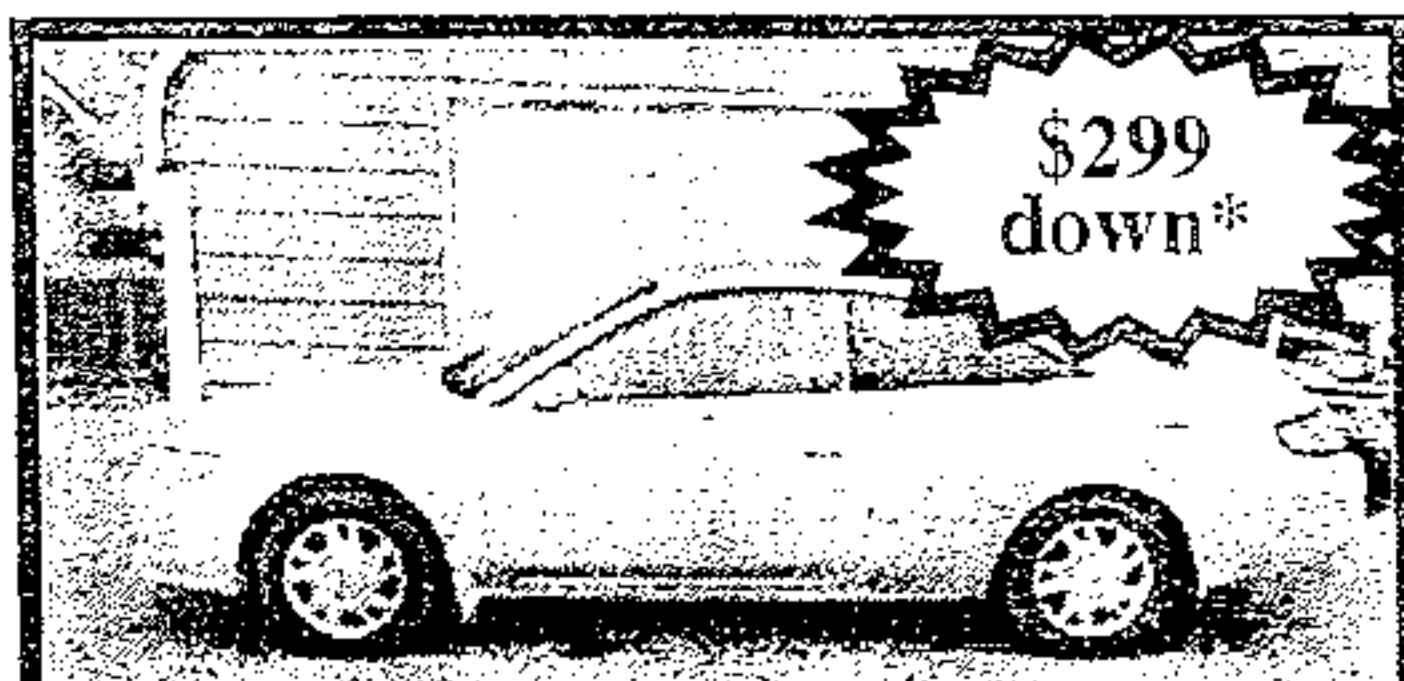

99 Solara, V6, auto, sporty, Only \$299 down*

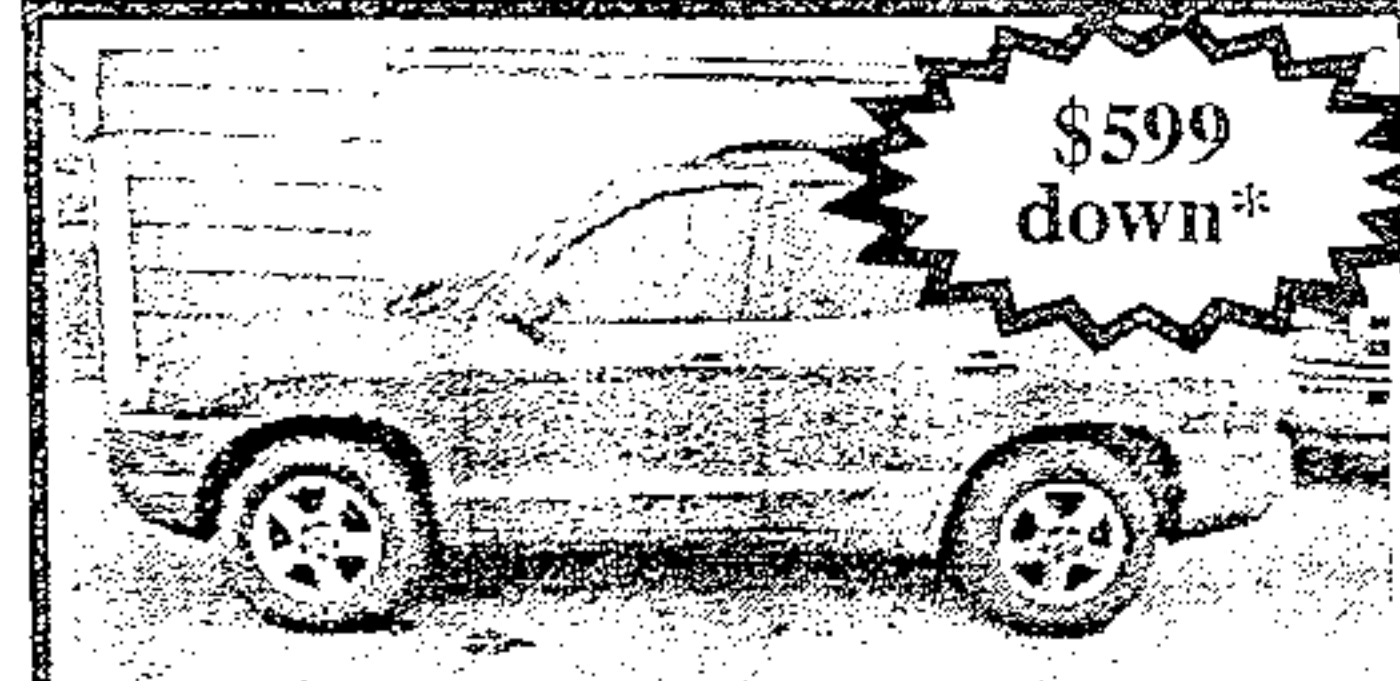

04 Santa Fe, auto, Nice, clean, Only \$599 down*

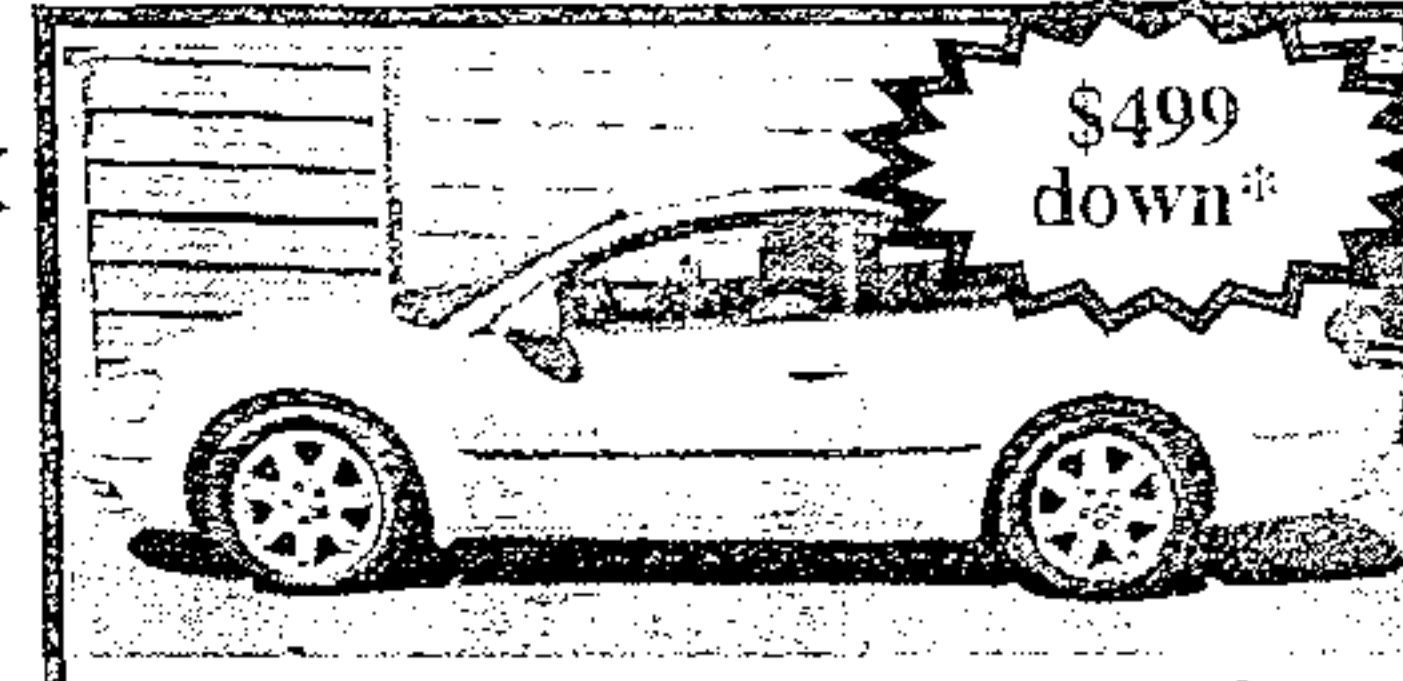

01 Sebring 2dr. sporty, Only \$499 down*

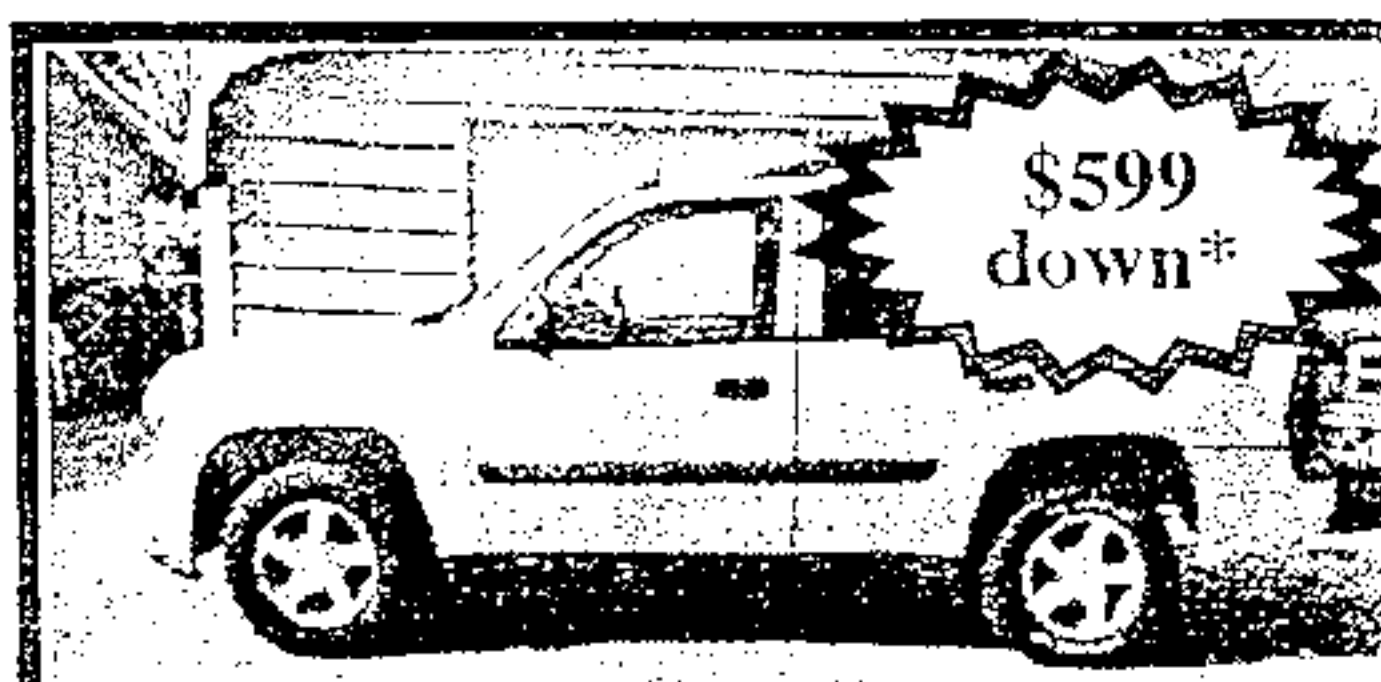

05 Trailblazer, auto, good miles Only \$599 down*

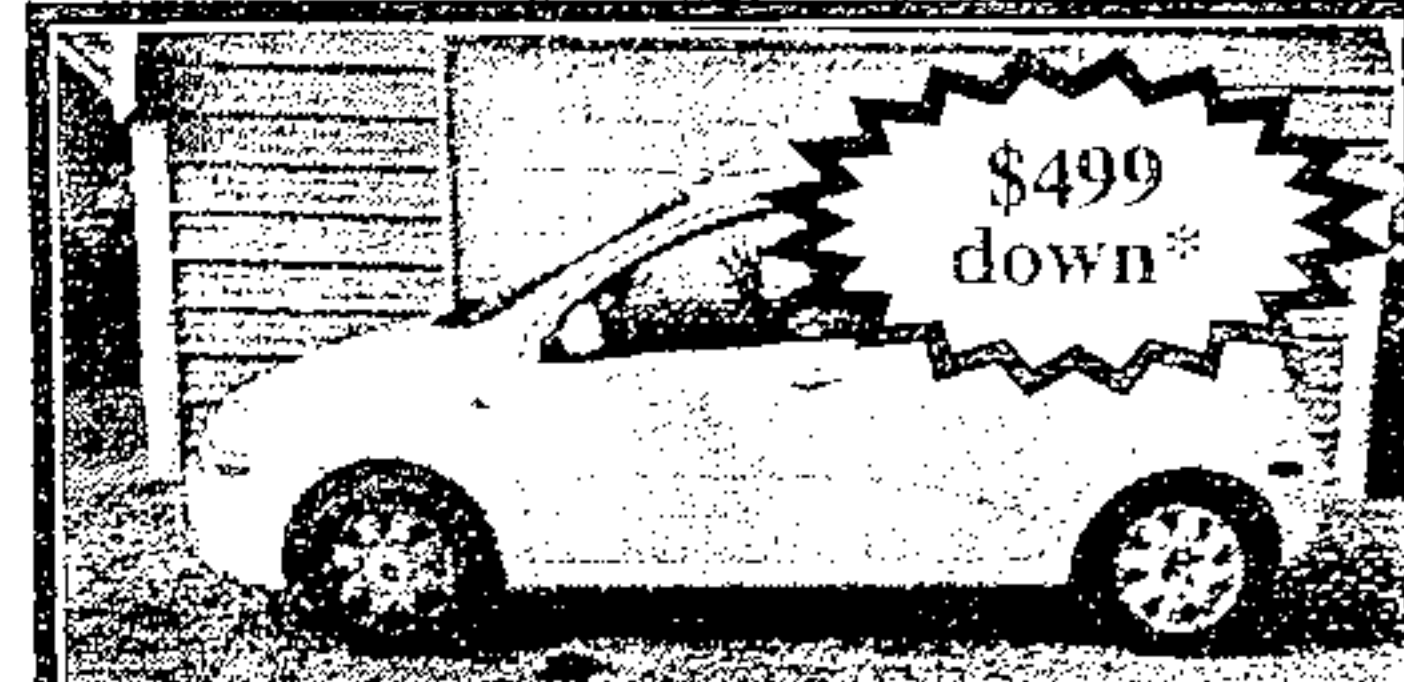

04 Aveo, auto, gas saver, Only \$499 down*

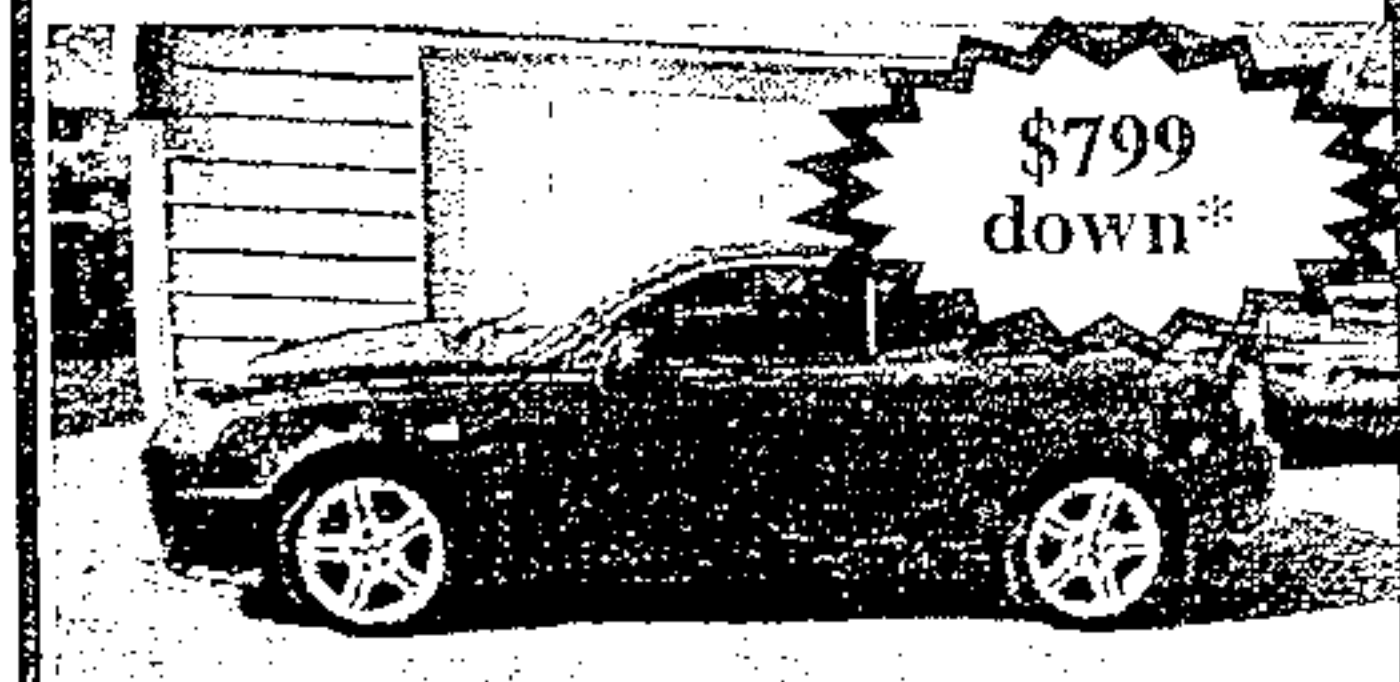

06 Tiburon GT, 5 speed, sporty, Only \$799 down*

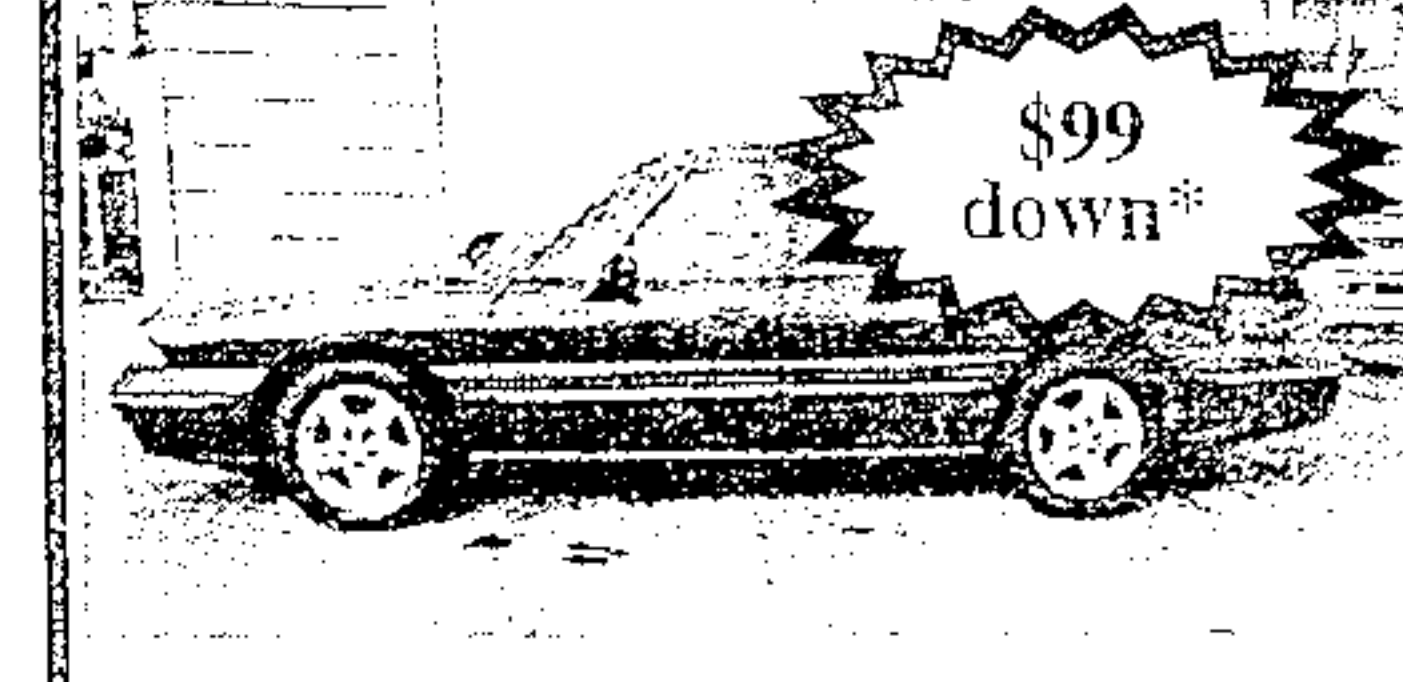

98 Bonneville, 6 cyl, Auto, low payments only \$99 down*

NO Credit Checks

Marty's Auto Sales
986-2222

Se Habla Espanol

100% Approval

*See Dealer for details. All down payments plus tax, tag, title and fees.

MARTY'S AUTO SALES • 986-2222 • MARTY'S AUTO SALES • 986-2222 • MARTY'S AUTO SALES • 986-2222 • MARTY'S AUTO SALES • 986-2222 • MARTY'S AUTO SALES •

FBI ctd. from pg. 7

the painting before going to the FBI office," said Janis Bobb. "For us, it was a no brainer. We knew it should go back to Warsaw."

Although the Bobbs had to bid farewell to the painting, the FBI invited them and Polish government officials to attend a rededication ceremony at

the National Museum in Warsaw last fall. There they were joined by Witmann and his wife, as well as Zukas, to witness Portrait of a Young Man officially returned to its rightful place.

"Seeing the painting unveiled and back at the museum was an incredible feeling. It was the single best moment in my FBI career," said Zukas.

THE RELIC SHOP

521 Hwy 321 Lenoir City Suite 3
next to Stained Inc and the Inn of Lenoir
865-250-9280

WE ARE IN TUCSON, ARIZONA BUYING UP FOSSILS FOR THE SHOP. WE NEED TO MAKE ROOM!!!

ALL AMETHYST 40% OFF

GREAT SELECTION OF ANCIENT MEGALADON SHARK TOOTH OVER 8 MILLION YEARS OLD

Is Your Washer Broken?

Call Me

I Only Charge \$100 Period!!!

Call Allen

865-617-7113

A Name You Already Know And Trust Just Got Even More Dependable
DEPENDABLE AUTO SERVICE, LUBE AND TIRES
is Now Offering
Expert, Affordable Transmission Service

All ASE Certified Technicians

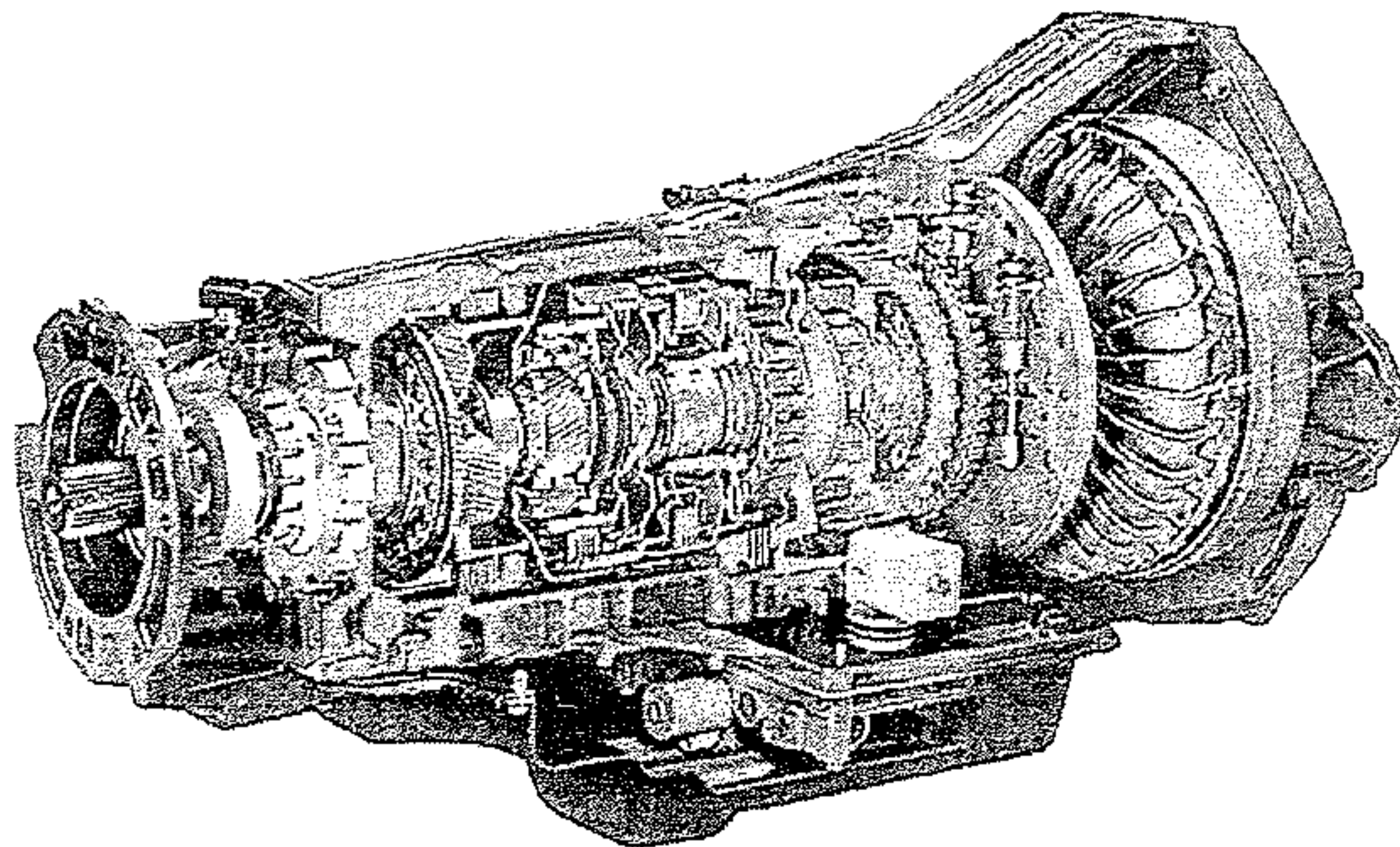

We proudly welcome all New Customers and Former Advanced Transmission Customers with a 10% Discount and Any Transmission Service or Repair*

865-986-9359

865-986-5050

Bad Credit, No Credit OK!!! We Finance Everybody!!!
Taxes Done Here!!! Bring your last pay stub or W2 and DRIVE TODAY!!!

Over 100 Cars, Trucks & Vans in Stock - Warranties On ALL Vehicles Sold!!!



2005 Ford Ranger, Super Nice Truck, Very Low Miles

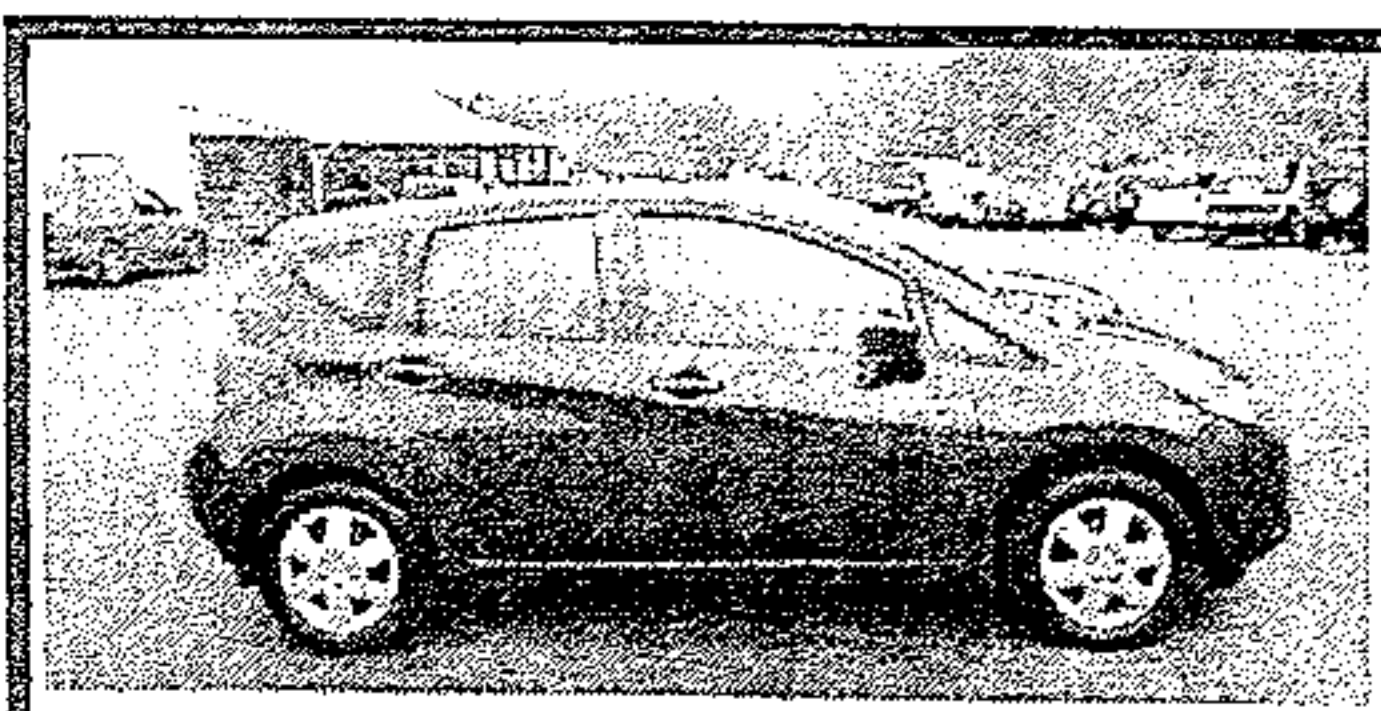

2015 Nissan Versa Note, Factory Warranty, Low Miles



2011 Kia Soul, 5 speed, 4 dr, Gas Saver, Nice & Clean



2008 Saturn VUE, LOADED!!! 4dr, Ready to go on a trip!

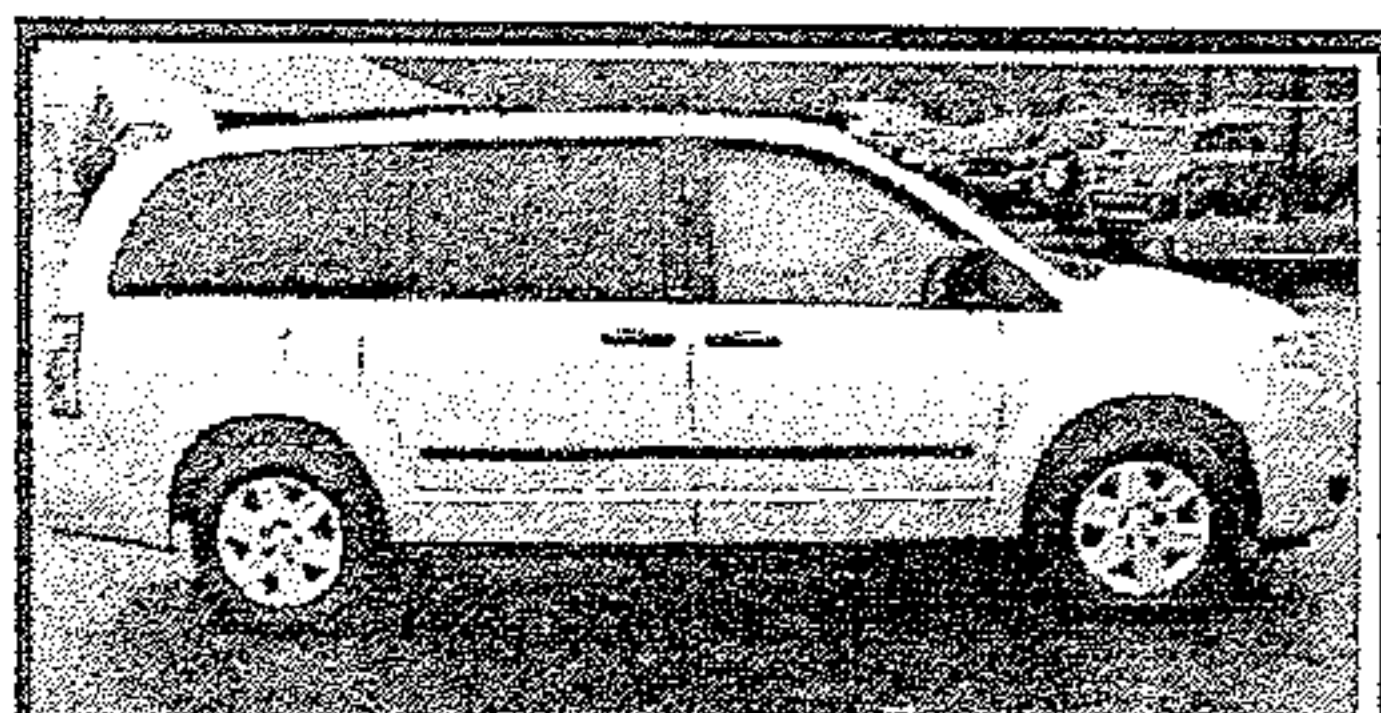

2008 Dodge Grand Caravan, Nice, Clean, Stow n Go!



2014 Chevy Sonic, Factory Warranty, Low Miles!



Mitsubishi Raider, Ext. Cab, Super Nice Truck



2013 Nissan Versa, Like New! LOADED!!!

WALT WILLIAMS, INC.

*with approved credit

3003 Highway 11 Lenoir City, TN **865-986-1111**