

The Daily Edition

50¢

Serving Loudon, Monroe and Surrounding Counties

Friday, March 4, 2016

Stolen car leads to more charges including burglary

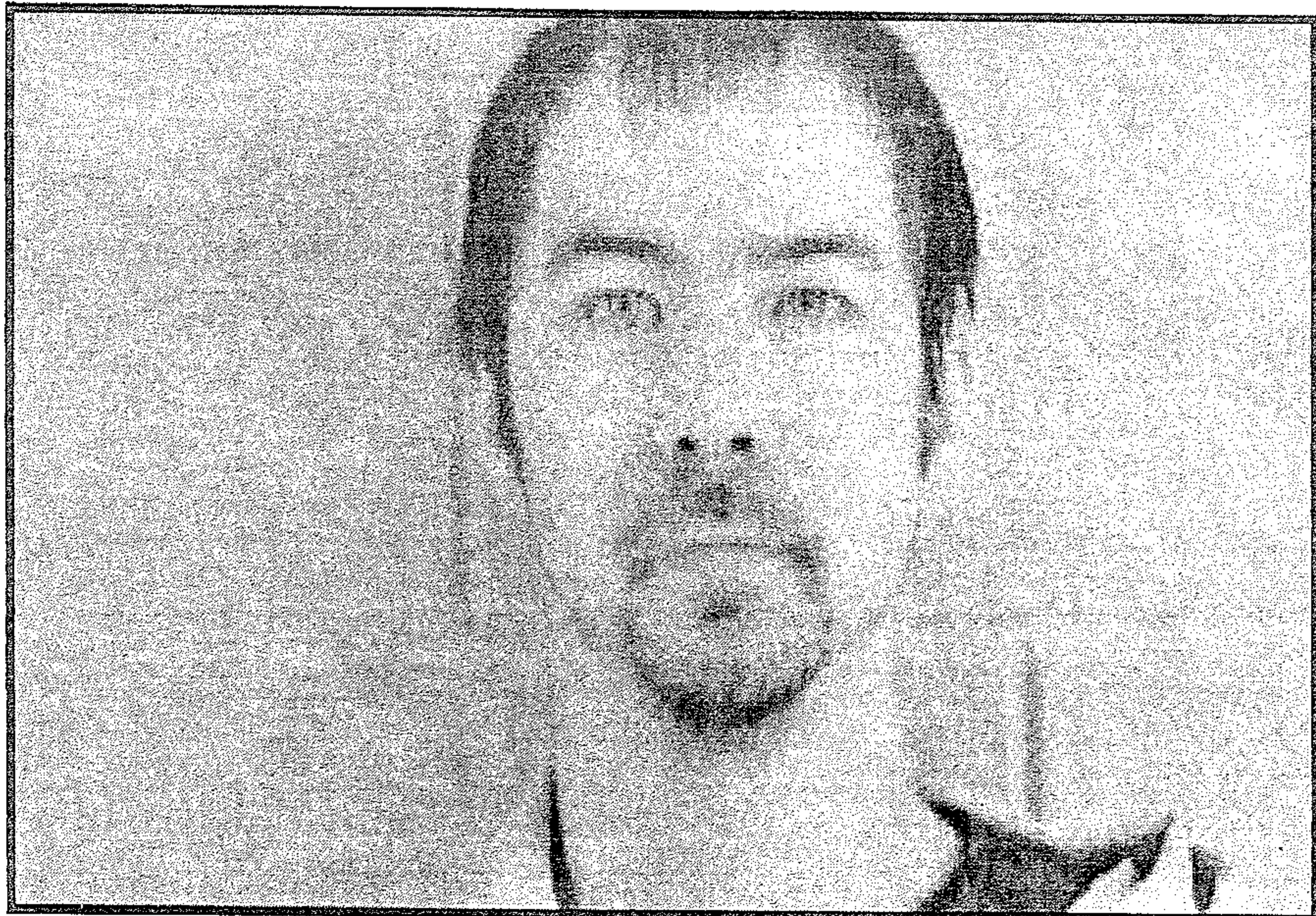

Brent Snyder

(see burglary pg. 2)

FBI Tip Line

Web Portal, Created in 2001, Receives 'Actionable' Tips Daily

In the pre-dawn hours of October 22, 2014, a New Hampshire man was browsing a popular Internet message board when he came across what appeared to be an anonymous threat: "I'm going to shoot up University of Louisville's Miller hall [sic] tomorrow at 10 a.m."

The man went to the FBI website and submitted a tip at 4:23 a.m. Eastern Time. "Some idiot is making threats," he wrote on tips.fbi.gov, and included a link to the suspicious post. Within a minute,

(see FBI pg. 7)

Haslam Announces Purkey's Return as Homeland Security Advisor

Has served two years in dual role as TEMA director, Homeland Security advisor

Tennessee Gov. Bill Haslam today announced Tennessee Emergency Management Agency (TEMA) Director David Purkey will return to the singular position of governor's Homeland Security advisor and assistant commissioner of the Department of Safety and Homeland Security (DSHS) after serving in dual roles at TEMA and DSHS for the

(see Haslam pg. 5)

DUI after weaving in front of deputy



Michael McCaslin (see DUI pg. 5)

Assault occurs over sex request

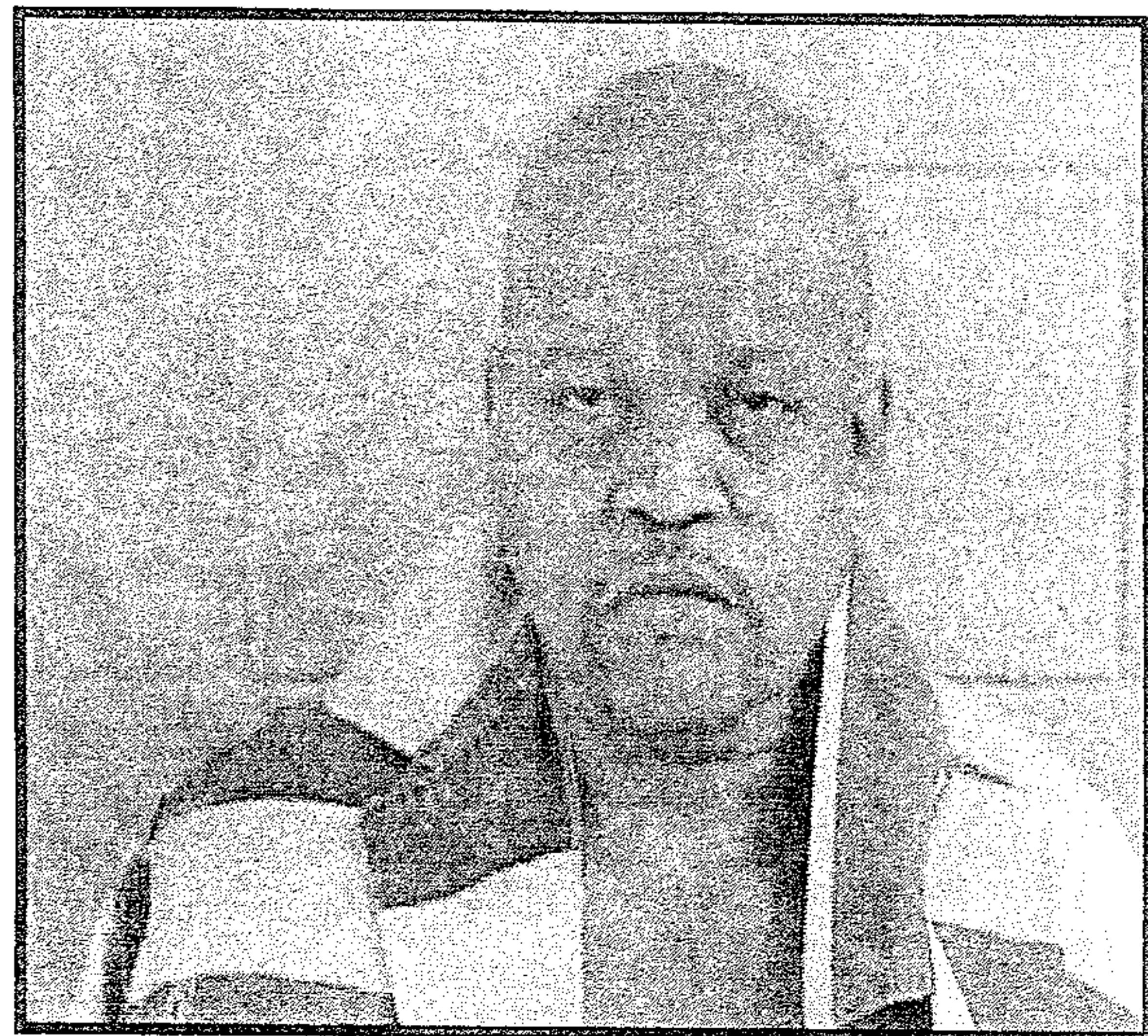

Vincent Thomas

(see DV pg. 3)

Verse of the Day

You are still worldly. For since there is jealousy and quarreling among you, are you not worldly? Are you not acting like mere humans? — 1 Corinthians 3:3

Obituaries

see inside

Wazzup

Looks like spring is upon us finally!. No wait, we still got more cold stuff coming! False alarm.

Weather

Today: Mainly cloudy. High 52F. Tonight: Partly cloudy. Low 33F. Saturday Sunny along with a few clouds. High 62F. Saturday Night Partly cloudy. Low near 35F. Sunday Mainly sunny. High around 60F.

Sunday Night A few clouds from time to time. Low 38F.

Horoscopes

Pisces 2/19-3/20

Avoid making any long-term decisions today because your thinking is so inconsistent that it's run-

(Continued on page 6)



burglary

Brent Snyder, 33, Caldwell Road Loudon, was charged with Aggravated Burglary, Theft of Property x2. On 2/26/16 victim reported Brent Snyder took her vehicle and did not return. The vehicle was entered into NCIC. Deputy Brad Rayfield LCSO,

spotted the vehicle on HWY 444 parked in front of a business located on Ritchie Road with no one in the vehicle. After talking with the workers they stated a male matching Brent description came in the business and went out the back door. K-9 was dispatched to the area during

(see burglary ctd. pg. 4)

Call 865-771-2249 to Advertise and start saving today!
Has your group got an event coming up?
Let us know!!!

To Get a Burning Permit:

Loudon (865) 986-8395
 Monroe (423) 442-7401
 Roane (865) 354-1054

Notice: The Daily Edition does not knowingly accept fraudulent or misleading materials. The Daily Edition cannot guarantee the validity of offerings or statements contained herein. All liability for the contents of all advertising, and for any claims that may arise therefrom, is the responsibility of the advertiser or its agency. The Daily Edition reserves the right to reject, edit, or abbreviate any advertisement submitted. Advertising is accepted with the understanding that all liability for all copyright violations is the sole responsibility of the advertiser. Photographs, artwork and other copy submitted for publication is considered the sole property of the advertiser. The Daily Edition will make every effort but will not be liable for failure to publish and ad or for typographical and layout errors. All statements and information about highlights featured items, letters to the editor, herein are those solely given to the interviewer or writer and the Daily Edition assumes no responsibility of the accuracy or validity thereof. The Daily Edition will gladly reprint at no charge that part of an advertisement in which an error occurs provided a claim is made within 3 days of the first publication of the ad. Information contained in the Wazzup is received anonymously and the Daily Edition assumes no responsibility for information and reserves the right to edit or reject any and/or all submissions. The Daily Edition is a daily newspaper of general circulation in Loudon County defined under TCA 2-1-104(a)(13). The Daily Edition also serves Monroe, Knox, Anderson, Roane and Blount counties and serves 30,000 readers weekly. Send mail to PO Box 1240, Lenoir City TN 37771. 865-771-2249. email: dan1204us@yahoo.com
 The Daily Edition is Loudon County's premier public interest and paid advertising paper. The Daily Edition is produced and published daily Monday through Friday and is circulated throughout Loudon County and parts of Monroe and Knox Counties. Display advertising rates \$5.00 per column inch and quantity discounts available. Call for information on upcoming promotions and events.

HACIENDA Ayala's
Mexican Restaurant
 Market Dr. * Lenoir City (In Front of Food City)

Real Authentic Mexican Food at Affordable Prices

BEST MARGARITA

You've Tried The Rest Now Come Have The Best!!!

We Accept ALL Competitors Coupons Outside of Mexico City!

986-3553



Good Credit OK • Bad Credit OK • Bankruptcies OK • Repo OK



2010 Kia Soul Sporty, 4 cyl, Auto, PW, PL, A/C, Great On Gas, Like New



2010 Ford Escape Limited Leather, Alloy Wheels, Heat, A/C, Luggage Rack, 79K,



2007 Dodge Ram 1500 Quad Cab, Thunder Road PKG, 20 in. Wheels, Low Miles, Hemi



2008 Ford Explorer 84k, 3rd Row Seating, Luggage Rack, Tow Pkg, PW, PL



2011 Ford Ranger Low Miles, Tow Pkg, New Tires, A/C, Heat, Bed Liner.



2011 Dodge Grand Caravan DVD, Stow & Go, Loaded, Remote Doors, Rear A/C

DEPENDABLE MOTORS 986-9343
803 E. Broadway • Lenoir City

* WAC. See Dealer for details

Visit our website at: www.dependablemotorslc.com

Serving Loudon County for 20 Years

DV
 Vincent Thomas, 45, Washington Pike Knoxville, was charged with Domestic Assault. Officer Bryan Blakney LPD, was dispatched to Creekwood Circle in refer-

ence to a physical domestic. Dispatch advised there was a male subject in the residence that had assaulted the female that resides at the residence, the male was trying to kick in the bedroom door to get the female. Upon arrival Officer Blakney, Houser, LPD, and Cpl. Branam LCSO, had made contact with the male identified as Vincent Thomas in the residence. Vincent stated that he had been pepper spray by the victim. After talking with the victim she stated that Vincent was intoxicated and trying to have

sex with her and he had been physical by slapping her in the face. Victim did have red marks on her face consistency with her statement.

Vincent did appear to be very intoxicated and disoriented. Vincent was placed under arrest. Officer Bryan Blakney LPD, made the arrest.

For Sale: oak Wood Mulch



Mushroom Compost Topsoil.



Firewood

Call Steve Spoon
 986-4282

The Daily Edition
 serving Loudon and surrounding counties since 1986

C&C Lawn Care
 Mowing, Mulching, Trimming, Edging, Clear Debris
 Free Estimates
 Call Chad 865-271-8070

West End Storage & Warehouses
 502 Ward Avenue • Loudon
 Call 865-458-4774 or 865-679-5555

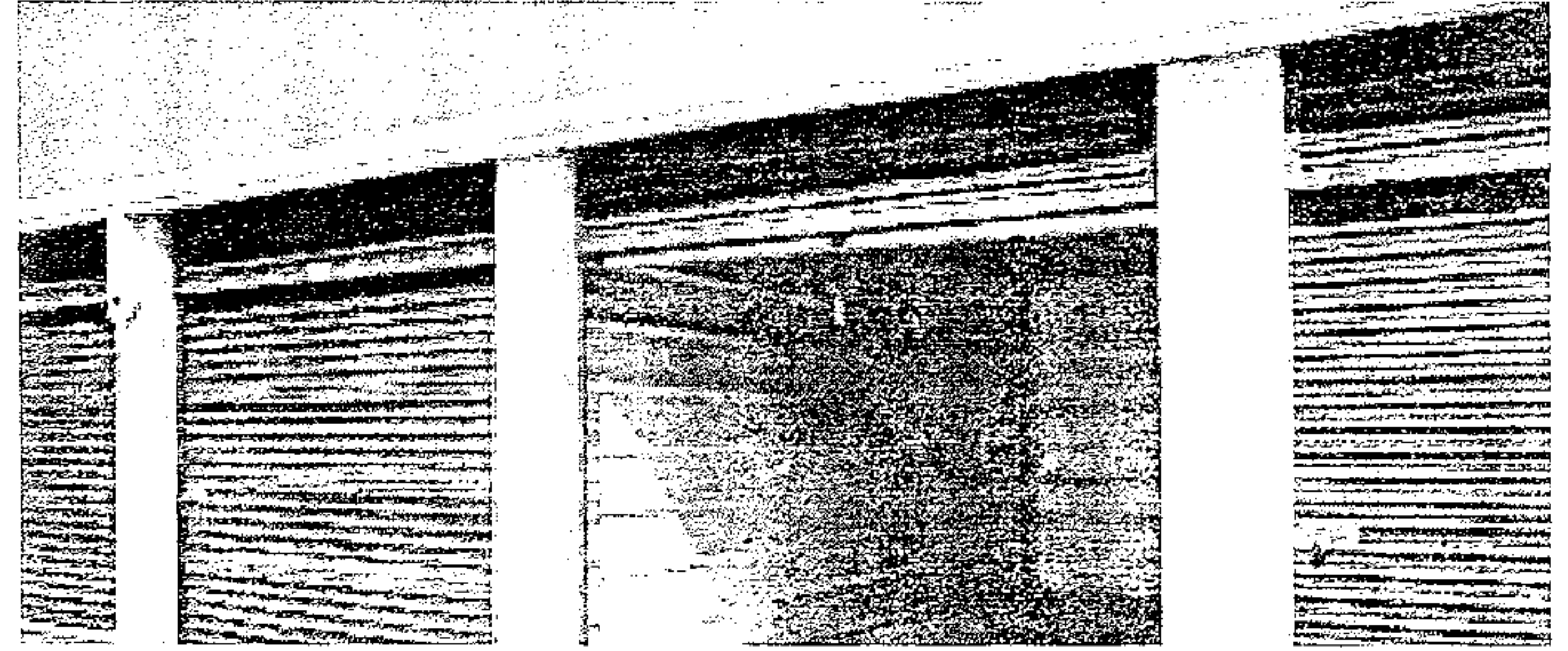

STAINED INK
TATTOO & PIERCING
 LENOIR CITY 865 816-6440
 NEW OWNER • NEW ARTIST • SINCE 2011
 521 Hwy 321 next to Vape & Stuff & Inn Of Lenoir!
 Clean-Affordable-Quality-Custom
 Tattoo's You've Always Wanted!

BRING IN THIS Ad FOR **\$25 OFF**
 NEW INK FOR NEW CUSTOMERS ONLY!

Check us out on FB.com/
 Stained.Ink.Tattoo/
 www.STAINEDINC.com

C&J Towing and Recovery
 LOWEST TOWING RATES AROUND!!!

Have you been overcharged for any type of towing service in the Lenoir City area? If you have a breakdown or accident please OWNER REQUEST C&J Towing with the officer. Also please call your Sheriff and ask him to place C&J Towing on the "Rotation List*" and help other motorists save as much as you did! We at C&J are locally owned and operated, State approved, licensed, bonded and insured. Call and let us know if your denied service or how we can be of assistance.

*note: the "Rotation List" is a list of wrecker services that provide service for wrecks, DUI's, breakdowns, etc. and are on an on-call basis for service. This list is approved by the Sheriff.

Cliff Teeters • Owner
 865-809-1661



BIMBO'S
 Deli Open 24 Hours
 865-986-9643 Call Ins Welcome

Specials

Lg. Cold Sub, bag of chips and 16 oz. fountain drink
 only \$6.29

Footlong Corn Dog \$2.59

burglary ctd. from pg. 2 tracking Brent was spotted hiding behind a brick house located on Cemetery Road. Brent was apprehended and had two red insulated cups in his possession. Approx. one hundred yards of the residence.

After an investigation the back door to the residence was

found forced open with a muddy shoe print on the door. The home owner identified the cups Brent had in his possession to be his that was previous inside the home.

Victim did not give anyone permission to enter his home. Deputy Cody Fritts LCSO, transported Brent to the Jail.

Help Wanted

Experienced Dispatcher Needed At Moneymaker Wrecker Service

Apply in person at 11776 Hwy 70, Lenoir City

BUDGET Transmissions

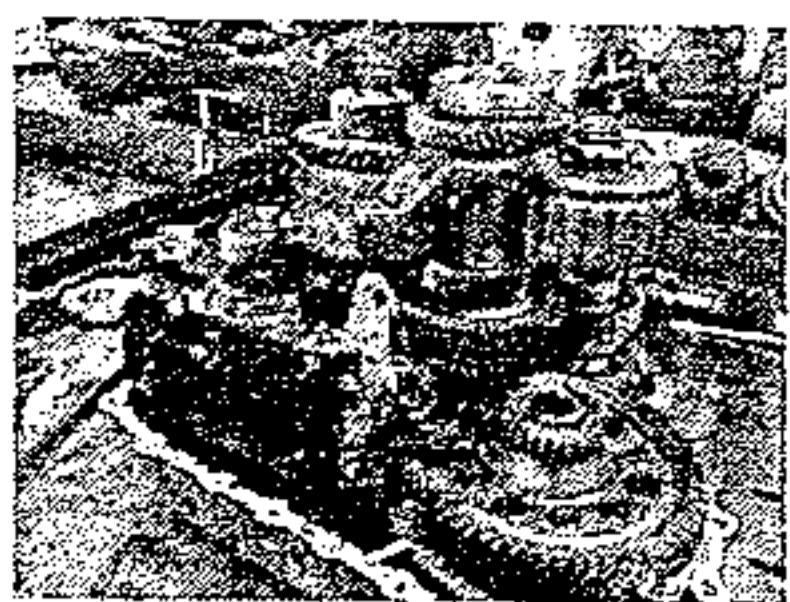

302 S. Northshore Drive Knoxville

(865) 584-4391 budget-transmissions.com

Why Buy From Budget?

Free Towing From Lenoir City or Loudon County

20 Years of BBB Zero Customer Complaints Award Member

A+ Plus Rated

Huge Transmission Inventory

Best Technicians Period!!!

Call (865) 584-4391 Today!



Approved Auto Repair



NEED HELP WITH INCOME TAX? PROFESSIONAL TAX SERVICE

PRICE - 95% of returns between \$60-\$140

(No Coupons Required)

LOCALLY Owned & Operated - Open Year Round

30+ Years in the business

ALL Preparers with 10+ years experience

Pro Tax

111 E. Broadway

Lenoir City, TN 37771

Phone 865-986-4035

**US Armed Service Active Duty Personnel, "THANK YOU", Tax Return Free*

good to know you™

IMMEDIATE OPENINGS!

Randstad is NOW HIRING for 2nd shift Assembly Positions at Commercial Vehicle Group. These are long-term, temp-to-hire positions!

Hours: 4:30pm - 3:30am (end times vary)

Pay: \$10/\$10.50 per hour

You may apply by visiting our Facebook page www.facebook.com/vonorejob and clicking the "Sign Up" button. You can also get a paper application from the Guard Shack at 200 National Drive, Vonore, TN 37885.

For questions, call 423.884.4733

www.randstadstaffing.com

EOE



Staffing | Professionals | Search & Placement | HR Solutions | Inhouse Services

DUI

Michael McCaslin, 41, Dunn Road Tellico Plains, was charged with DUI, and Violation of Implied Consent.

Timothy Webb, 38, East Athens Street Englewood, was charged with DUI by Consent.

Deputy Robbie Lane LCSO, observed a black vehicle sitting at the stop sign at Wood

Lawn and Buttermilk Road for some time while Deputy was behind the vehicle. The vehicle turned left and crossed over the center line and the fog line. Deputy attempted a traffic stop with the vehicle on Buttermilk Road at William Ferry, but the vehicle continued and attempted to pull in a driveway but was unable to pull all the way in. Depu-

ty made contact with the driver identified as Michael McCaslin who had a strong odor of alcoholic beverage coming from inside the vehicle. Deputy ask Michael to exit the vehicle, Michael was unsteady on his feet and had a strong odor of alcohol about his person. Michael perform poorly on sobriety test and placed under arrest. Deputy then made

contact with the passenger Timothy Webb,



Timothy Webb

who had a strong odor of alcohol coming from his person, red watery eyes, and slurred speech. Timothy stated the vehicle was his, and let Michael drive. Timothy was arrest for DUI by Consent. Deputy Robbie Lane LCSO, made the arrest.

Haslam

past two years.

“David has capably served Tennesseans in these two capacities for the past two years, guiding TEMA’s response to devastating storms and their lasting effects as well as Homeland Security’s collaborative effort with local and federal law enforcement in the wake of the Chattanooga attack last July,” Haslam said. “Both roles are intense 24 hour-a-day efforts. His focus on cooperation has been critical in these two areas. I look forward to him bringing his extensive experience and focus to Homeland Security.”

Purkey will continue in the both roles until the next director of TEMA is named. A nationwide search is currently underway.

“It has been a privilege to serve with the employees at TEMA who tirelessly work behind the scenes to help Tennesseans prepare for and respond to emergency situations. I look forward to a continued partnership as I shift back into a full-time homeland security role,” Purkey said.

“The requirements for both jobs are tremendous in these days of increased global threats, and we hate to lose him in this department because he has done an outstanding job leading the day-to-day operations of TEMA,” Major General (see Haslam ctd. pg. 7)

PURDY'S AUTO PARTS AND SALVAGE
WE BUY SCRAP IRON • COPPER • BRASS • ALUMINUM

\$ **Paying Top \$\$\$**
Call For Latest Prices

You Name It, We Buy It!

Radiators, Wheels, Batteries, Appliances, Farm Equipment

Copper
Paying Top \$\$\$
Call For Latest Prices

Complete Cars
per 100 lbs.

Scrap Metal
Paying Top \$\$\$
Call For Latest Prices
per 100 lb

We Buy Batteries

Aluminum Cans
Paying Top \$\$\$
Call For Latest Prices

Now Selling
Aftermarket
Body Parts at
Discount Prices

You Call We Haul!
423-519-5402

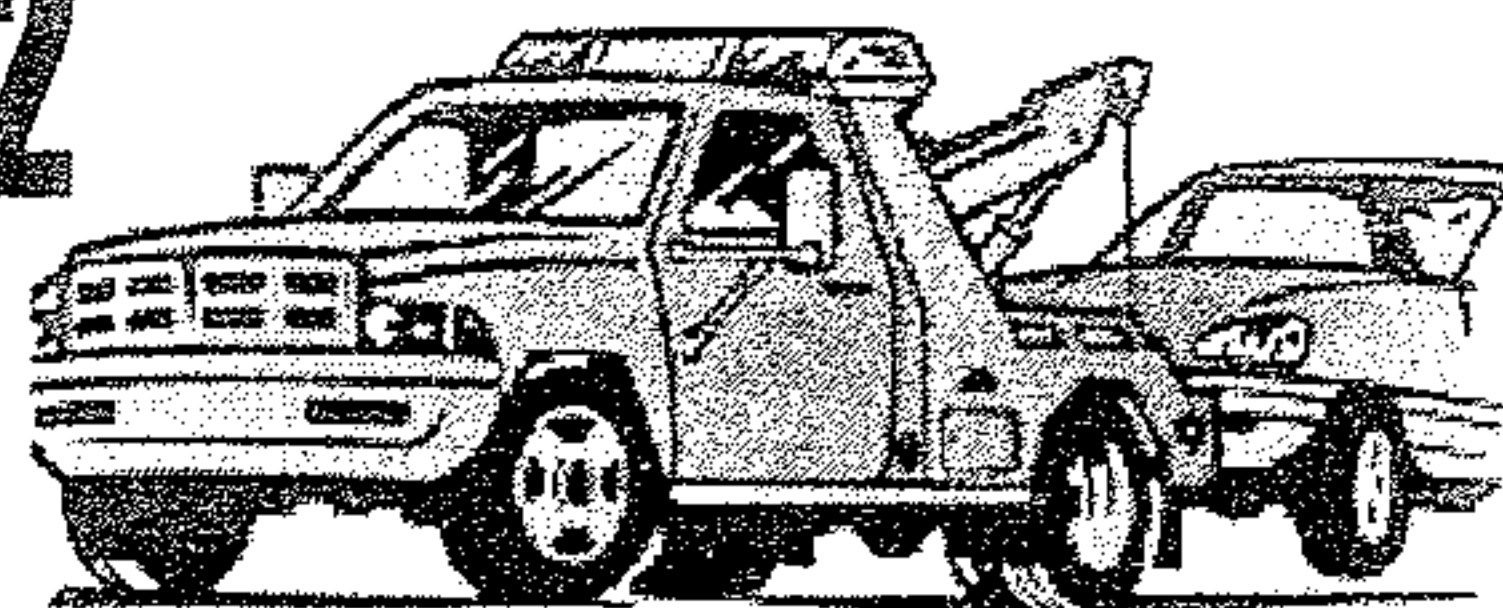

* Prices subject to change with the market.

423 337-3977
149 County Road 323 Sweetwater

* Prices subject to change with the market.

audit

an FBI agent in the unit that administers the FBI's global tip line picked up the tip, setting in motion a process that happens on average 1,300 times a day. Several analysts assessed the tip and deemed it credible. The unit's supervisory special agent immediately called the university's campus police as well as local police. They were on the scene by 8 o'clock that morning and quickly arrested an 18-year-old student suspected of posting the threat.

The case illustrates how a tip—no matter how cryptic, innocuous, or far-fetched the information may seem—can help prevent violent acts. Tips to the FBI have led to captures of Top Ten fugitives and short-circuited scores of crimi-

nal and terrorist plots. Established in 2001 in the wake of the 9/11 terrorist attacks, the tip line receives about 100 "actionable" tips every day related to possible criminal, cyber, terrorism, and espionage acts. Since its inception, the public has submitted more than four million tips via the Internet at tips.fbi.gov. In addition, phone calls to FBI field offices result in thousands of pieces of reporting a day.

"We will check them all," said William Dayhoff, head of the tips unit, which is staffed around the clock by about two-dozen Bureau employ-

ees. In most cases, after tips are assessed they are routed to FBI field offices and local law enforcement agencies for follow-up.

Intensified efforts by foreign extremist groups to radicalize individuals in the U.S.—and recent arrests of individuals apparently heeding their call—raise the necessity for the public to send tips or contact their local field office when something looks awry.

"We don't want to wait for an incident," said Jane Rhodes-Wolfe, of the FBI's Counterterrorism Division. "The whole push is for us to identify the next shooter or the next bomber who goes from troubled thoughts to evil deeds."

Dayhoff said the public shouldn't worry about whether a tip contains good or bad informa-

tion. The most helpful tips, however, contain context—the more information, the better. Sometimes it's like a mosaic, with different pieces coming from different places. In the case of the Louisville school threat, the tip was submitted by an individual nearly 1,000 miles away. In the 48 hours after the Boston Marathon bombing in 2013, more than 50,000 tips were submitted to the FBI, half of those through tips.fbi.gov. "It's our job to put the pieces together," Dayhoff said.

Some of the most valuable tips come from people closest to subjects—people who can see changes in mood and habits and can make a common-sense assessment that things aren't right.

Rhodes-Wolfe said she understands that it can be

a very hard decision for someone to contact the FBI. "We don't take that lightly," she said. "But this is a way you can help family members or friends, and potentially save lives."

Haslam ctd. from pg. 5

Max Haston, commissioner of the Department of Military, said.

"David is one of the most highly regarded state homeland security advisors in our nation. I value his advice and look forward to having him back full time to concentrate on the homeland security threats facing our state," Safety and Homeland Security Commissioner Bill Gibbons said.

Purkey is a native of Hamblen County with more than 35 years of experience in state and local

(see Haslam conc. pg. 8)

Help Wanted

Position Available Immediately! Apply in person at the Kenjo Marathon on Hwy 321 in Lenoir City.

LOOK! \$75 Weekly Payments LOOK!

MARTY'S AUTO SALES • 986-2222 • MARTY'S AUTO SALES • 986-2222 • MARTY'S AUTO SALES • 986-2222 • MARTY'S AUTO SALES • 986-2222 • MARTY'S AUTO SALES •

Bad Credit
Divorce
Fixed Income
Repos
Bankruptcy
No Credit

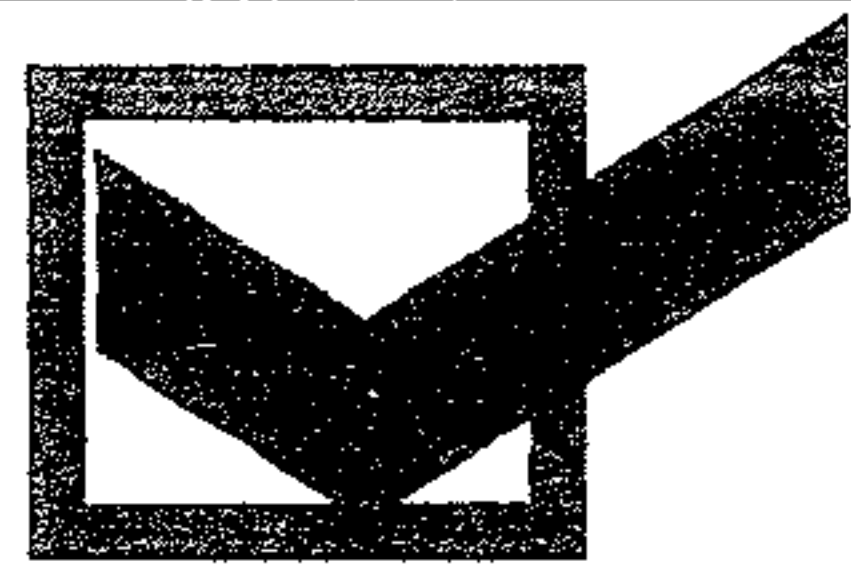

APPROVED!

NO CREDIT CHECKS

Visit Us On The Web At: martysautosales.net

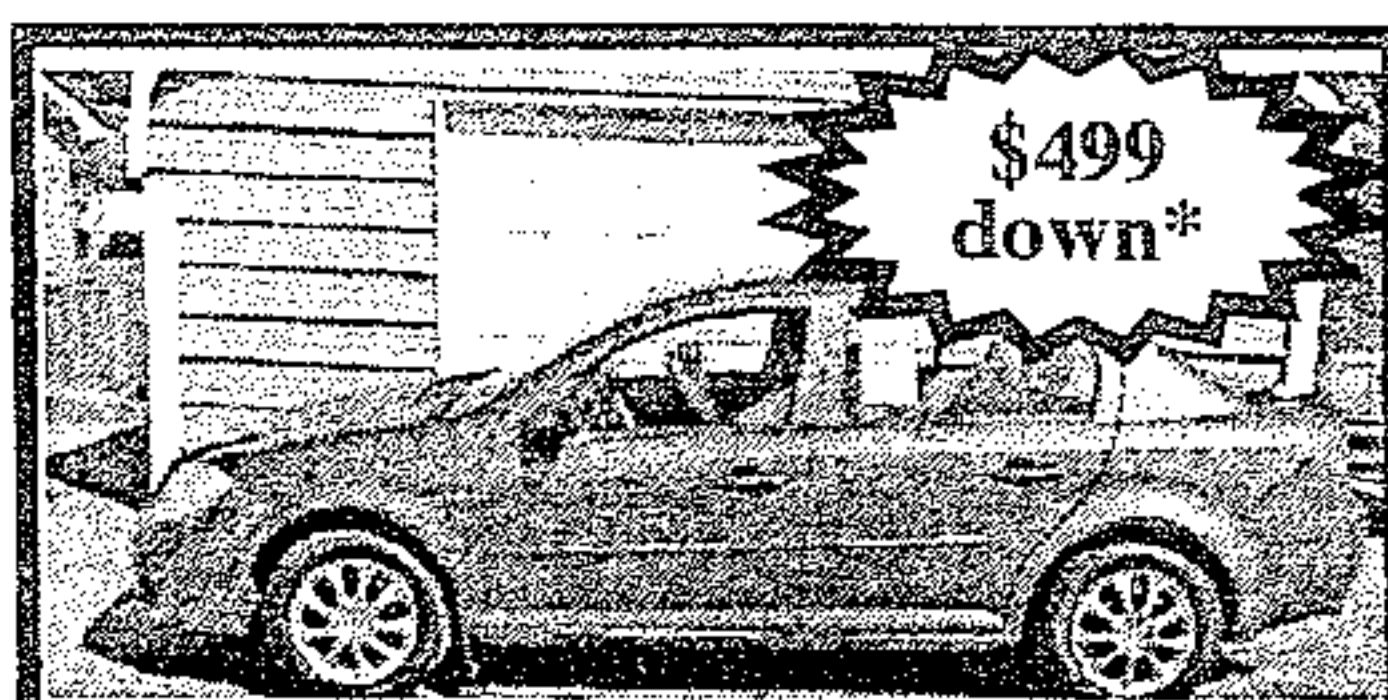

\$499 down*

07 Cobalt, 5spd, gas saver, runs great Only \$499 down *

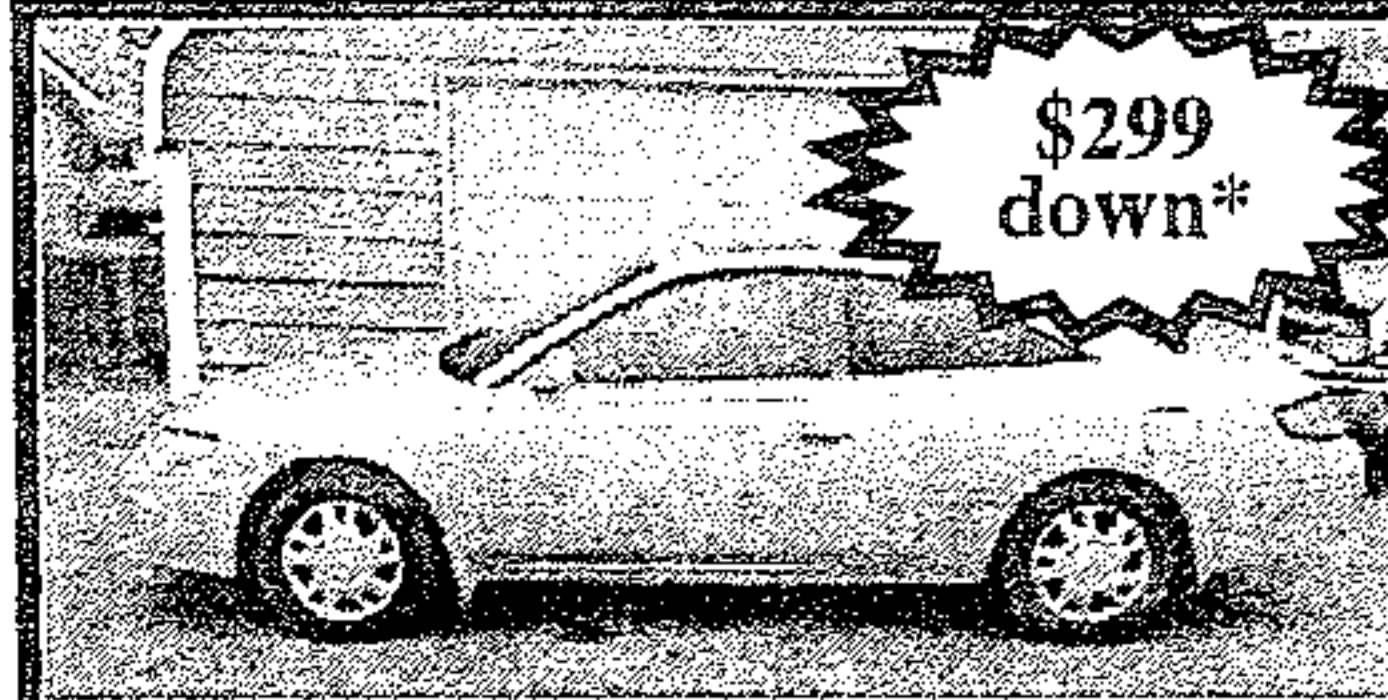

\$299 down*

99 Solara, V6, auto, sporty, Only \$299 down *

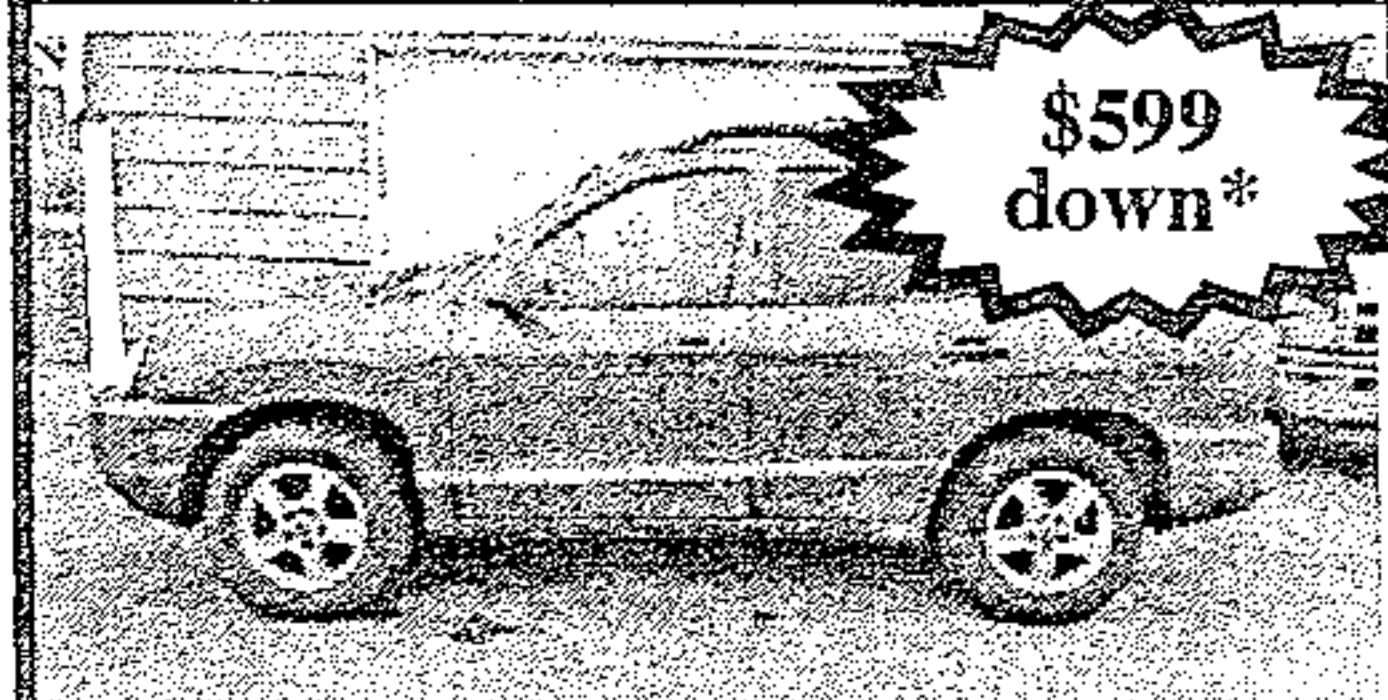

\$599 down*

04 Santa Fe, auto, Nice, clean. Only \$599 down *

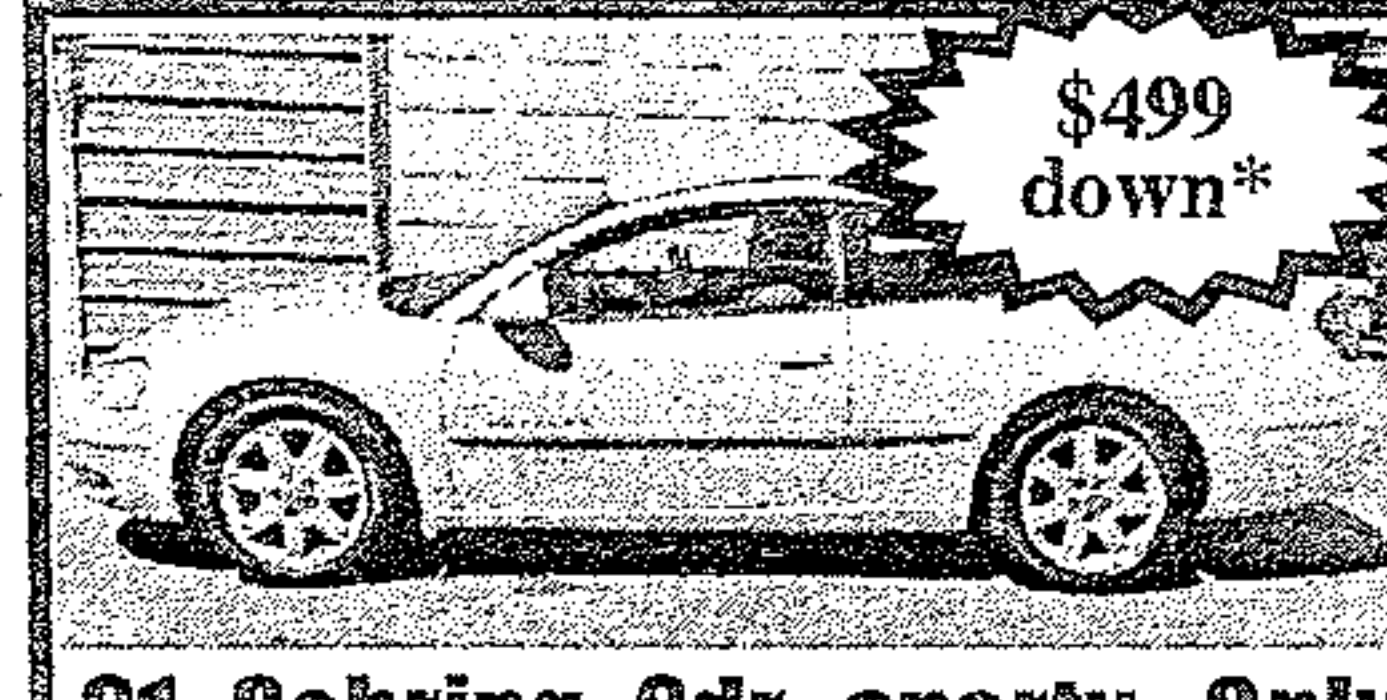

\$499 down*

01 Sebring 2dr. sporty, Only \$499 down *



\$599 down*

05 Trailblazer, auto, good miles Only \$599 down *



\$499 down*

04 Aveo, auto, gas saver, Only \$499 down *



\$799 down*

06 Tiburon GT, 5 speed, sporty. Only \$799 down *

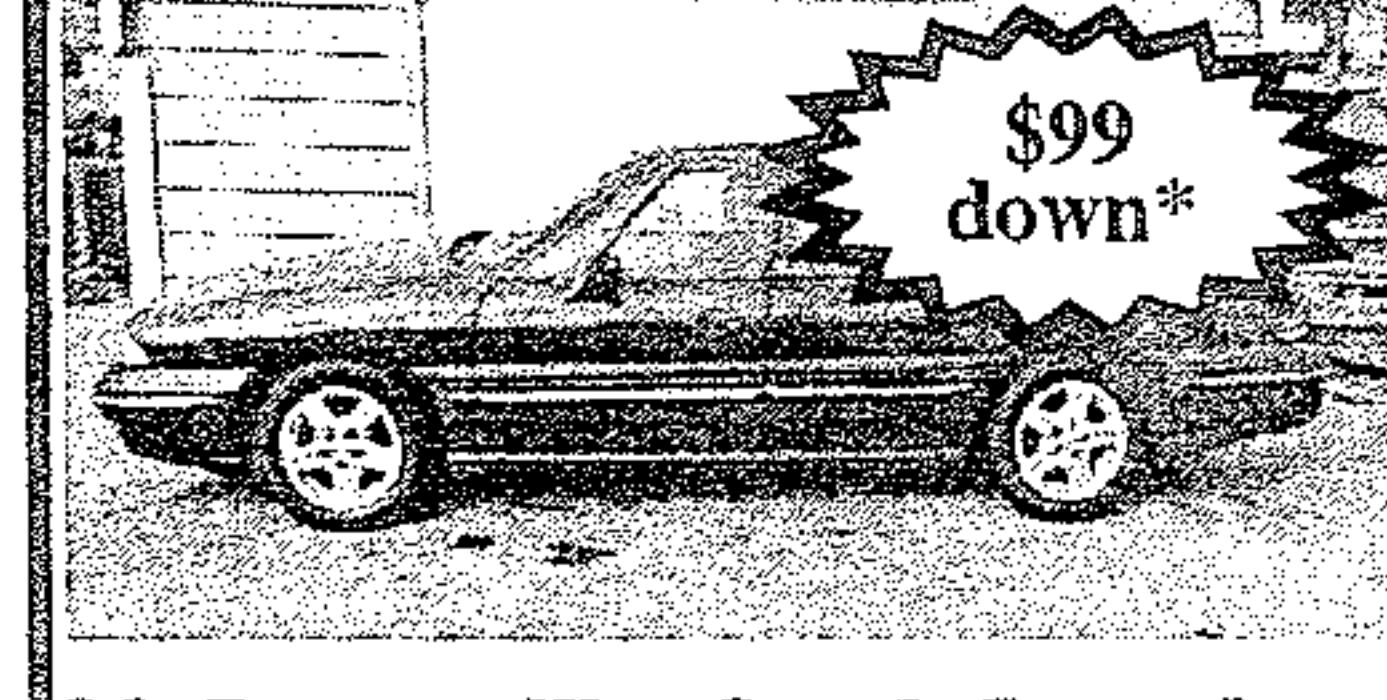

\$99 down*

98 Bonneville, 6 cyl, Auto, low payments only \$99 down *

NO Credit Checks

Marty's Auto Sales
986-2222

Se Habla Espanol

100% Approval*

MARTY'S AUTO SALES • 986-2222 • MARTY'S AUTO SALES • 986-2222 • MARTY'S AUTO SALES • 986-2222 • MARTY'S AUTO SALES • 986-2222 • MARTY'S AUTO SALES •

*See Dealer for details. All down payments plus tax, tag, title and fees.

Haslam ctd. from pg. 7
 government and emergency management, including service as county emergency management director, Tennessee state trooper, Tennessee Bureau of Investigation special agent, and mayor of Hamblen County. He served in the Tennessee

Army National Guard and United States Army Reserves. Purkey earned his bachelor's degree in Public Health from East Tennessee State University and master's degree in Public Health from the University of Tennessee.
 - See more at: <https://www.tn.gov/news/38012#sthash.VpOhqhAh.dpuf>

THE RELIC SHOP

521 Hwy 321 Lenoir City Suite 3
 next to Stained Inc and the Inn of Lenoir
865-250-9280

WE ARE IN TUCSON, ARIZONA BUYING UP FOSSILS FOR THE SHOP. WE NEED TO MAKE ROOM!!!
ALL AMETHYST 40% OFF
 GREAT SELECTION OF ANCIENT MEGALADON SHARK TOOTH OVER 8 MILLION YEARS OLD

Is Your Washer Broken?

Call Me
 I Only Charge \$100 Period!!!
 Call Allen
865-617-7113

A Name You Already Know And Trust Just Got Even More Dependable
DEPENDABLE AUTO SERVICE, LUBE AND TIRES
is Now Offering
Expert, Affordable Transmission Service

All ASE Certified Technicians

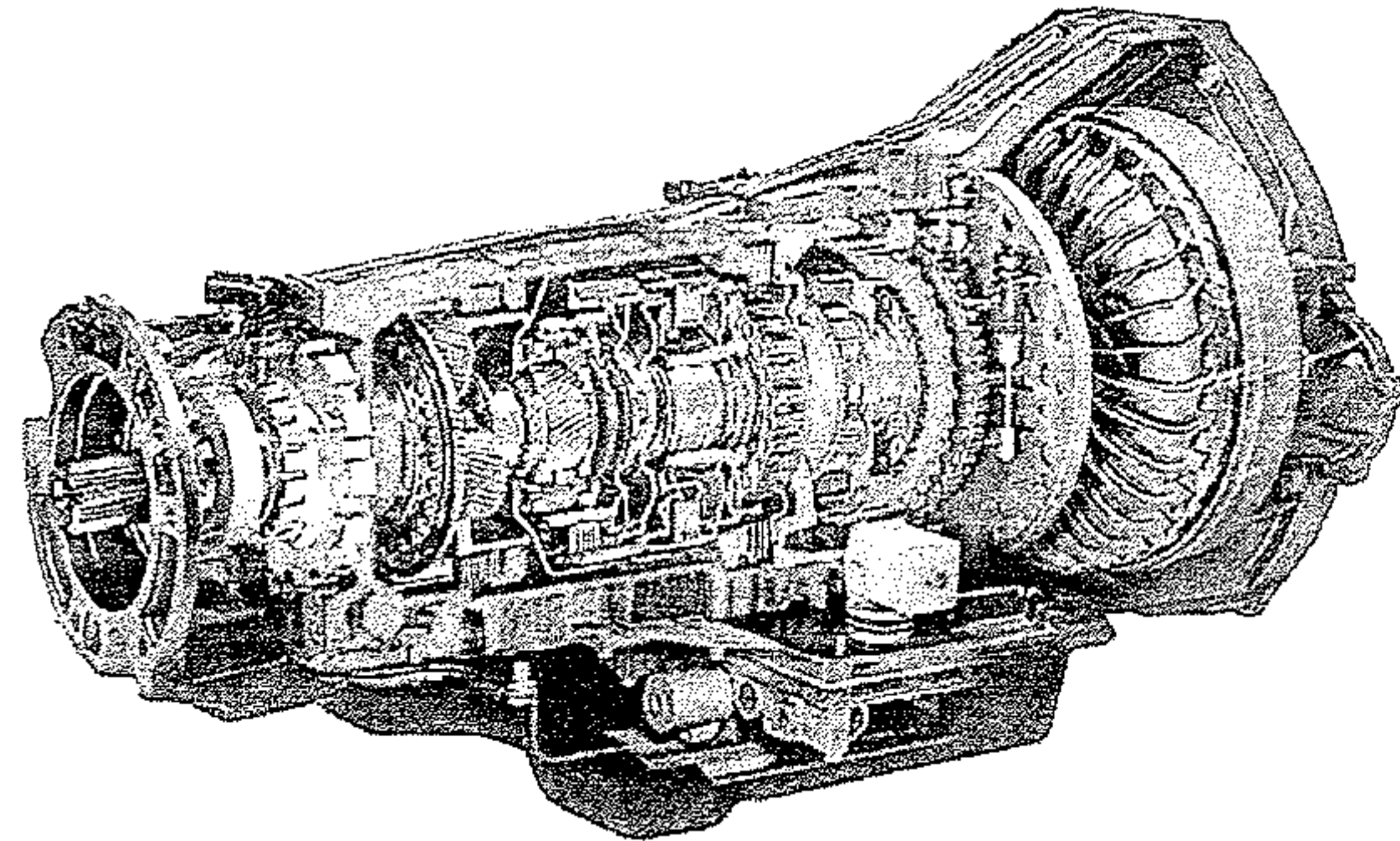

We proudly welcome all New Customers and Former Advanced Transmission Customers with a 10% Discount and Any Transmission Service or Repair*

865-986-9359

865-986-5050

Bad Credit, No Credit OK!!! We Finance Everybody!!!
Taxes Done Here!!! Bring your last pay stub or W2 and DRIVE TODAY!!!

Over 100 Cars, Trucks & Vans in Stock - Warranties On ALL Vehicles Sold!!!



2005 Ford Ranger, Super Nice Truck, Very Low Miles

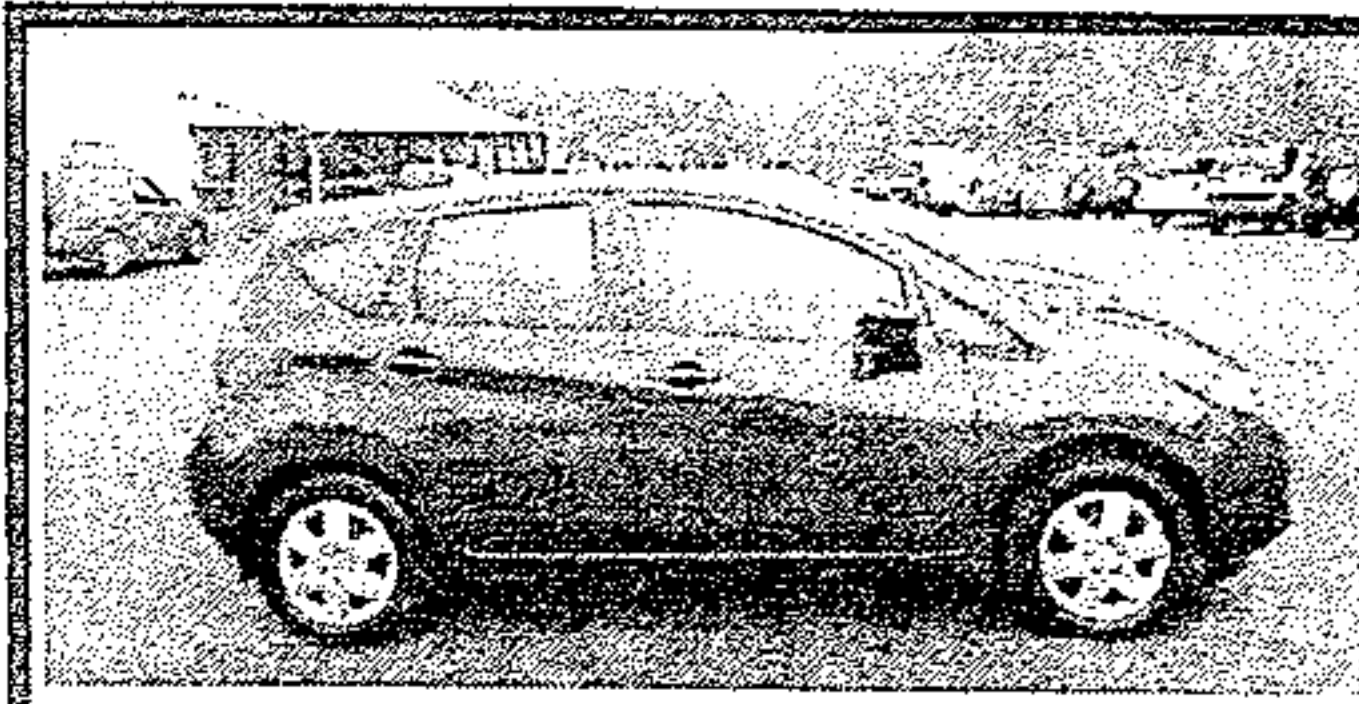

2015 Nissan Versa Note, Factory Warranty, Low Miles

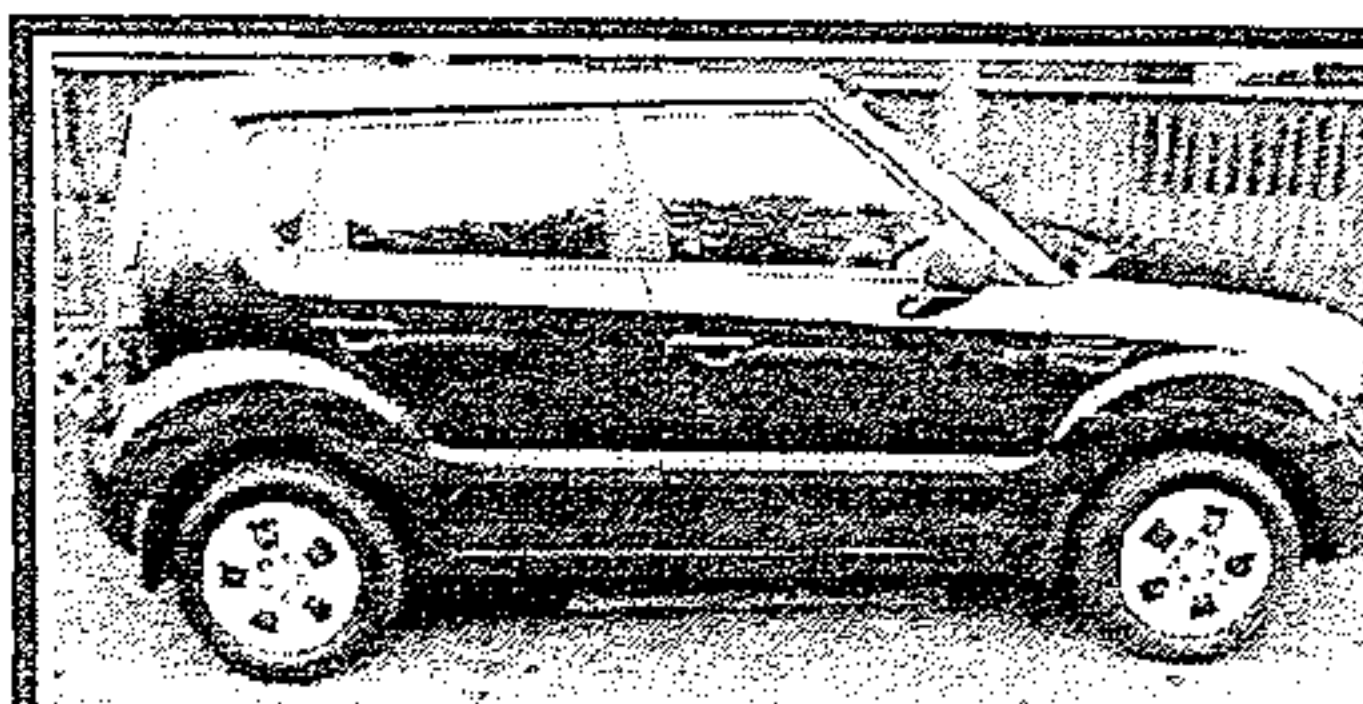

2011 Kia Soul, 5 speed, 4 dr, Gas Saver, Nice & Clean



2008 Saturn VUE, LOADED!!! 4dr, Ready to go on a trip!

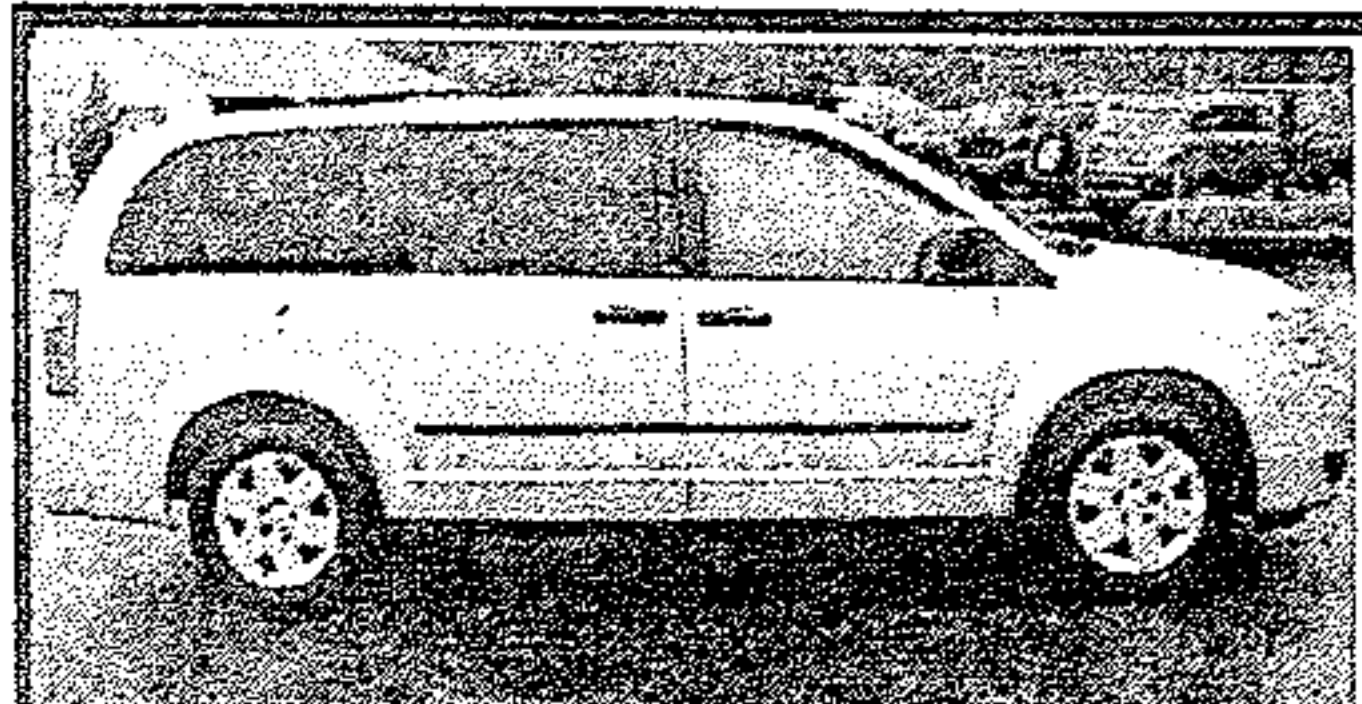

2008 Dodge Grand Caravan, Nice, Clean, Stow n Go!

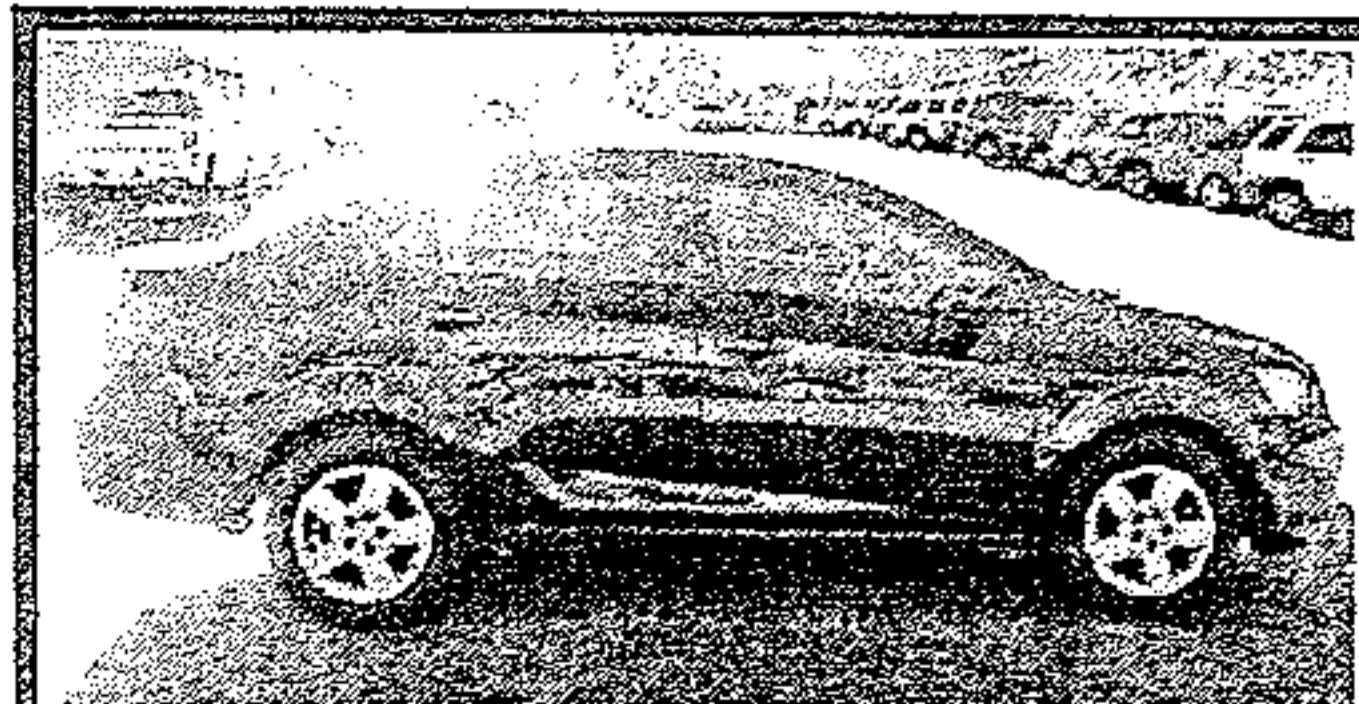

2014 Chevy Sonic, Factory Warranty, Low Miles!



Mitsubishi Raider, Ext. Cab, Super Nice Truck

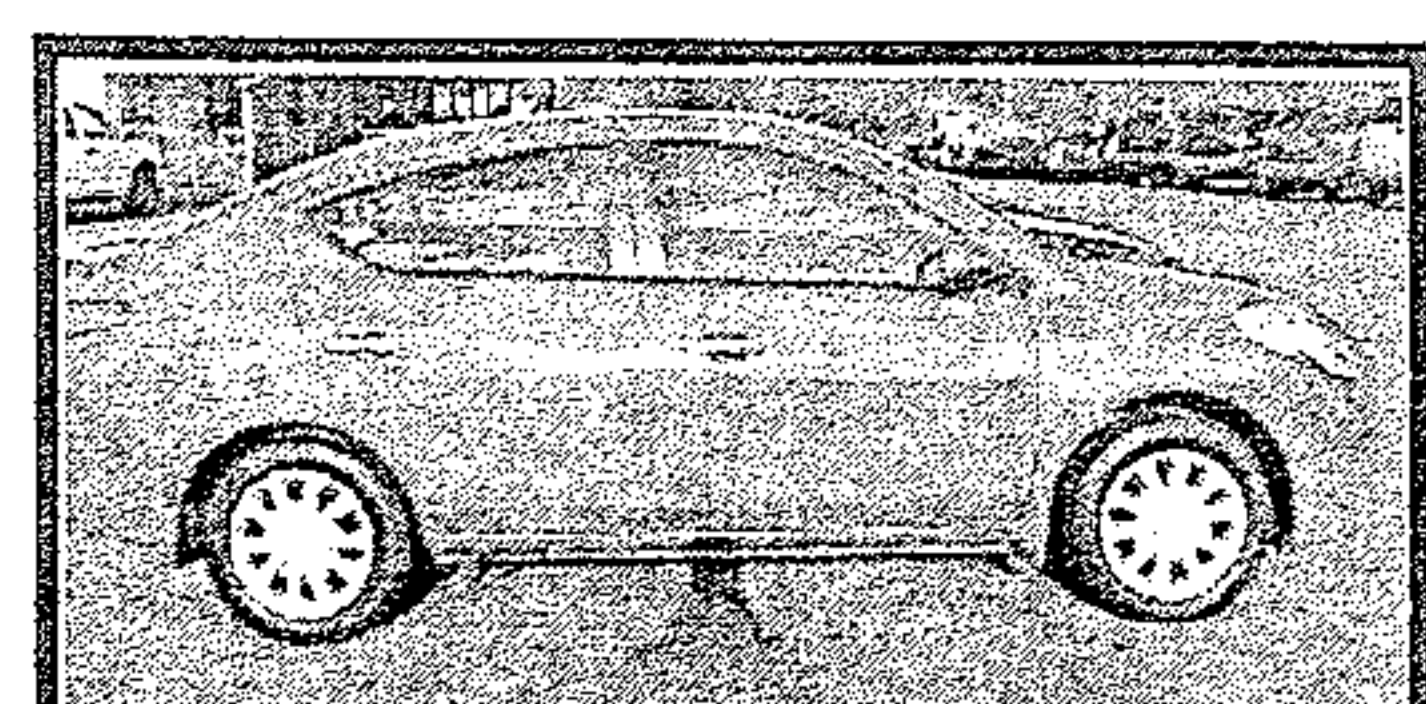

2013 Nissan Versa, Like New! LOADED!!!

WALT WILLIAMS, INC.

*with approved credit
 3003 Highway 11 Lenoir City, TN **865-986-1111**