

The Daily Edition

50¢

Serving Loudon, Monroe and Surrounding Counties

Thursday, March 24, 2016

Multiple officers respond to prowler call; Meth arrest made

Loudon County Deputies received a call of a prowler in the Beals Chapel Area and upon responding found several subjects with stories that didn't match up or make sense. Following the stop meth was found as well.

Michael Redmond, 46, O Street Lenoir City, was charged with Man/Sell/Del/, Resale SCH. II. Deputy Kenneth Palmer LCSO, was dispatched to a
(see LCSO pg. 2)

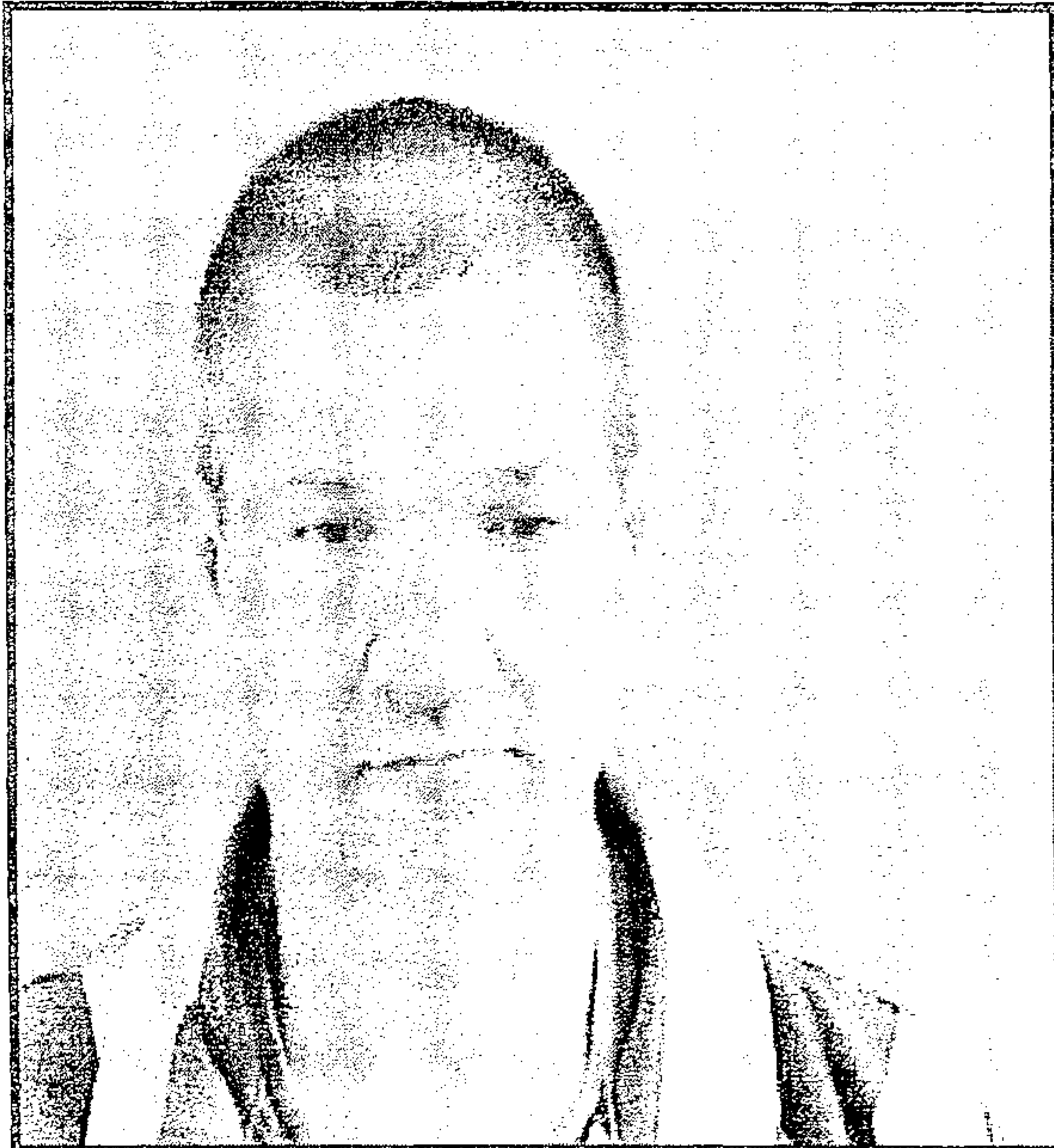

Michael Redmond

Charges follow assault over letting juvenile drive

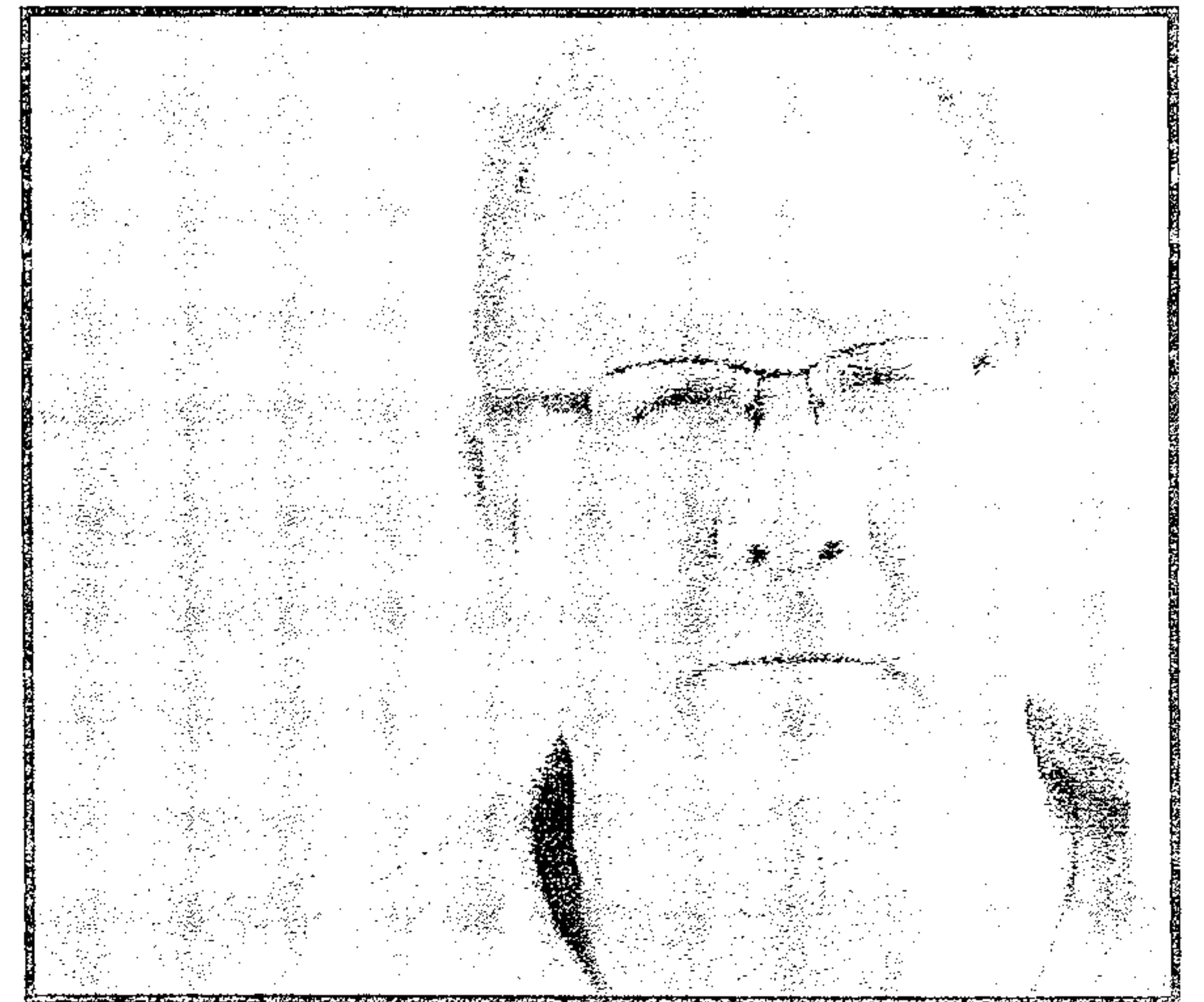

David Shaver

(see assault pg. 5)

LC teen charged with theft at Walmart

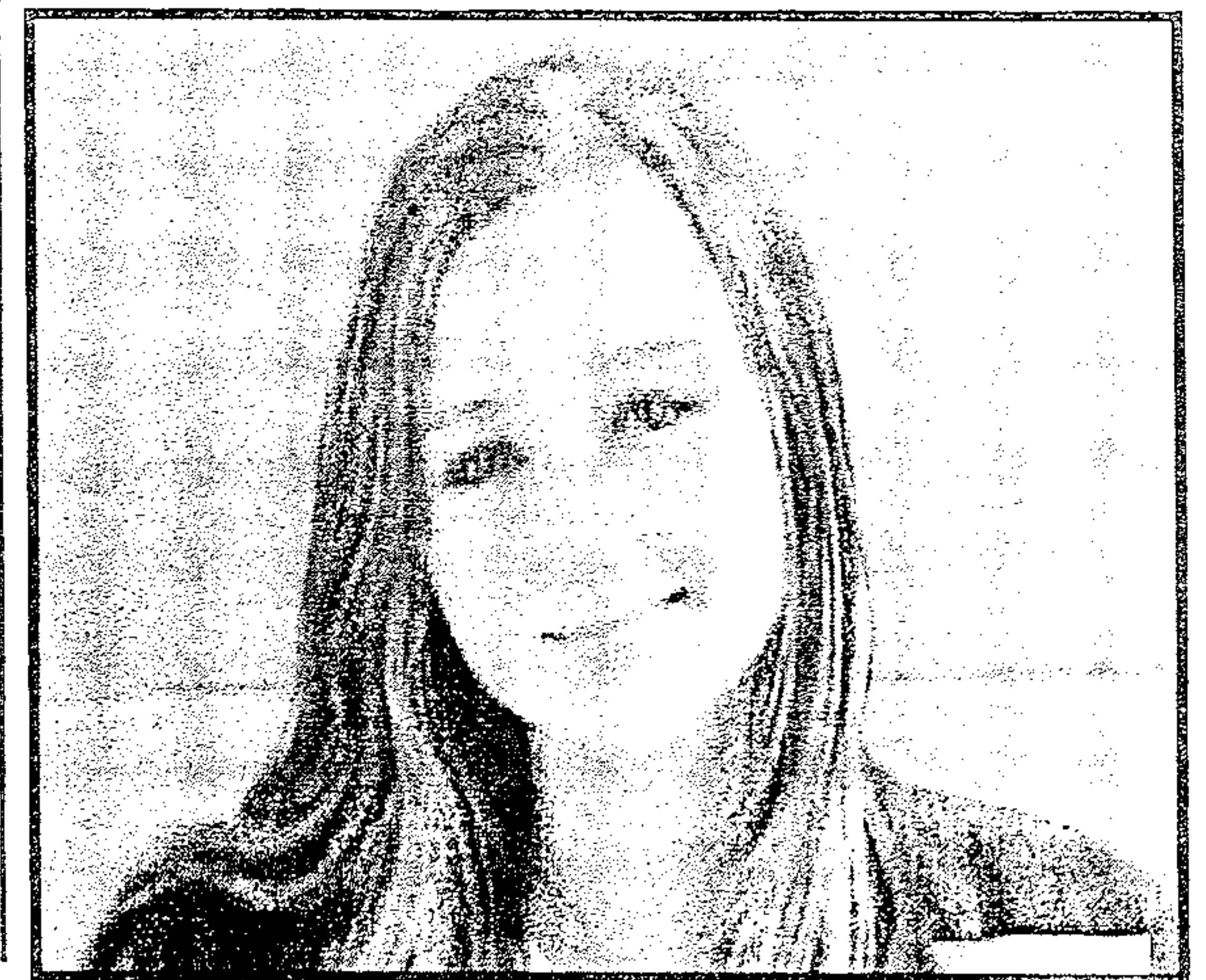

Emily Orr

(see theft pg. 3)

Syrian Cyber Hackers Charged

Two From 'Syrian Electronic Army' Added to Cyber's Most Wanted

Three members of a Syrian hacker collective that hijacked the websites and social media platforms of prominent U.S. media organizations and the U.S. military were charged today in federal court with multiple conspiracies related to computer hacking.

In two criminal complaints unsealed in the Eastern District of Virginia, Amad Umar Agha, Firas Dardar, and Peter Ro-

(see hackers pg. 7)

Clarksville Nonprofit Uses Federal Money to Personally Benefit Executive Director

The Tennessee Comptroller's investigation of the Cherry Tree Food Program in Clarksville, TN raises questions about \$181,135.59 spent by the nonprofit. Much of that money personally benefited the former executive director.

Cherry Tree is primarily funded by the federal Child and Adult

(see Clarksville pg. 4)

Verse of the Day

And we, who with unveiled faces all [contemplate and] reflect the Lord's glory, are being transformed into his likeness with ever-increasing glory, which comes from the Lord, who is the Spirit.

— 2 Corinthians 3:18

Obituaries

see inside
Wazzup

Be careful where you go to enjoy you holiday this weekend. In Lenoir City make sure you don't get called in after you leave

the business we got a couple that have a bad habit of that, just saying!

Weather

Today: Sunshine and clouds mixed. High 71F.

Tonight: Cloudy skies during the morning hours followed by thunderstorms in the afternoon. A few storms may be

severe. High 69F.

Tonight: Thunderstorms likely in the evening. Then the chance of scattered thunderstorms later on. Low 46F.

Friday Sun and a few passing clouds. High 64F.

Friday Night Clear. Low near 40F.

(Continued on page 6)



3 08805 93489 2

LCSO
 prowler call of someone walking around a residence on Old Spears Road. Dispatch advised the complainant had located a female walking down Beals Chapel Road, and she had been picked up by someone. Complainant stated the vehicle was blue Chevrolet. Complainant stated he fol-

lowed the vehicle and lost it on Beals Chapel Road. Deputy located the vehicle on Ford Road, turned around on the vehicle and made a traffic stop. Deputy came in contact with 3 subjects inside the vehicle. Deputy separated the subjects and ask what was going on. The subjects story did not match up or make sense.

Deputy ask why they were on Beals Chapel they stated picking up the female. Deputy ask if they had anything illegal all stated no. Sgt. Mike Watkins arrived with his K-

(see THP ctd. pg. 4)

To Get a Burning Permit:

Loudon (865) 986-8395
 Monroe (423) 442-7401
 Roane (865) 354-1054

Notice: The Daily Edition does not knowingly accept fraudulent or misleading materials. The Daily Edition cannot guarantee the validity of offerings or statements contained herein. All liability for the contents of all advertising, and for any claims that may arise therefrom, is the responsibility of the advertiser or its agency. The Daily Edition reserves the right to reject, edit, or abbreviate any advertisement submitted. Advertising is accepted with the understanding that all liability for all copyright violations is the sole responsibility of the advertiser. Photographs, artwork and other copy submitted for publication is considered the sole property of the advertiser. The Daily Edition will make every effort but will not be liable for failure to publish and ad or for typographical and layout errors. All statements and information about highlights featured items, letters to the editor, herein are those solely given to the interviewer or writer and the Daily Edition assumes no responsibility of the accuracy or validity thereof. The Daily Edition will gladly reprint at no charge that part of an advertisement in which an error occurs provided a claim is made within 3 days of the first publication of the ad. Information contained in the Wazzup is received anonymously and the Daily Edition assumes no responsibility for information and reserves the right to edit or reject any and/or all submissions. The Daily Edition is a daily newspaper of general circulation in Loudon County defined under TCA 2-1-104(a)(13). The Daily Edition also serves Monroe, Knox, Anderson, Roane and Blount counties and serves 30,000 readers weekly. Send mail to PO Box 1240, Lenoir City TN 37771. 865-771-2249. email: dan1204us@yahoo.com
 The Daily Edition is Loudon County's premier public interest and paid advertising paper. The Daily Edition is produced and published daily Monday through Friday and is circulated throughout Loudon County and parts of Monroe and Knox Counties. Display advertising rates \$5.00 per column inch and quantity discounts available. Call for information on upcoming promotions and events.

HACIENDA Ayala's
Mexican Restaurant
 Market Dr. * Lenoir City (In Front of Food City)

Real Authentic Mexican Food at Affordable Prices

BEST MARGARITA

You've Tried The Rest
 Now Come Have The Best!!!

We Accept ALL Competitors Coupons Outside of Mexico City!

986-3553

Good Credit OK • Bad Credit OK • Bankruptcies OK • Repo OK



2010 Kia Soul Sporty, 4 cyl, Auto, PW, PL, A/C, Great On Gas, Like New



2010 Ford Escape Limited Leather, Alloy Wheels, Heat, A/C, Luggage Rack, 79K,



2007 Dodge Ram 1500 Quad Cab, Thunder Road PKG, 20 in. Wheels, Low Miles, Hemi



2008 Ford Explorer 84k, 3rd Row Seating, Luggage Rack, Tow Pkg, PW, PL



2011 Ford Ranger Low Miles, Tow Pkg, New Tires, A/C, Heat, Bed Liner.



2011 Dodge Grand Caravan DVD, Stow & Go, Loaded, Remote Doors, Rear A/C

DEPENDABLE MOTORS 986-9343
 803 E. Broadway • Lenoir City

Serving Loudon County for 20 Year

* WAC. See Dealer for details

Visit our website at: www.dependablemotorslc.com

theft

Emily Orr, 19, Jim Conner Road Lenoir City, was charged with Theft of Property. Officer Christian Dragon LCPD, was dispatched to Walmart on a shoplifter. Upon

arrival Officer made contact with Loss Prevention who stated that he observed Emily Orr conceal several items in her purse and diaper bag and left the store without paying. Items totaled \$150.00 Emily was placed under arrest. Officer Christian Dragon LCPD, made the arrest.

Friends of the Knox County Public Library.

Morgan will deliver the Wilma Dykeman Stokely Memorial Lecture at the Bijou

Theatre on Thursday, April 7, at 7 p.m. to honor Dykeman as a novelist, journalist, educator, historian, and environmental-

(see Bijou ctd. pg. 5)

For Sale: Oak Wood Mulch

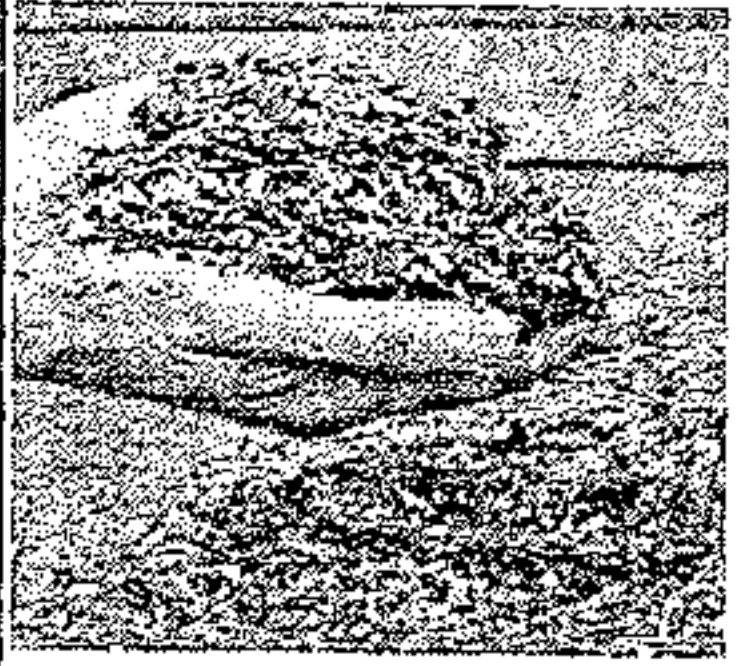

Mushroom Compost Topsoil.



Call Steve Spoon 986-4282

Morgan to be a Bijou KNOXVILLE, TN— Robert Morgan, the acclaimed author of Gap Creek and The Road from Gap Creek, will speak about the impact of Wilma Dykeman's fiction and non-fiction in his own work at the beginning of a two-day tribute to Dykeman on April 7 and 8.

The events are sponsored by the Library Society of the University of Tennessee and the

C&C Lawn Care
Mowing, Mulching, Trimming, Edging, Clear Debris
Free Estimates
Call Chad 865-271-8070

West End Storage & Warehouses
502 Ward Avenue • Loudon
Call 865-458-4774 or 865-679-5555

STAINED INK
TATTOO & PIERCING
LENOIR CITY 865 816-6440
NEW OWNER • NEW ARTIST • SINCE 2011
521 Hwy 321 next to Vape & Stuff & Inn Of Lenoir!
Clean-Affordable-Quality-Custom
Tattoo's You've Always Wanted!

BRING IN THIS AD FOR **\$25 OFF**
NEW INK FOR NEW CUSTOMERS ONLY!

Check us out on FB.com/
Stained.Ink.Tattoo/
www.STAINEDINK.com

C&J Towing and Recovery
LOWEST TOWING RATES AROUND!!!

Have you been overcharged for any type of towing service in the Lenoir City area? If you have a breakdown or accident please OWNER REQUEST C&J Towing with the officer. Also please call your Sheriff and ask him to place C&J Towing on the "Rotation List*" and help other motorists save as much as you did! We at C&J are locally owned and operated, State approved, licensed, bonded and insured. Call and let us know if your denied service or how we can be of assistance.

*note: the "Rotation List" is a list of wrecker services that provide service for wrecks, DUI's, breakdowns, etc. and are on an on-call basis for service. This list is approved by the Sheriff.

Cliff Teeters • Owner
865-809-1661

BIMBO'S
Deli Open 24 Hours
865-986-9643 Call Ins Welcome
Specials
Lg. Cold Sub, bag of chips and 16 oz. fountain drink only \$6.29
Footlong Corn Dog \$2.59

Clarksville

Care Food Program, which is administered in Tennessee by the Department of Human Services (DHS). As of July 1, 2015, Cherry Tree supported 267 daycare homes and 23 daycare centers in Tennessee by assisting them in filing monthly claims for meal reimbursements. Cherry Tree is reimbursed for

its administrative expenses. Comptroller investigators are questioning \$181,135.59 spent by Cherry Tree between October 1, 2012 and June 30, 2015. These expenditures were not approved by DHS in Cherry Tree's annual budgets. Many of these unauthorized payments benefited the former executive director. The

offices for Cherry Tree were located in a portion of the former executive director's personal residence. These expenses include: \$38,792.31 for a gazebo, new water heater, wrought iron handrails, replacement of windows and vinyl siding, installation of tile floors, installation of kitchen and bathroom sinks, ceiling fans,

electrical work, and various other maintenance and repairs to the former executive director's home. Unauthorized lease payments totaling \$17,900 to the former executive director or her family. \$47,426.70 in unauthorized payments and questionable reimbursements to the former executive director \$57,072.98 in other

unauthorized and questionable disbursements including charges for hotel rooms, air travel, rental cars, furniture, fuel, and electronics. \$10,043.60 in food and beverage purchases at both stores and restaurants. \$9,300 in unauthorized Christmas bonuses, and personal loans with a total outstanding balance of \$600 paid to employees.

The findings and recommendations in the investigative report have been reviewed with the district attorney general for the Nineteenth Judicial District.

"The Tennessee Department of Human Services and Cherry Tree's board dropped the ball in this case," said Comptroller Justin P. Wilson. "DHS and the board should

(see Money ctd. pg. 5)

JOB FAIR

Tellico Village is a fun, challenging and rewarding place to work. And it's a beautiful location. Tellico Village is holding a job fair on Thursday, March 24th from noon to 4 p.m. at our Welcome Center at 202 Chota Road in the heart of our community. Look for the red job fair signs! We're hiring for golf maintenance, public works and our restaurants in Loudon and Monroe Counties. We hope to see you on the 24th. For information, call (865) 408-2627.

PUBLIC NOTICE

The Lenoir City Utilities Board is rescheduling their March 2016 Board Meeting which was scheduled for Monday, March 21, 2016, at 4:00 p.m. The new rescheduled time will be Monday, March 28, 2016, at 6:00 p.m. As always, the meeting will be held in the Council Chambers of City Hall located at 600 East Broadway, Lenoir City, Tennessee 37771.

NEED HELP WITH INCOME TAX? PROFESSIONAL TAX SERVICE

PRICE - 95% of returns between \$60-\$140

(No Coupons Required)

LOCALLY Owned & Operated - Open Year Round

30+ Years in the business

ALL Preparers with 10+ years experience

Pro Tax

111 E. Broadway

Lenoir City, TN 37771

Phone 865-986-4035

**US Armed Service Active Duty Personnel, "THANK YOU", Tax Return Free*

BUDGET Transmissions



302 S. Northshore Drive Knoxville

(865) 584-4391 budget-transmissions.com

Why Buy From Budget?

Free Towing From Lenoir City
or Loudon County

20 Years of BBB Zero Customer
Complaints Award Member

A+ Plus Rated

Huge Transmission Inventory

Best Technicians Period!!!

Call (865) 584-4391 Today!



Approved
Auto Repair



assault

David Shaver, 59, Windridge Road Friendsville, was charged with Domestic Assault. Deputy Billy Lewis LCSO, was dispatched to Windridge Road for a physical domestic. Upon arrival Deputy made contact with the victim who stated that she and David was having a talk on the

back porch over victim allowing a juvenile drive the vehicle, and victim stated it never happen. David spoke with his sister who stated that the juvenile had drove the vehicle. David and the victim got into an argument and David grabbed the victim by the hoodie and pushed her into the wall trying to get her cell phone. While this was going on the juve-

nile called 911. Victim stated that David then started chasing the juvenile trying to get her phone. Deputy placed David under arrest. Deputy Billy Lewis LCSO, made the arrest.

LCSO cont. from pg. 2

9, who was deployed and did alert on the vehicle. Michael Redmond was in front of

the vehicle with CPL. Bramam as Sgt. Watkins was walking back to Redmond he located a piece of paper laying on the ground that looked like it was just placed there. Deputy Watkins picked up the paper that had a crystal like substance believed to be methamphetamine. Redmond stated he had it in his

shoe and had kicked his shoe off and kicked it under the vehicle. The crystal substance weight approx. 1 gram. Deputy Kenneth Palmer LCSO, made the arrest.

Money cont. from pg. 4

have reviewed disbursements to ensure they conformed to the approved budgets. A lack of oversight allowed these problems to continue for more than 2 1/2 years."

To view the investigation online, go to: <http://www.comptroller.tn.gov/ia/>

If you suspect fraud, waste or abuse of public money in Tennessee, call the Comptroller's toll-free hotline at (800) 232-5454, or file a report online at: www.comptroller.tn.gov/hotline. Follow us on twitter @TN-COT

Bijou ctd. from pg. 3

ist. The following morning, Morgan will lead a panel of experts on Appalachian literature and culture in a discussion of Dykeman's far-reaching contributions to our region. The forum will be held in UT's John C. Hodges Library, from 10 to 11:30 a.m., Friday, April 8.

Both events are free and open to the public. Online registration is requested for Morgan's lecture on April 7, at knoxfriends.org/robert-morgan.

PURDY'S AUTO PARTS AND SALVAGE
WE BUY SCRAP IRON • COPPER • BRASS • ALUMINUM



Paying Top \$\$\$
 Call For Latest Prices

You Name It, We Buy It!

Radiators, Wheels, Batteries, Appliances, Farm Equipment

Copper
 Paying Top \$\$\$
 Call For Latest Prices

Complete Cars
 per 100 lbs.

Scrap Metal
 Paying Top \$\$\$
 Call For Latest Prices
 per 100 lb

We Buy Batteries

Aluminum Cans
 Paying Top \$\$\$
 Call For Latest Prices

You Call We Haul!
423-519-5402

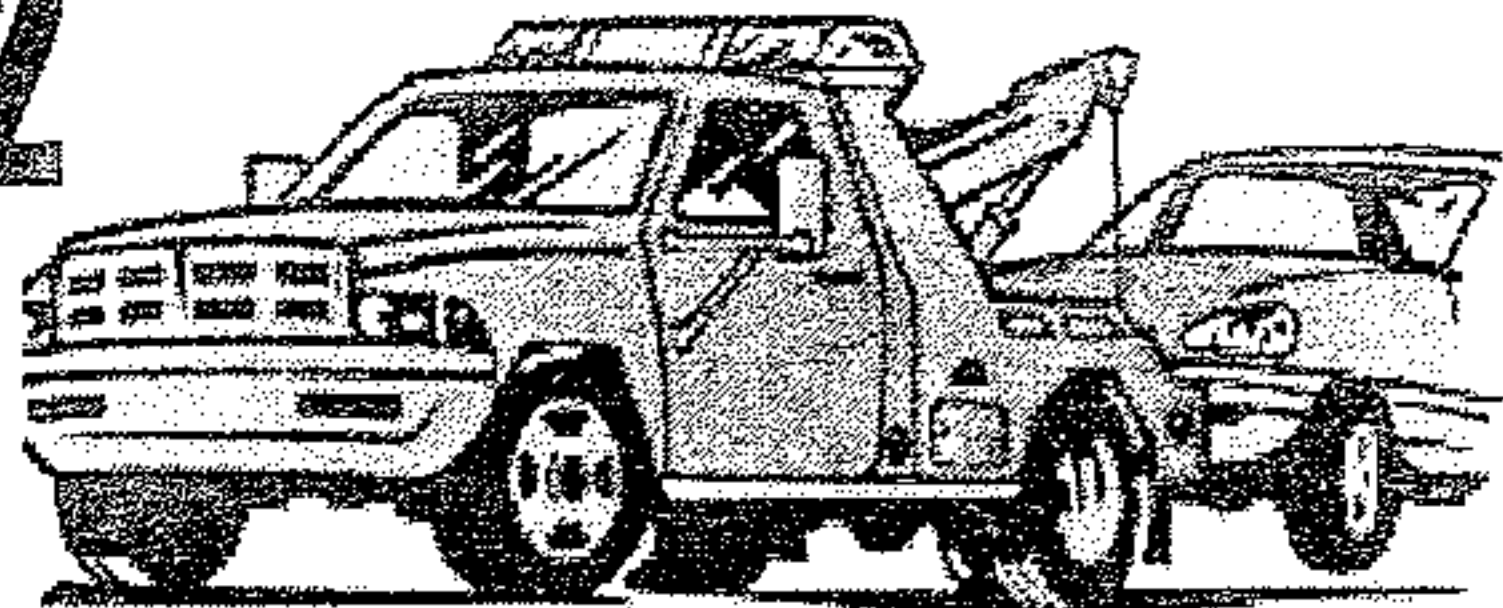

* Prices subject to change with the market.

423 337-3977
149 County Road 323 Sweetwater

**Now Selling
 Aftermarket
 Body Parts at
 Discount Prices**

* Prices subject to change with the market.

FBI

mar were charged with criminal conspiracies related to their roles targeting Internet sites—in the U.S. and abroad—on behalf of the Syrian Electronic Army (SEA), a group of hackers that supports the regime of Syrian President Bashar al-Assad. The affected sites—which included computer systems in the Executive Office of the President in 2011 and a U.S. Marine Corps recruitment website in 2013—were deemed by SEA to be antagonistic toward the Syrian government.

According to the charges, Agha, 22, known online as “The Pro,” and Dardar, 27, engaged in a multi-year conspiracy that began in 2011 to collect usernames and passwords that gave them the

ability to deface websites, redirect domains to sites controlled by the conspirators, steal e-mail, and hijack social media accounts. To obtain the login information they used a technique called “spear-phishing,” where they tricked people who had privileged access to their organizations’ websites and social media channels into volunteering sensitive information by posing as a legitimate entity.

The FBI today added Agha and Dardar—both believed to be in Syria—to its Cyber’s Most Wanted. The Bureau is offering a reward of up to \$100,000 each for information that leads to their arrest; anyone with information is asked to contact the FBI or the nearest U.S. Embassy or consulate. Tips can also be submitted online at tips.fbi.gov.

Dardar, known online as “The Shadow,” also worked with Peter

“Pierre” Romar, 36, on a scheme beginning in 2013 to extort U.S. businesses for profit. According to the complaint, the pair would hack into the victims’ computers and then threaten to damage computers, and delete or sell the data unless they were paid a ransom.

Other examples of the conspirators’ hacks include:

Compromising the Twitter account of a prominent U.S. media organization in 2013 and releasing a tweet claiming that a bomb had exploded at the White House and injured the President.

Gaining control of a U.S. Marine Corps recruiting website and posting a message urging Marines to “Refuse [their] orders.”

In a statement, Assistant Attorney General for National Security John

Carlin said the conspirators’ extortion schemes undermine their own claims of working for a noble cause—to support the embattled regime of their president. “While some of the activity sought to harm the economic and national security of the United States in the name of Syria, these detailed allegations reveal that the members also used extortion to try to line their own pockets at the expense of law-abiding people all over the world,” Carlin said.

The U.S. District Court has issued arrest warrants for all three defendants. The FBI’s Washington Field Office (WFO) is investigating the case with assistance from the NASA Office of the Inspector General and Department of State Bureau of Diplomatic Security,

see FBI ctd. pg. 8

Public Notice
 The Loudon County Corrections Partnership Committee will meet March 30, 2016 at 12:00 at the Justice Center to discuss future plans.

LOOK! \$75 Weekly Payments LOOK!

MARTY'S AUTO SALES • 986-2222 • MARTY'S AUTO SALES • 986-2222 • MARTY'S AUTO SALES • 986-2222 • MARTY'S AUTO SALES • 986-2222 • MARTY'S AUTO SALES •

Bad Credit
Divorce
Fixed Income
Repos
Bankruptcy
No Credit

APPROVED! **NO CREDIT CHECKS**

Visit Us On The Web At:
martysautosales.net

| | | | |
|--|--|---|--|
|  <p>\$99 down*</p> <p>97 Escort, auto, gas saver Only \$99 down *</p> |  <p>\$299 down*</p> <p>03 Taurus, runs good, Only \$299 down *</p> |  <p>\$199 down*</p> <p>99 Venture, 7 passenger, Only \$199 down *</p> |  <p>\$499 down*</p> <p>01 Sebring 2dr. sporty, Only \$499 down *</p> |
|  <p>\$599 down*</p> <p>05 Trailblazer, auto, good miles Only \$599 down *</p> |  <p>\$499 down*</p> <p>04 Aveo, auto, gas saver, Only \$499 down *</p> |  <p>\$799 down*</p> <p>06 Tiburon GT, 5 speed, sporty, Only \$799 down *</p> |  <p>\$99 down*</p> <p>98 Bonneville, 6 cyl, Auto, low payments only \$99 down *</p> |

NO Credit Checks **Marty's Auto Sales** **100% Approval***
 986-2222 Se Habla Espanol

*See Dealer for details. All down payments plus tax, tag, title and fees.

MARTY'S AUTO SALES • 986-2222 • MARTY'S AUTO SALES • 986-2222 • MARTY'S AUTO SALES • 986-2222 • MARTY'S AUTO SALES • 986-2222 • MARTY'S AUTO SALES •

FBI ctd. from pg. 7

and other law enforcement agencies.

“These three members of the Syrian Electronic Army targeted and compromised computer systems in order to provide support to the Assad regime as well as for their own personal monetary gain through extortion,”

said WFO Assistant Director in Charge Paul M. Abbate. “As a result of a thorough cyber investigation, FBI agents and analysts identified the perpetrators and now continue to work with our domestic and international partners to ensure these individuals face justice in the United States.”

Is Your Washer Broken?
Call Me
I Only Charge \$100 Period!!!
Call Allen
865-617-7113

THE RELIC SHOP
 521 Hwy 321 Lenoir City Suite 3
 next to Stained Inc and the Inn of Lenoir
865-250-9280
 HUGE NEW SELECTION OF FOSSILS, ARTIFACTS,
 COINS, AND MORE
ALL AMETHYST 40% OFF
 GREAT SELECTION OF ANCIENT MEGALADON
 SHARK TOOTH OVER 8 MILLION YEARS OLD

A Name You Already Know And Trust Just Got Even More Dependable
DEPENDABLE AUTO SERVICE, LUBE AND TIRES
is Now Offering
Expert, Affordable Transmission Service
 All ASE Certified Technicians

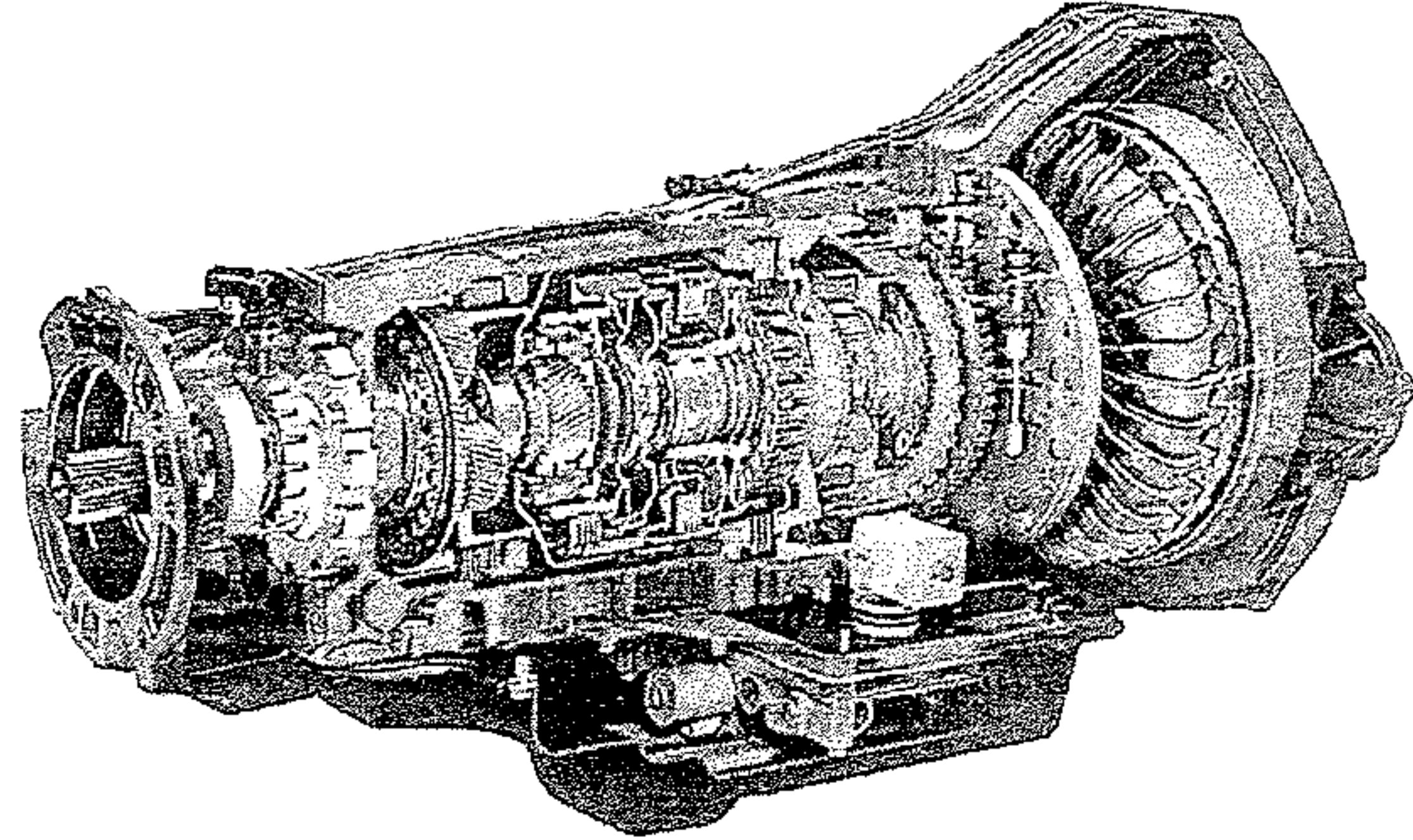

We proudly welcome all New Customers
 and Former Advanced Transmission
 Customers with a 10% Discount and Any
 Transmission Service or Repair*

865-986-9359

865-986-5050

Bad Credit, No Credit OK!!! We Finance Everybody!!!
Taxes Done Here!!! Bring your last pay stub or W2 and DRIVE TODAY!!!

Over 100 Cars, Trucks & Vans in Stock - Warranties On ALL Vehicles Sold!!!



2007 Chevrolet Uplander,
60k miles, NICE!!!

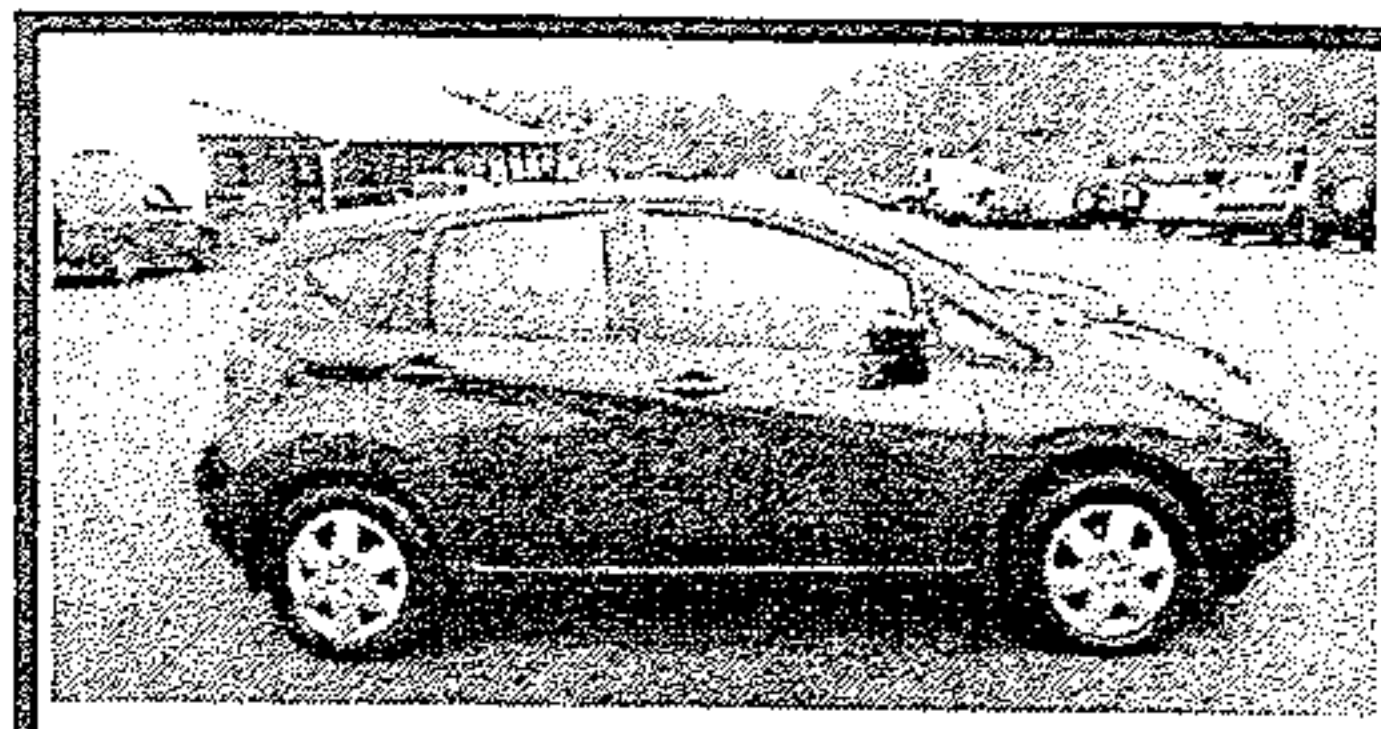

2015 Nissan Versa Note, Fac-
tory Warranty, Low Miles

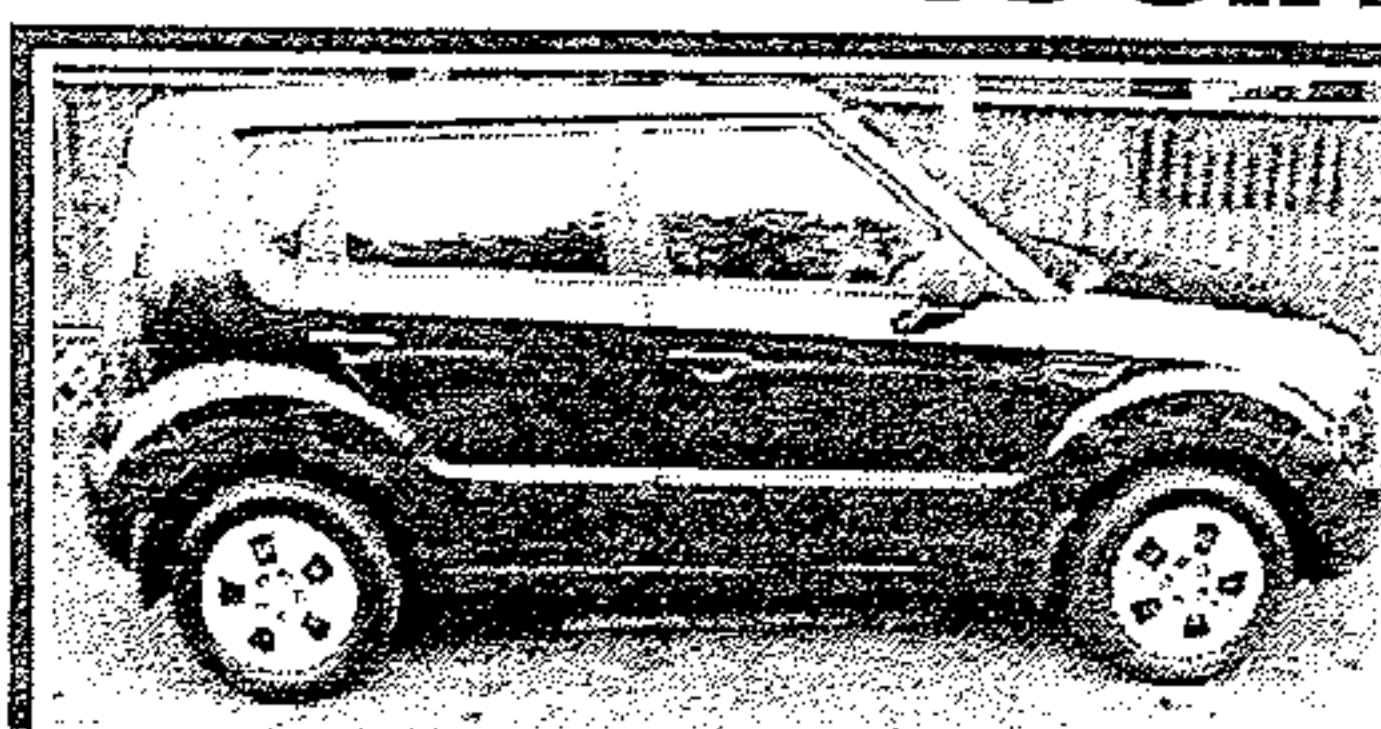

2011 Kia Soul, 5 speed, 4 dr,
Gas Saver, Nice & Clean



2008 Saturn VUE, LOADED!!!
4dr, Ready to go on a trip!

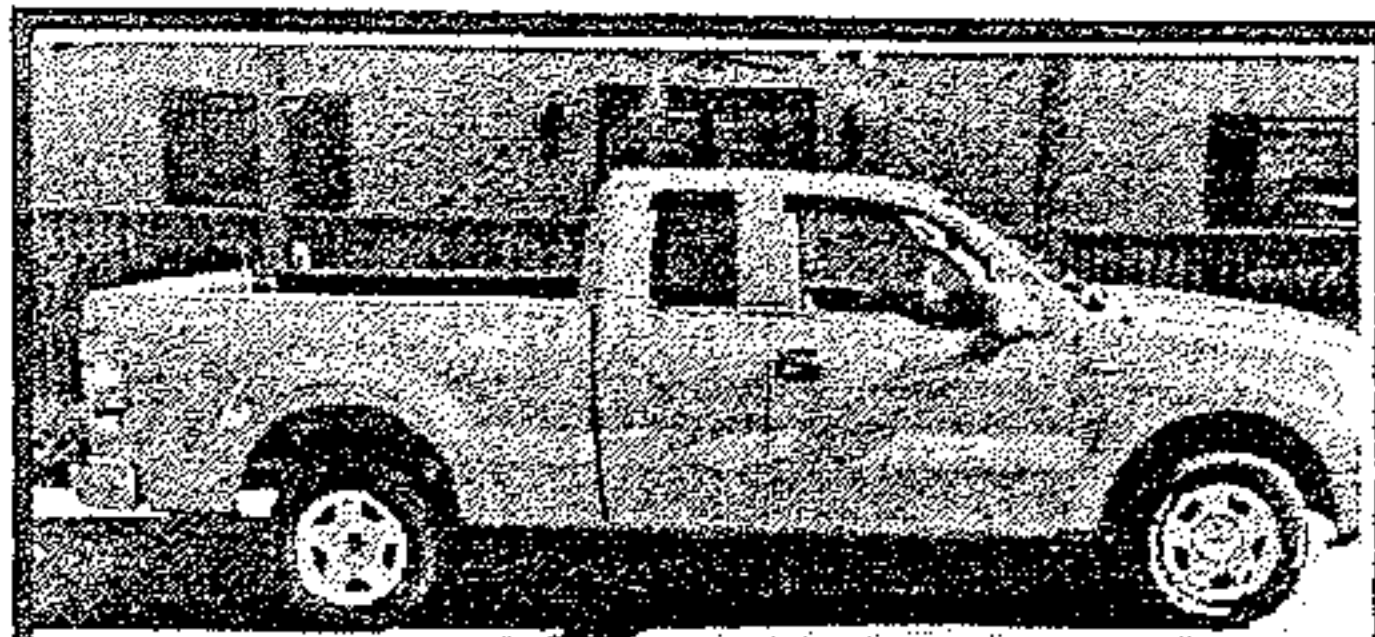

2007 Ford F150, Extra Cab,
Clean, Nice Truck

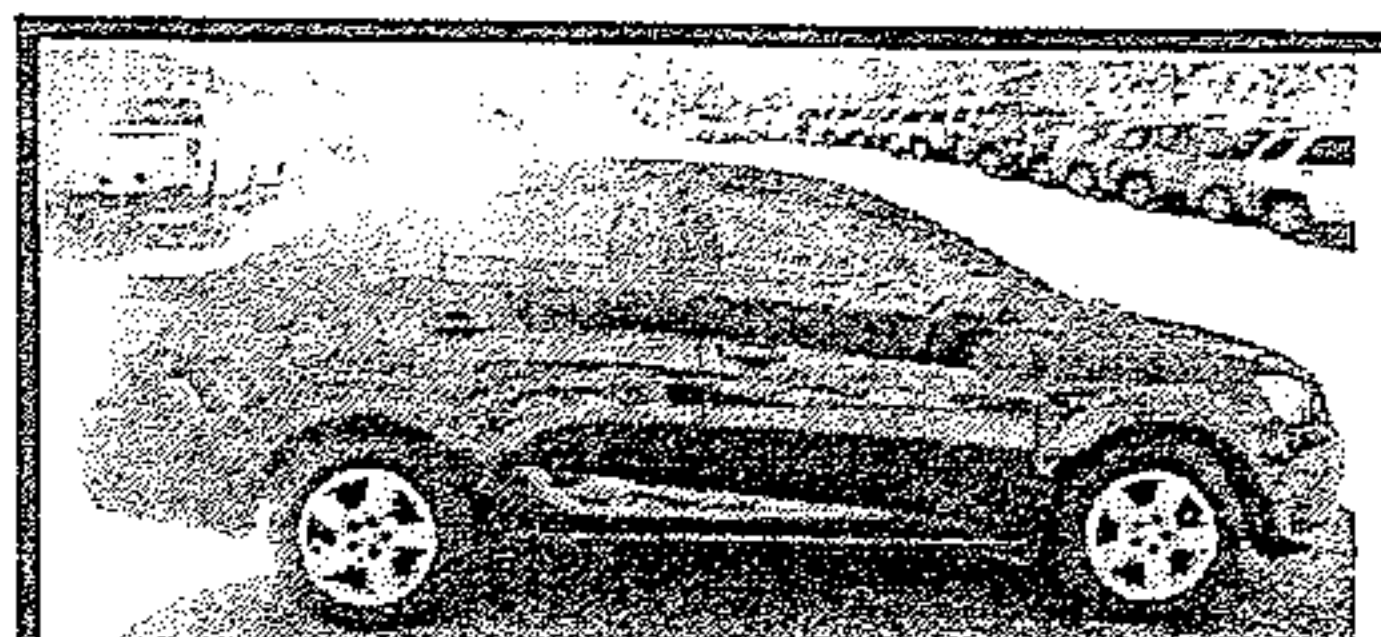

2014 Chevy Sonic, Factory
Warranty, Low Miles!



Mitsubishi Raider, Ext. Cab,
Super Nice Truck

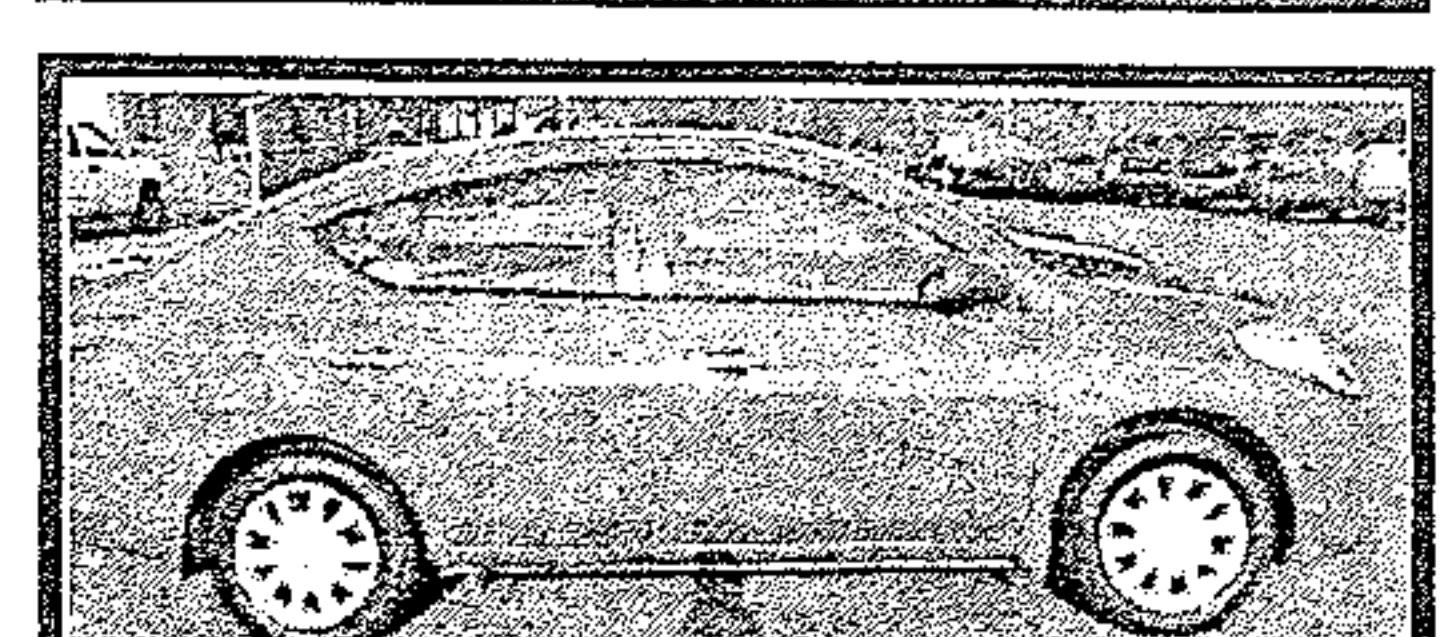

2013 Nissan Versa, Like New!
LOADED!!!

WALT WILLIAMS, INC.

*with approved credit
3003 Highway 11 Lenoir City, TN 865-986-1111