

The Daily Edition

50¢

Serving Loudon, Monroe and Surrounding Counties

Wednesday, March 23, 2016

THP Upgrades charges to vehicular assault due to injuries in Hwy 411 Crash

A 64 year old Greenback man has been charged with three counts of vehicular assault by the Tennessee Highway Patrol following a serious crash that sent 4 to the hospital including the man charged. THP reported they they a twelve pack with three missing and upon talking to the man found out he was on all kinds of medication also including morphine.

(see THP pg. 2)



Warren Gaston

Update: Kidnapping and Rape charges follow investigation



Natasha Ramsey

(see Update pg. 5)

Forged check cashed; charges placed



Harley Grimes

Former Cheatham County Central Band Booster Club Treasurer Indicted for Theft

A special investigation by the Tennessee Comptroller's Office has revealed that Tracy Krantz stole at least \$3,072 from the Cheatham County Central High School Band Boosters.

Ms. Krantz stole the money between July 2013 and October 2013 while serving as the band booster club treasurer.

Comptroller investigators found that Ms. Krantz made unauthorized

(see indicted pg. 7)

Lingering Problems Go Uncorrected in Haywood County

The Comptroller's annual audit of Haywood County government identifies a troubling trend. Eight of the county's 12 findings in this year's report were also noted in the county's prior audit. This indicates that significant deficiencies and issues of noncompliance have gone uncorrected for more than a year.

(see Problems pg. 4)

Verse of the Day

But now a righteousness from God, apart from law, has been made known, to which the Law and the Prophets testify. This righteousness from God comes through faith in Jesus Christ to all who be-

lieve. — Romans 3:21-22

Obituaries

see inside

Wazzup

Gonna be a beautiful week this week but chilly no less. Don't let the chill keep ya from climbing the hill!

Weather

Today: Sunshine and clouds mixed. High 71F.

Tonight: A few clouds from time to time. Slight chance of a shower late. Low around 55F.

Thursday Cloudy in the morning, then thunderstorms developing later in the day. High 68F.

Thursday Night Thunderstorms during the evening followed by occasional showers overnight.

Low 42F.

Horoscopes

Aries 3/21-4/19

Finishing your work may be impossible today, especially if you underesti-

(Continued on page 6)

(see LCPD pg. 3)



THP

Warren Gaston, 64, Fork Road Greenback, was charged with DUI, and Vehicular Assault x3. Trooper Rodney Best THP, was dispatched to a crash with injury on Hwy 411 at Thompson Bridge Road. Trooper was advised that Life Star was landing and Hwy 411 would be shut

down. Upon arrival Trooper observed a green vehicle on the right side of the roadway and a silver vehicle on the left side of the roadway. Trooper was advised by Deputies on scene that all parties had been transported to UT Medical. Trooper was advised that the driver of the silver vehicle smelled and appeared to have

been drinking. Trooper located a twelve pack of beer in the silver vehicle with nine in the pack. The driver of the silver vehicle was identified as Warren Gaston. There was

(see THP ctd. pg. 4)

To Get a Burning Permit:

Loudon (865) 986-8395

Monroe (423) 442-7401

Roane (865) 354-1054

Notice: The Daily Edition does not knowingly accept fraudulent or misleading materials. The Daily Edition cannot guarantee the validity of offerings or statements contained herein. All liability for the contents of all advertising, and for any claims that may arise therefrom, is the responsibility of the advertiser or its agency. The Daily Edition reserves the right to reject, edit, or abbreviate any advertisement submitted. Advertising is accepted with the understanding that all liability for all copyright violations is the sole responsibility of the advertiser. Photographs, artwork and other copy submitted for publication is considered the sole property of the advertiser. The Daily Edition will make every effort but will not be liable for failure to publish and ad or for typographical and layout errors. All statements and information about highlights featured items, letters to the editor, herein are those solely given to the interviewer or writer and the Daily Edition assumes no responsibility of the accuracy or validity thereof. The Daily Edition will gladly reprint at no charge that part of an advertisement in which an error occurs provided a claim is made within 3 days of the first publication of the ad. Information contained in the Wazzup is received anonymously and the Daily Edition assumes no responsibility for information and reserves the right to edit or reject any and/or all submissions. The Daily Edition is a daily newspaper of general circulation in Loudon County defined under TCA 2-1-104(a)(13). The Daily Edition also serves Monroe, Knox, Anderson, Roane and Blount counties and serves 30,000 readers weekly. Send mail to PO Box 1240, Lenoir City TN 37771. 865-771-2249. email: dan1204us@yahoo.com The Daily Edition is Loudon County's premier public interest and paid advertising paper. The Daily Edition is produced and published daily Monday through Friday and is circulated throughout Loudon County and parts of Monroe and Knox Counties. Display advertising rates \$5.00 per column inch and quantity discounts available. Call for information on upcoming promotions and events.



HACIENDA Ayala's
Mexican Restaurant
 Market Dr. * Lenoir City (In Front of Food City)

Real Authentic Mexican Food at Affordable Prices

BEST MARGARITA

You've Tried The Rest
 Now Come Have The Best!!!

We Accept ALL Competitors Coupons Outside of Mexico City!

986-3553

Good Credit OK • Bad Credit OK • Bankruptcies OK • Repo OK



2010 Kia Soul Sporty, 4 cyl, Auto, PW, PL, A/C, Great On Gas, Like New



2010 Ford Escape Limited Leather, Alloy Wheels, Heat, A/C, Luggage Rack, 79K,



2007 Dodge Ram 1500 Quad Cab, Thunder Road PKG, 20 in. Wheels, Low Miles, Hemi



2008 Ford Explorer 84k, 3rd Row Seating, Luggage Rack, Tow Pkg, PW, PL



2011 Ford Ranger Low Miles, Tow Pkg, New Tires, A/C, Heat, Bed Liner.



2011 Dodge Grand Caravan DVD, Stow & Go, Loaded, Remote Doors, Rear A/C

DEPENDABLE MOTORS 986-9343
 803 E. Broadway • Lenoir City

Serving Loudon County for 20 Years

* WAC. See Dealer for details

Visit our website at: www.dependablemotorslc.com

abuse

Harley Grimes, 23, Highway 11E Luttrell, was charged with Criminal Attempt, Forgery x2. Harley Grimes did intentionally and knowingly pass a forged check at the

ORNL Credit Union located inside Food City. Grimes successfully passed the check and was paid cash by the credit union. The victim never wrote a check payable to Grimes and stated that his signature on the check was forged. Capt. Kevin Condee LCPD, made the arrest.

Marty Robinson, 36, Ruritan Road Harriman, was charged with Theft of Property. Marty Robinson was observed concealing misc. clothing totaling

\$70.74 into a Walmart bag and exit out the doors without paying for any of the concealed items. Officer Rick Eubanks LCPD, made the arrest.

For Sale: Oak Wood Mulch

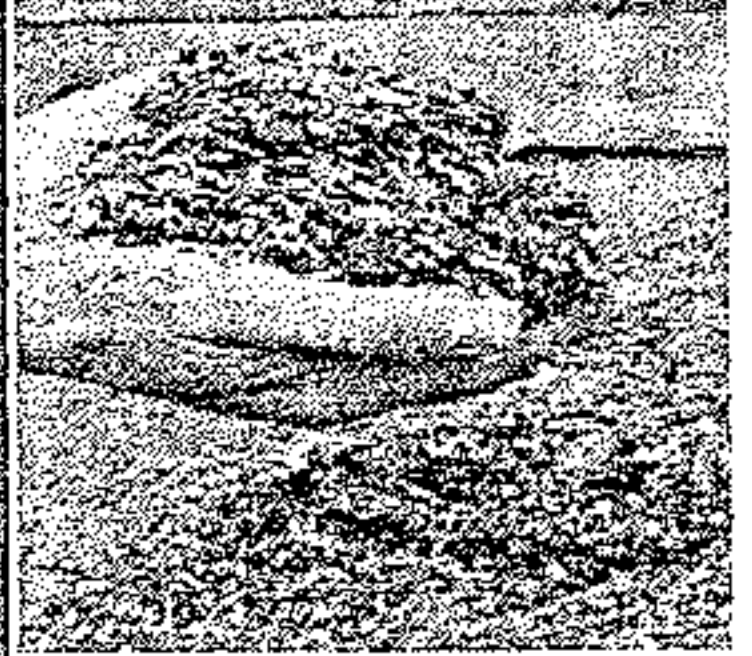

Mushroom Compost Topsoil.

Firewood



Call Steve Spoon
986-4282

Theft at Walmart

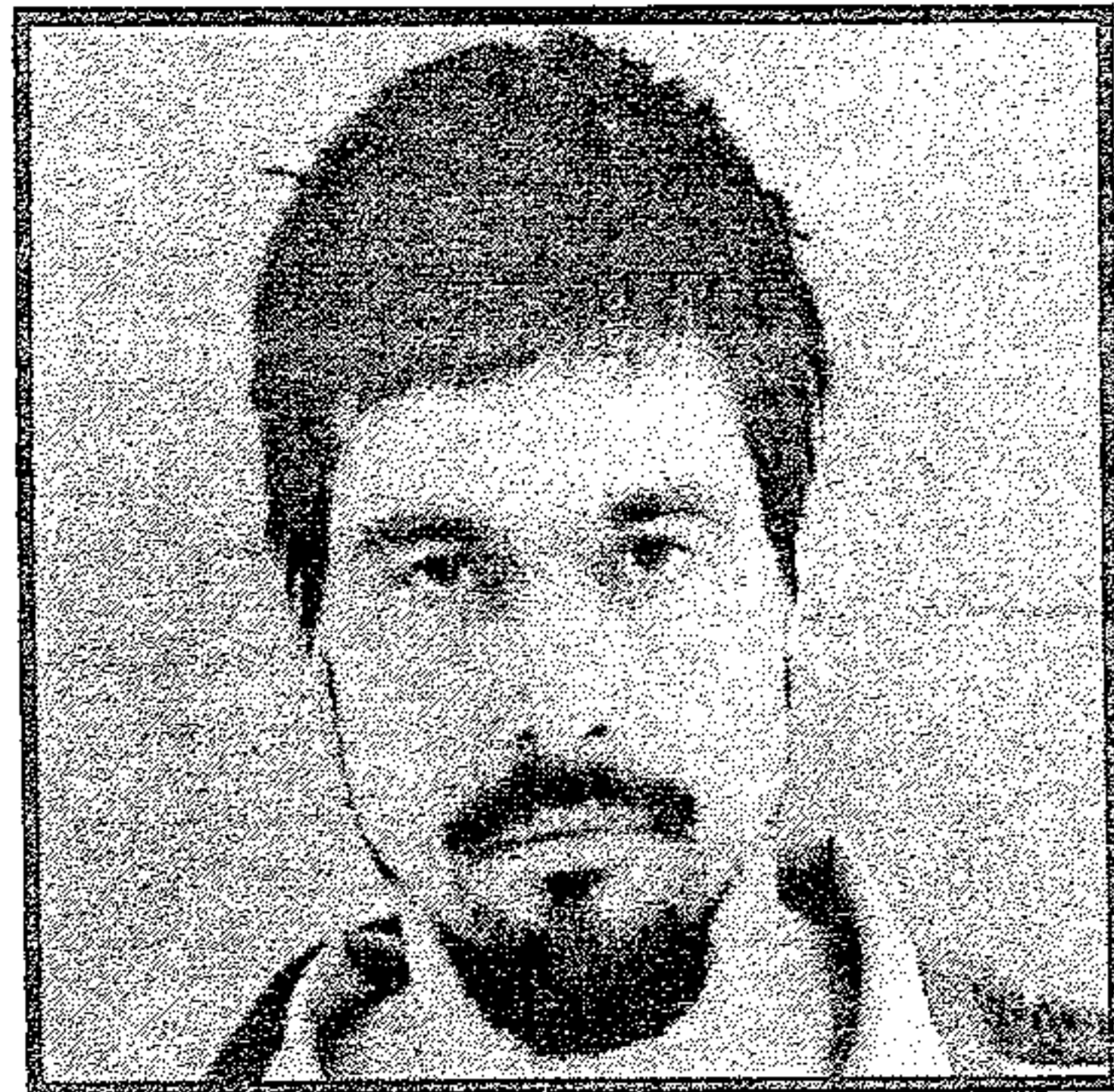

Marty Robinson

C&C Lawn Care
Mowing, Mulching, Trimming, Edging, Clear Debris
Free Estimates
Call Chad 865-271-8070

West End Storage & Warehouses
502 Ward Avenue • Loudon
Call 865-458-4774 or 865-679-5555

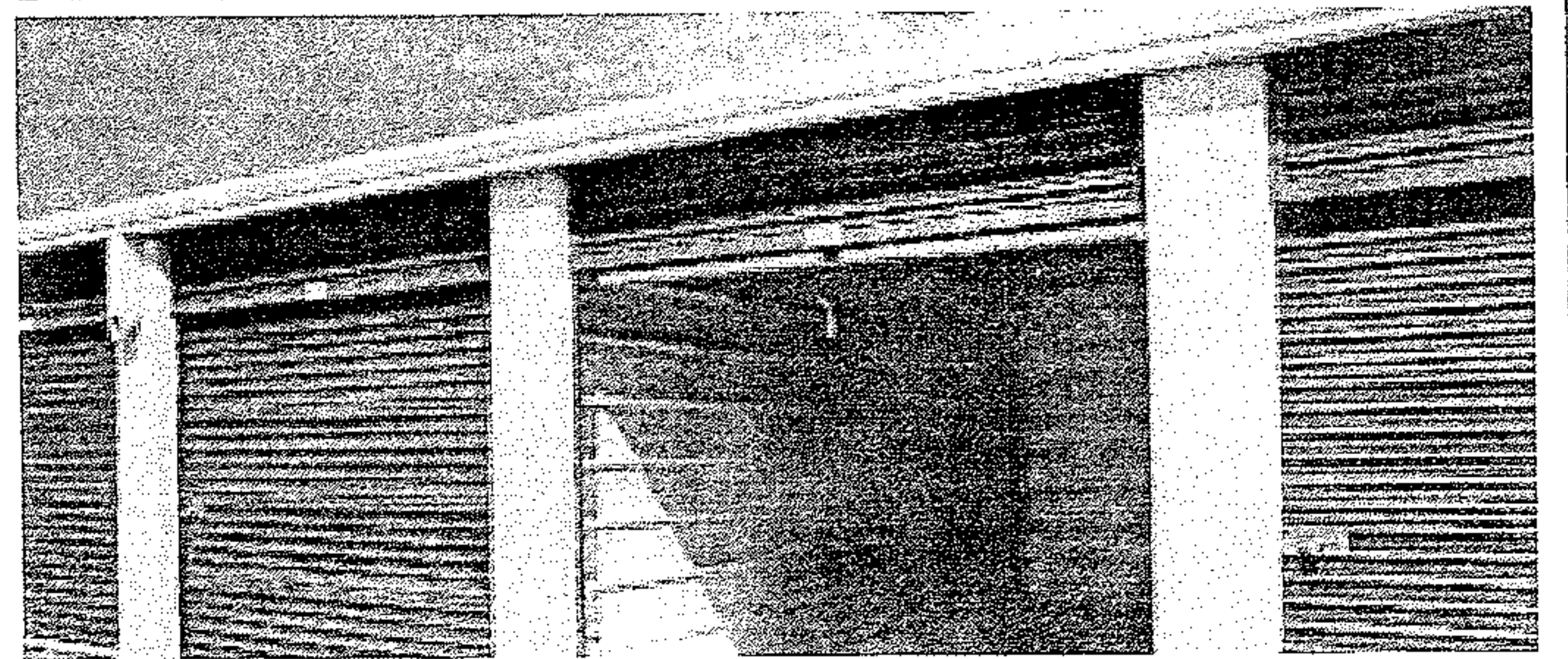

STAINED INC

TATTOO & PIERCING

LENOIR CITY 865 816-6440

NEW OWNER • NEW ARTIST • SINCE 2011

521 Hwy 321 next to Vape & Stuff & Inn Of Lenoir!

Clean-Affordable-Quality-Custom
Tattoo's You've Always Wanted!

BRING IN THIS AD FOR **\$25 OFF**
NEW INK FOR NEW CUSTOMERS ONLY!

Check us out on FB.com/
Stained.Inc.Tattoo/
www.STAINEDINC.com



BIMBO'S

Deli Open 24 Hours

865-986-9643 Call Ins Welcome

Specials

Lg. Cold Sub, bag of chips and 16 oz. fountain drink
only \$6.29

Footlong Corn Dog \$2.59

C&J Towing and Recovery

LOWEST TOWING RATES AROUND!!!

Have you been overcharged for any type of towing service in the Lenoir City area? If you have a breakdown or accident please OWNER REQUEST C&J Towing with the officer. Also please call your Sheriff and ask him to place C&J Towing on the "Rotation List*" and help other motorists save as much as you did! We at C&J are locally owned and operated, State approved, licensed, bonded and insured. Call and let us know if your denied service or how we can be of assistance.

*note: the "Rotation List" is a list of wrecker services that provide service for wrecks, DUI's, breakdowns, etc. and are on an on-call basis for service. This list is approved by the Sheriff.

Cliff Teeters • Owner
865-809-1661

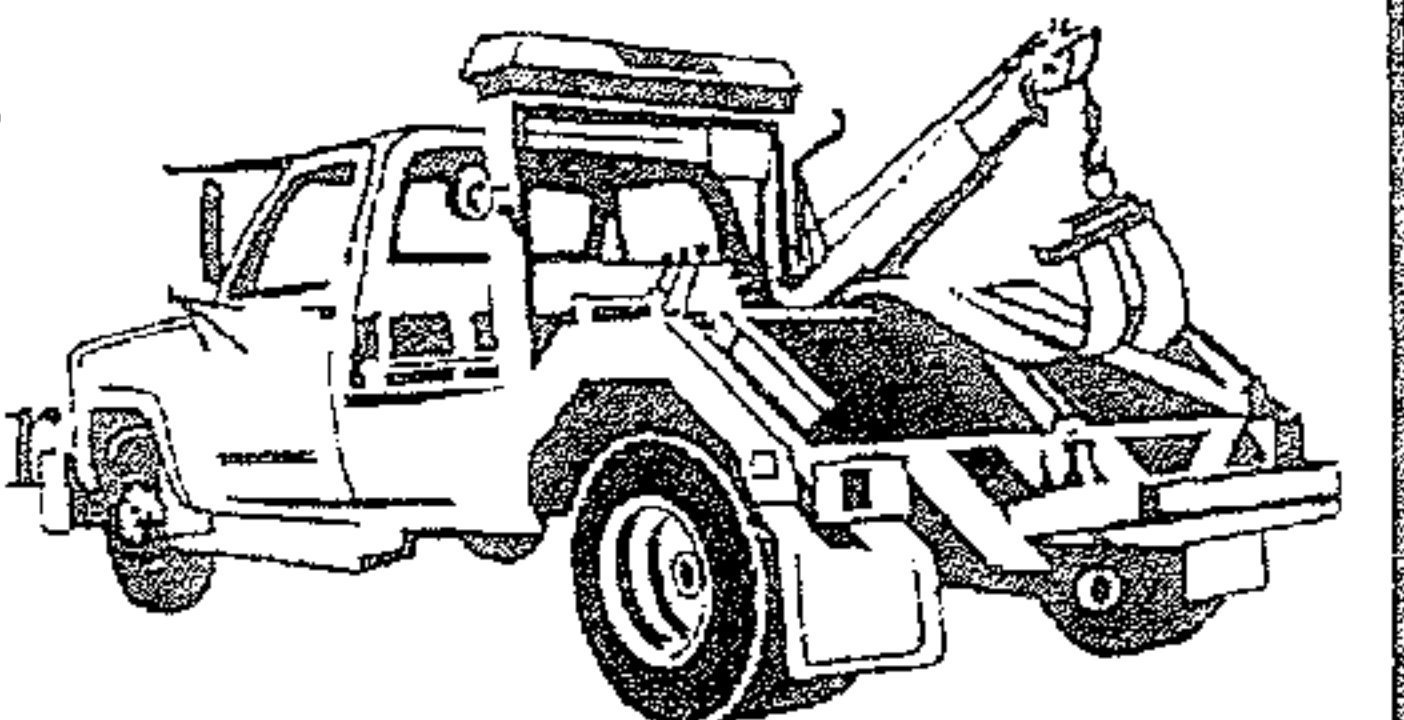

Problems

The 12 findings in the fiscal year 2015 audit are spread across several county offices, but eight of them pertain to the Office of the County Mayor.

Audit findings include a lease-purchase agreement and a capital outlay note that failed to comply with state statutes, expenditures exceeding appropriations, a failure

to control access to courthouse offices, and inadequate disaster recovery plans for computer data.

Comptroller auditors also found several problems with Haywood County's purchasing processes. For example, auditors noted that competitive bids were not solicited for \$206,955 in food purchases for the county jail. State statute requires competi-

tive bids on purchases exceeding \$10,000.

"It concerns me when a county has 12 audit findings for two consecutive years, particularly when many of those findings are repeated," said Comptroller Justin P. Wilson. "These audit reports should not be taken lightly. Taxpayers deserve to know that controls are in place to protect their money."

View the full Haywood

County Audit Report at <http://www.comptroller.tn.gov/la/>

If you suspect fraud, waste or abuse of public money in Tennessee, call the Comptroller's toll-free hotline at (800) 232-5454, or file a report online at: www.comptroller.tn.gov/hotline. Follow us on twitter: @TN-COT

GOOD SHEPHERD CENTER DINNER AND AUCTION

The Good Shepherd Center of Monroe County will hold its annual fund raising Dinner and Auction on April 2, 2016.

The location will be at the Tellico West Conference Center, 121 Grand Vista, Vonore TN 37885.

The silent auction will begin at 5:30 PM and the catered dinner will be at 6:30 PM.

Entertainment will be the dynamic singing duo known as Vocal Point.

Tickets are \$40 each, of which 20 dollars is income tax deductible. For those who wish to support the Good Shepherd but are unable to attend this function, there are Feed a Family tickets available, also \$40 each.

Tickets may be purchased at The Good Shepherd Center, The Monroe County Chamber of Commerce, the Kahite Club House and individual Good Shepherd volunteers.

The Good Shepherd Center is a 501©3 organization.

(see GS etd. pg. 5)

JOB FAIR

Tellico Village is a fun, challenging and rewarding place to work. And it's a beautiful location. Tellico Village is holding a job fair on Thursday, March 24th from noon to 4 p.m. at our Welcome Center at 202 Chota Road in the heart of our community. Look for the red job fair signs! We're hiring for golf maintenance, public works and our restaurants in Loudon and Monroe Counties. We hope to see you on the 24th. For information, call (865) 408-2627.

PUBLIC NOTICE

The Lenoir City Utilities Board is rescheduling their March 2016 Board Meeting which was scheduled for Monday, March 21, 2016, at 4:00 p.m. The new rescheduled time will be Monday, March 28, 2016, at 6:00 p.m. As always, the meeting will be held in the Council Chambers of City Hall located at 600 East Broadway, Lenoir City, Tennessee 37771.

NEED HELP WITH INCOME TAX? PROFESSIONAL TAX SERVICE

PRICE - 95% of returns between \$60-\$140

(No Coupons Required)

LOCALLY Owned & Operated - Open Year Round

30+ Years in the business

ALL Preparers with 10+ years experience

Pro Tax

111 E. Broadway

Lenoir City, TN 37771

Phone 865-986-4035

*US Armed Service Active Duty Personnel, "THANK YOU", Tax Return Free

BUDGET Transmissions

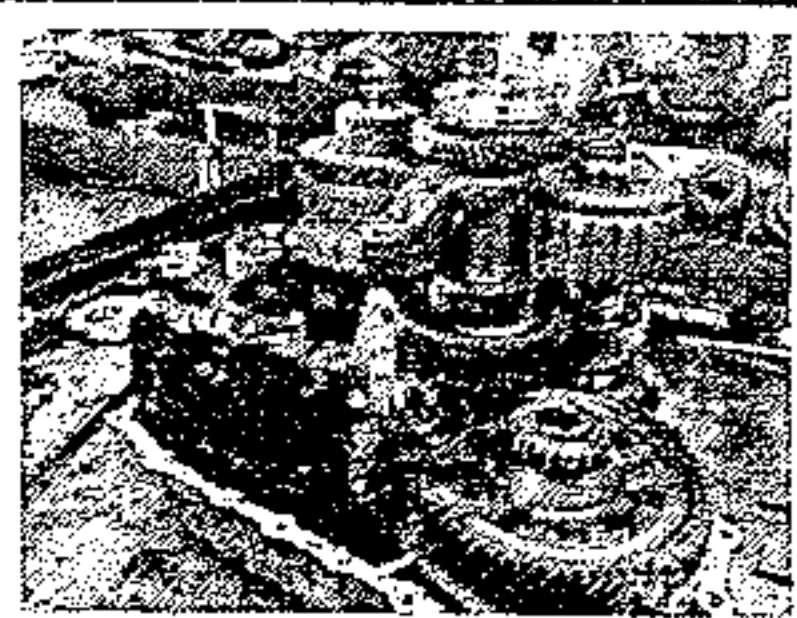

302 S. Northshore Drive Knoxville

(865) 584-4391 budget-transmissions.com

Why Buy From Budget?

Free Towing From Lenoir City or Loudon County

20 Years of BBB Zero Customer Complaints Award Member

A+ Plus Rated

Huge Transmission Inventory

Best Technicians Period!!!

Call (865) 584-4391 Today!



Approved Auto Repair



Update

Natasha Ramsey, 23, Sunshine Private Lane Vonore, was charged with, Aggravated Robbery, Kidnapping, Assault, and Rape. Natasha was placed on a investigation hold by Detective Charlie Cosner, after an investigation it was learned the victim, was assaulted in her vehicle unable to leave

was forced to penetrate her own private area, and money was taken off her person without her consent, looking for drugs. After the investigation Detective Charlie Cosner LCSO, charged Natasha with the charges.

GS cont. from pg. 4

Some of the things The Good Shepherd Center provides are food to over 2,100 men, women and children every month, per-

sonal care items as requested, clothing to each person per household, miscellaneous items each month, transportation via ETHRA for medical appointments, emergency housing for fire victims, layette sets for newborn babies and utility vouchers.

The Good Shepherd Center is supported financially by churches, local businesses, and individuals. Additional funds are provided through grants, auxiliary groups, Monroe County governmental agencies and fundraising

events such as this Dinner/Auction event.

THP cont. from pg. 2

a total of 4 people involved in the crash 2 in the silver vehicle and 2 in the green vehicle. While Trooper was talking with Warren at the hospital he ask Warren how much he had to drink and if he had taken any med-

ication. Warren stated he had 3 beers which confirmed Trooper finding at the scene. Warren stated he had taken his medication, Xanax, Oxycodone, Morphine, and others. Due to injuries Warren was unable to perform sobriety test and was advised he was under arrest. Warren did submit to blood draw for testing. Due to the serious bodily injuries to Warren's passenger and the 2 people in the other vehicle involved, Warren was charged with Vehicular Assault. Trooper Rodney Best THP, made the arrest.

Obituaries

Jimmy "Jim" Russell, 69, of Loudon, passed away suddenly, Sunday, March 20, 2016, at his home. Jim served in the U.S. Army during Vietnam. He was active in the American Legion and the VFW. He spent 30 years as manager of Morrison's Cafeteria and retired from J.T.E.K.T. Corporation. Preceded in death by parents, Elmer and Viola Russell; his wife, Peggy Morelock Russell; brother, Sidney Russell; granddaughter, Hope Yarber; and great granddaughter, Skyla Yarber. He is survived by daughters, Regina and Jess Brooks, and Theresa Smith; sons, Gary Cloyd and Jason and Karen Smith; six grandchildren; several great grandchildren; and several cousins, nieces and nephews. Funeral service 7 pm Tuesday, Loudon Funeral Home Chapel, with Rev. Gary Cook officiating. Family and friends will meet at 1 pm Wednesday at Simpson Cemetery for graveside service. Military honors provided by the Loudon County Veterans Honor Guard. Family will receive friends 5 - 7 pm, prior to the service, at Loudon Funeral Home. www.loudonfuneral-home.net

PURDY'S AUTO PARTS AND SALVAGE
WE BUY SCRAP IRON • COPPER • BRASS • ALUMINUM

\$ **Paying Top \$\$\$**
Call For Latest Prices

You Name It, We Buy It!

Radiators, Wheels, Batteries, Appliances, Farm Equipment

Copper
Paying Top \$\$\$
Call For Latest Prices

You Call We Haul!
423-519-5402

* Prices subject to change with the market.



423 337-3977
149 County Road 323 Sweetwater

Complete Cars
per 100 lbs.

Scrap Metal
Paying Top \$\$\$
Call For Latest Prices
per 100 lb

We Buy Batteries

Aluminum Cans
Paying Top \$\$\$
Call For Latest Prices

Now Selling
Aftermarket
Body Parts at
Discount Prices

* Prices subject to change with the market.

indicted

ATM withdrawals of band booster funds and kept the money for her own benefit. Ms. Krantz admitted to investigators that she used these funds for her house payments.

After meeting with investigators, Ms. Krantz remitted \$3,180 to the band boosters to replace the funds she had taken.

In March 2016, Tracy Krantz was indicted by the Cheatham County Grand Jury on one count of theft over \$1,000.

"Many of the booster club thefts that we investigate can be prevented with better oversight," said Comptroller Justin P.

Wilson. "In this case, separating money handling responsibilities between individuals, and having other officers review bank statements could have detected problems."

Cheatham County Central High School Band Boosters is no longer an active organization. A new booster club named Cheatham County Central Band Boosters has been cre-

ated. The officers of this organization indicate they will follow applicable laws and school support organization procedures in order to prevent similar problems within their new booster club.

To view the special investigation online, go to: <http://www.comptroller.tn.gov/ia/>.

If you suspect fraud, waste or abuse of public money in Tennes-

see, call the Comptroller's toll-free hotline at (800) 232-5454, or file a report online at: www.comptroller.tn.gov/hotline. Follow us on twitter: @TN-COT

Henry County Receives Clean Audit Report

The Tennessee Comptroller of the Treasury is recognizing a significant achievement by Henry County government leaders and elected officials.

Henry County's audit report for the fiscal year ending June 30, 2015 contains no audit findings. Only five Tennessee counties audited by the Comptroller's Office can claim this distinction.

Henry County's pre-

vious annual audit included three findings, all of which have been corrected. Leaders have made a commitment to identify and reduce risk through a strong system of internal controls.

"I applaud everyone associated with Henry County government for this excellent report," Comptroller Justin P. Wilson said. "Henry County joins a select group of Tennessee counties that can claim to have one of the strongest systems of county government in the state."

The Tennessee Comptroller's Office audits 89 of Tennessee's 95 counties. Henry County joins Weak-

see audit ctd. pg. 8

Public Notice
The Loudon County Corrections Partnership Committee will meet March 30, 2016 at 12:00 at the Justice Center to discuss future plans.

LOOK! \$75 Weekly Payments LOOK!

MARTY'S AUTO SALES • 986-2222 • MARTY'S AUTO SALES • 986-2222 • MARTY'S AUTO SALES • 986-2222 • MARTY'S AUTO SALES • 986-2222 • MARTY'S AUTO SALES • 986-2222

Bad Credit
Divorce
Fixed Income
Repos
Bankruptcy
No Credit



APPROVED!

NO CREDIT CHECKS

Visit Us On The Web At:
martyautosales.net

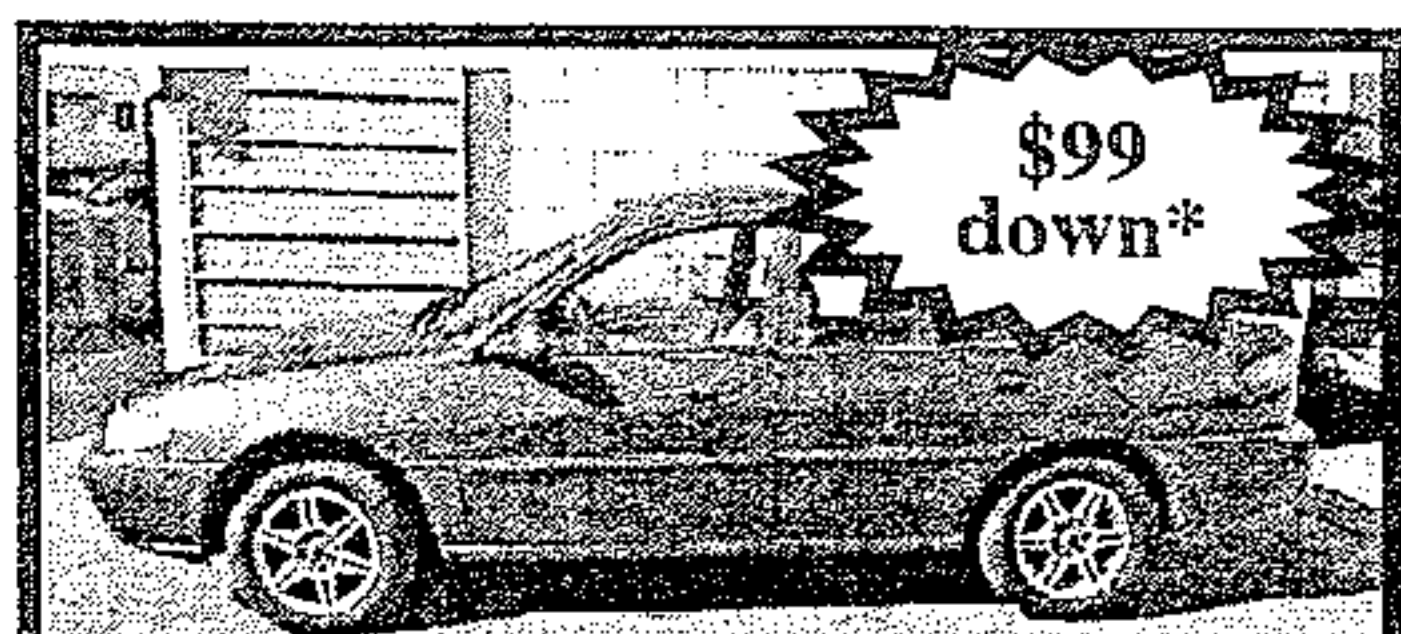

\$99 down*

97 Escort, auto, gas saver
Only \$99 down *



\$299 down*

03 Taurus, runs good, Only
\$299 down *



\$199 down*

99 Venture, 7 passenger,
Only \$199 down *

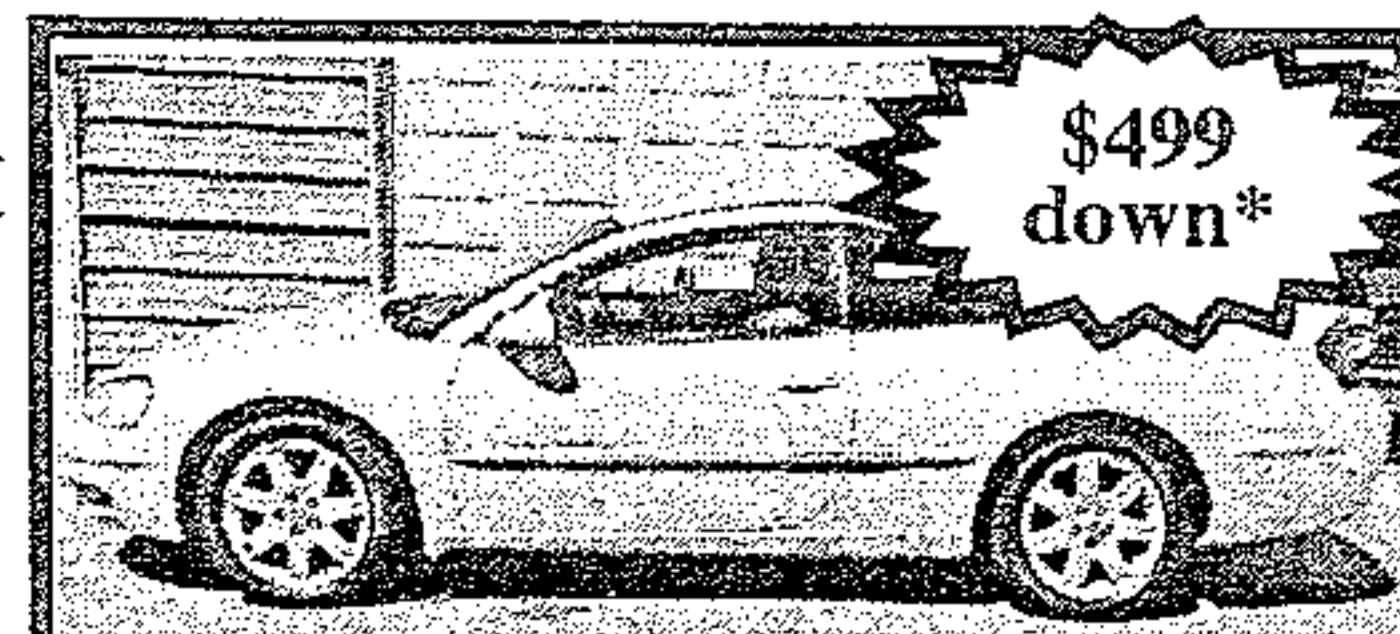

\$499 down*

01 Sebring 2dr. sporty, Only
\$499 down *

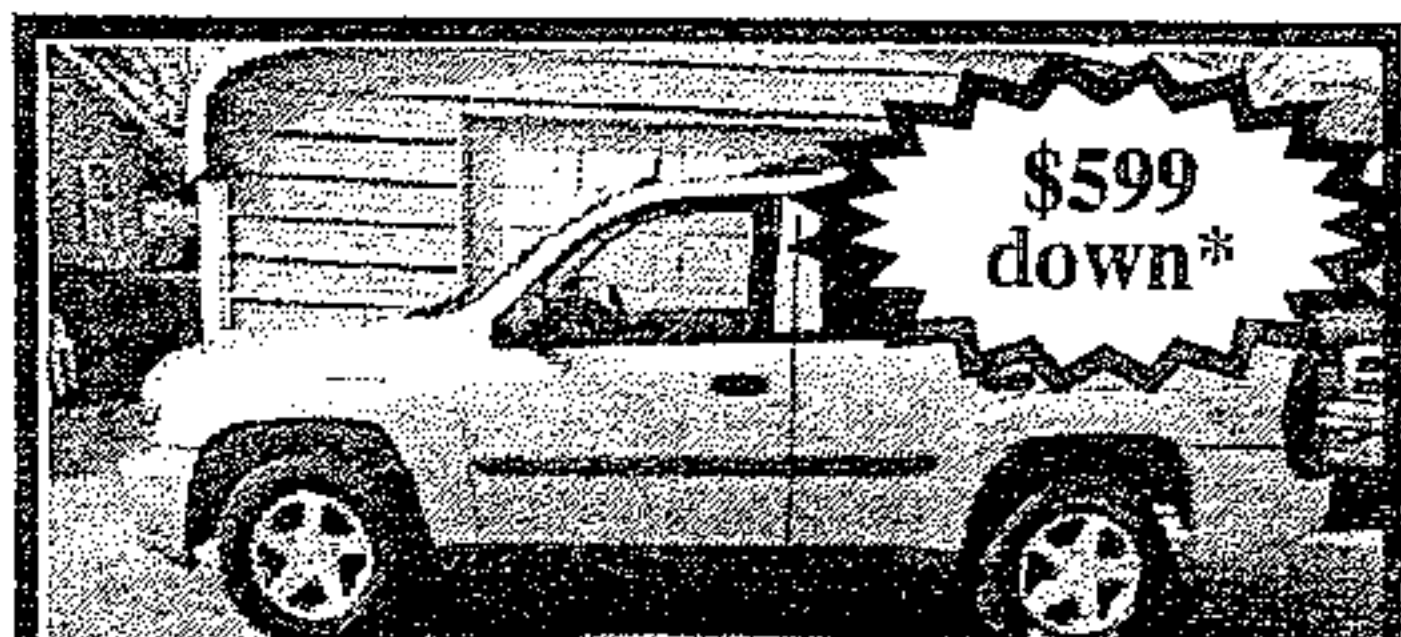

\$599 down*

05 Trailblazer, auto, good
miles Only \$599 down *



\$499 down*

04 Aveo, auto, gas saver,
Only \$499 down *

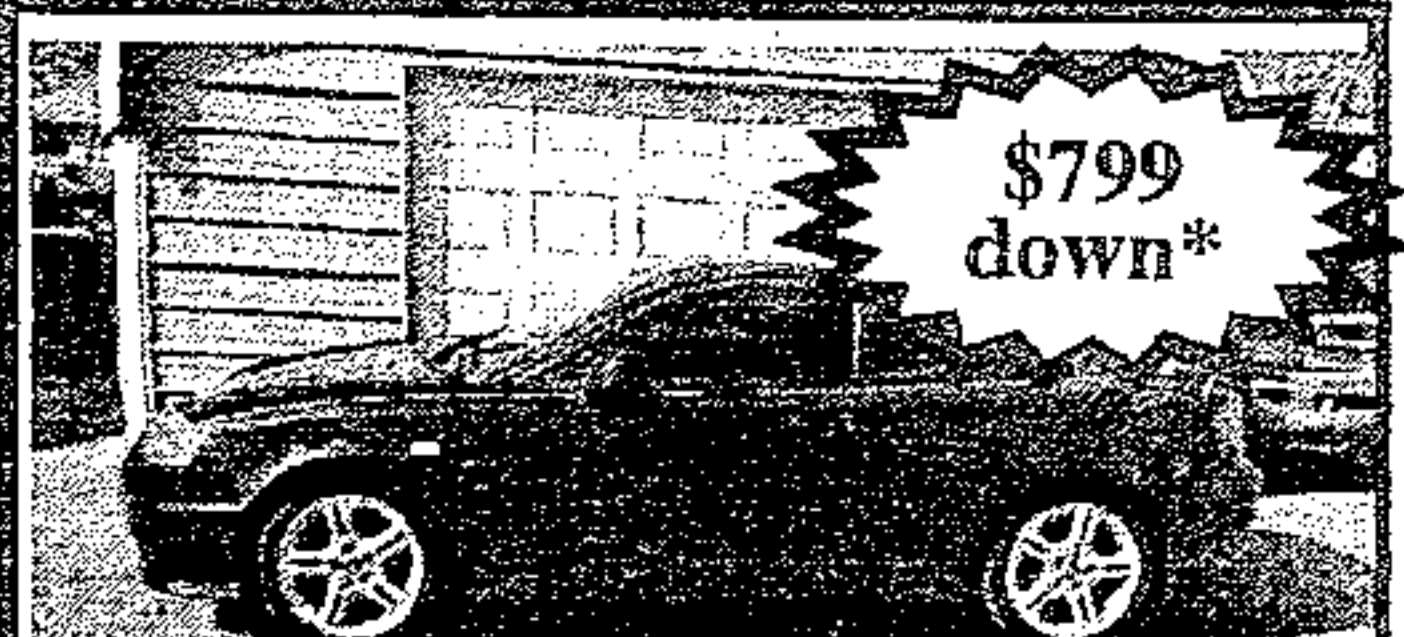

\$799 down*

06 Tiburon GT, 5 speed,
sporty, Only \$799 down *

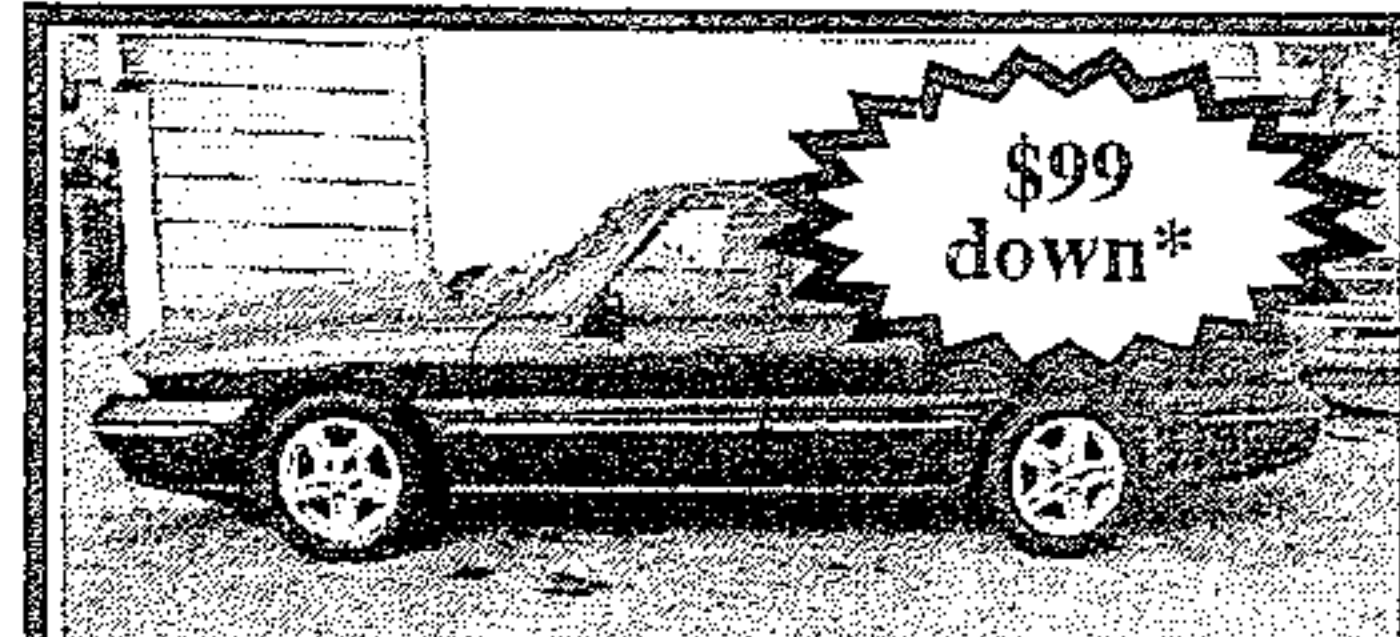

\$99 down*

98 Bonneville, 6 cyl, Auto, low
payments only \$99 down *

NO Credit Checks

Marty's Auto Sales
986-2222

Se Habla Espanol

100% Approval*

*See Dealer for details. All down payments plus tax, tag, title and fees.

MARTY'S AUTO SALES • 986-2222 • MARTY'S AUTO SALES • 986-2222 • MARTY'S AUTO SALES • 986-2222 • MARTY'S AUTO SALES • 986-2222 • MARTY'S AUTO SALES • 986-2222

audit ctd. from pg. 7

ley County, Sullivan County, Blount County and Tipton County as the only counties who have received clean reports in fiscal year 2015.

View the full Henry County Audit Report

at <http://www.comptroller.tn.gov/la/>

If you suspect fraud, waste or abuse of public money in Tennessee, call the Comptroller's toll-free hotline at (800) 232-5454, or file a report online at: www.comptroller.tn.gov/hotline. Follow us on twitter: @TNCOT

on twitter: @TNCOT

A Name You Already Know And Trust Just Got Even More Dependable
DEPENDABLE AUTO SERVICE, LUBE AND TIRES
is Now Offering
Expert, Affordable Transmission Service
 All ASE Certified Technicians

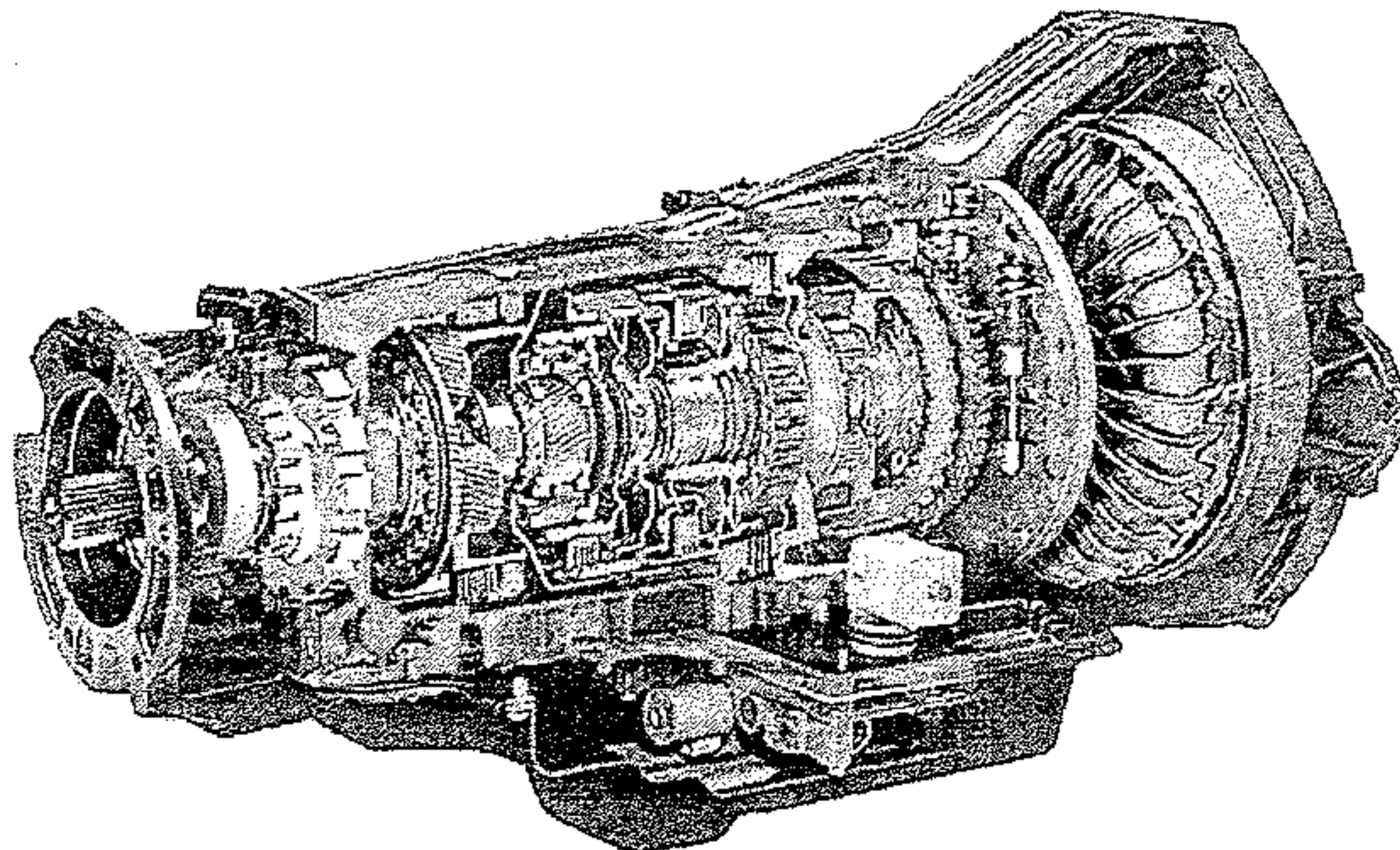

We proudly welcome all New Customers and Former Advanced Transmission Customers with a 10% Discount and Any Transmission Service or Repair*

865-986-9359

865-986-5050

Is Your Washer Broken?

Call Me
 I Only Charge \$100 Period!!!
 Call Allen
 865-617-7113

THE RELIC SHOP

521 Hwy 321 Lenoir City Suite 3
 next to Stained Inc and the Inn of Lenoir
 865-250-9280

HUGE NEW SELECTION OF FOSSILS, ARTIFACTS,
 COINS, AND MORE

ALL AMETHYST 40% OFF

GREAT SELECTION OF ANCIENT MEGALODON
 SHARK TOOTH OVER 8 MILLION YEARS OLD

Bad Credit, No Credit OK!!! We Finance Everybody!!!

Taxes Done Here!!! Bring your last pay stub or W2 and DRIVE TODAY!!!

Over 100 Cars, Trucks & Vans in Stock - Warranties On ALL Vehicles Sold!!!



2007 Chevrolet Uplander, 60k miles, NICE!!!

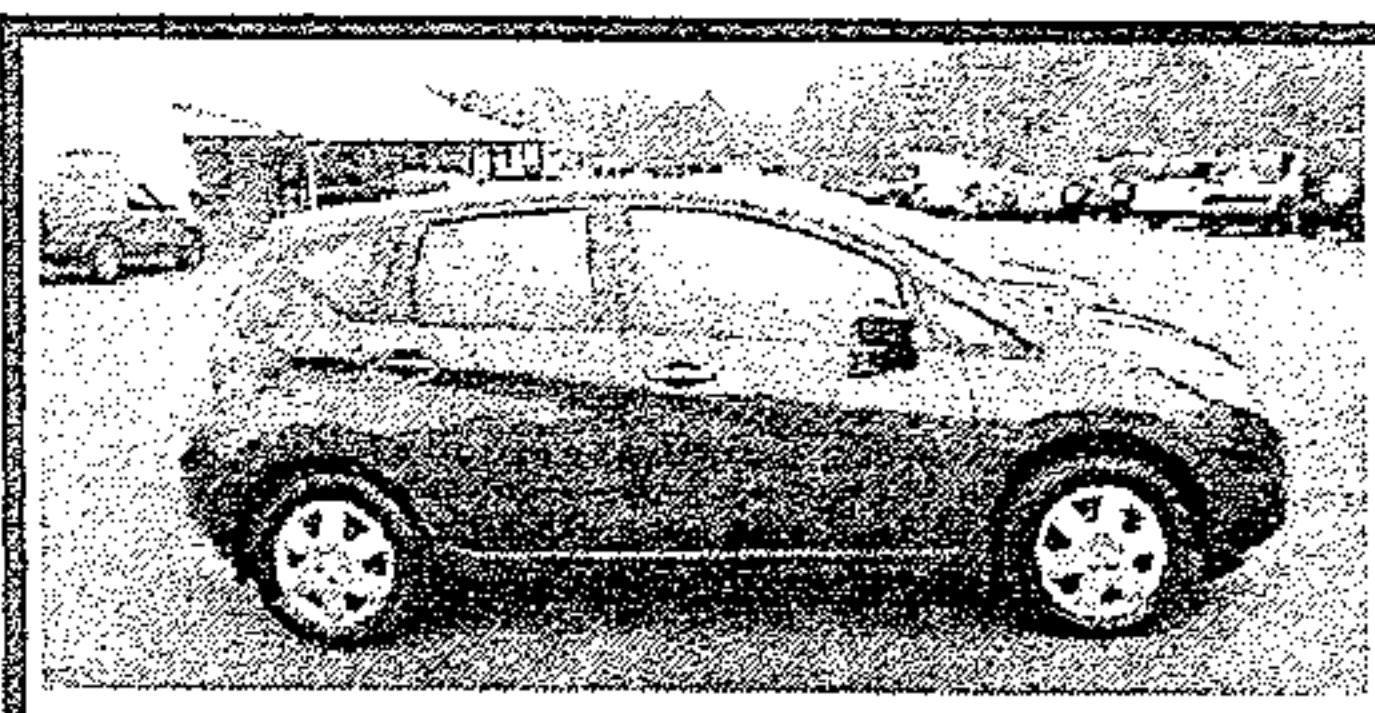

2015 Nissan Versa Note, Factory Warranty, Low Miles

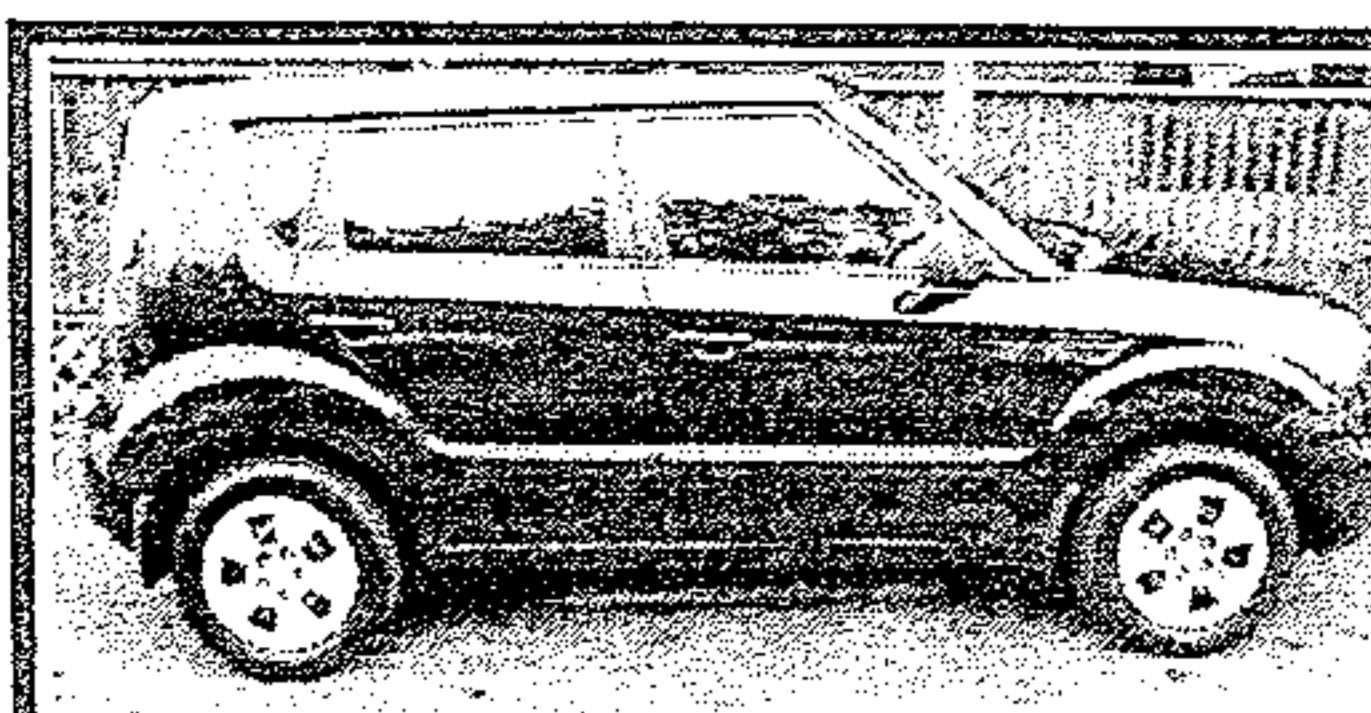

2011 Kia Soul, 5 speed, 4 dr, Gas Saver, Nice & Clean



2008 Saturn VUE, LOADED!!! 4dr, Ready to go on a trip!

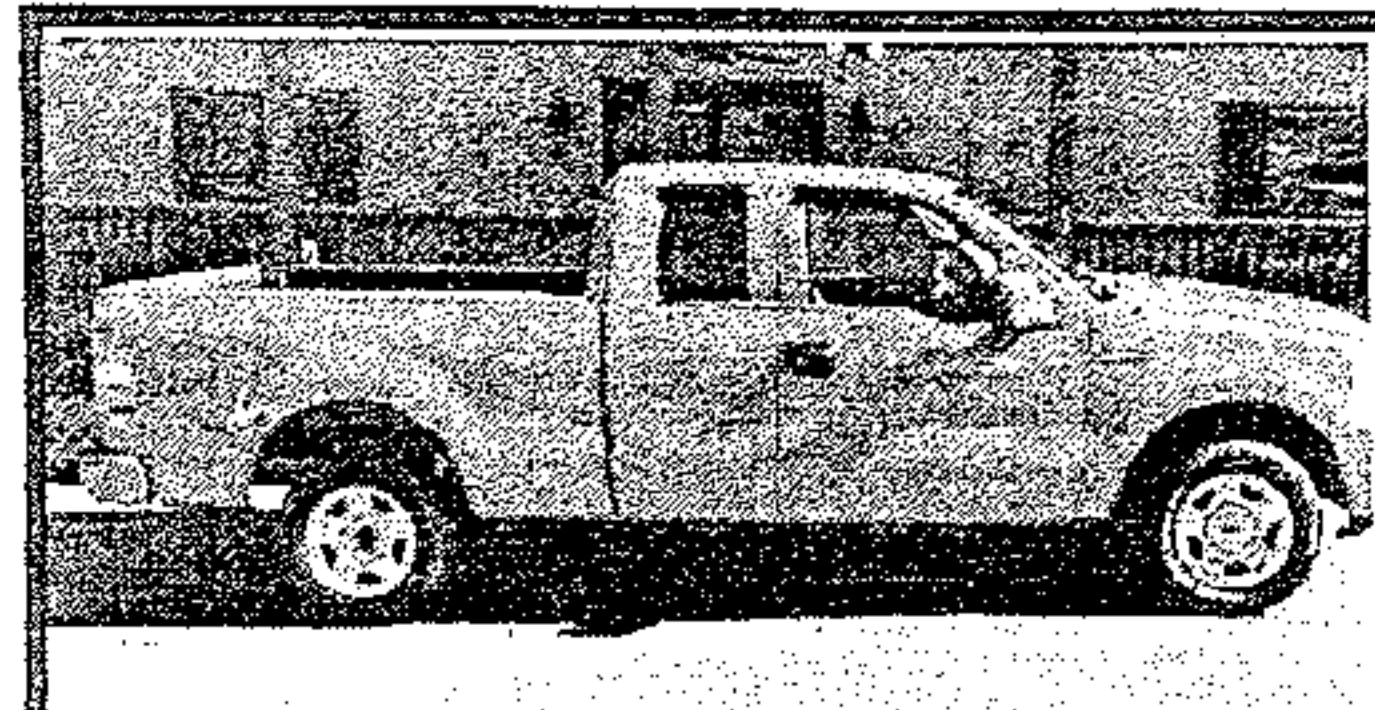

2007 Ford F150, Extra Cab, Clean, Nice Truck

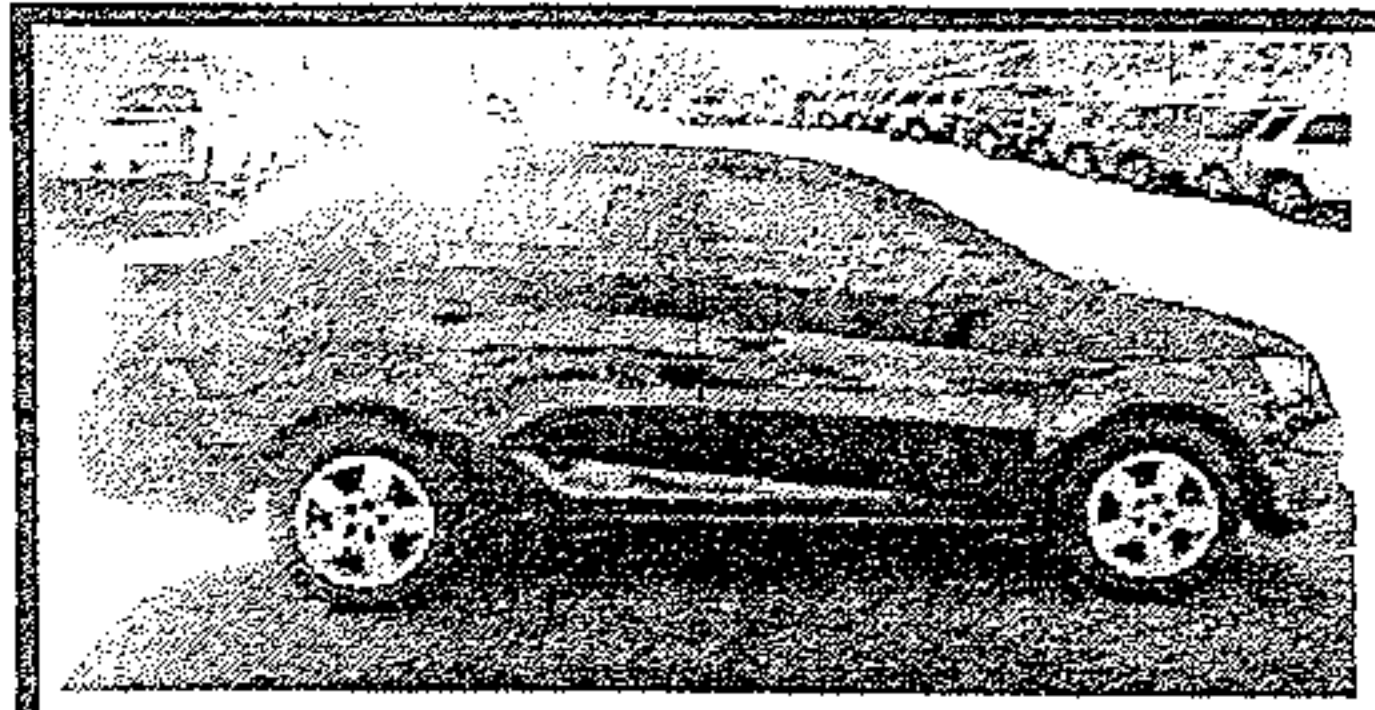

2014 Chevy Sonic, Factory Warranty, Low Miles!



Mitsubishi Raider, Ext. Cab, Super Nice Truck

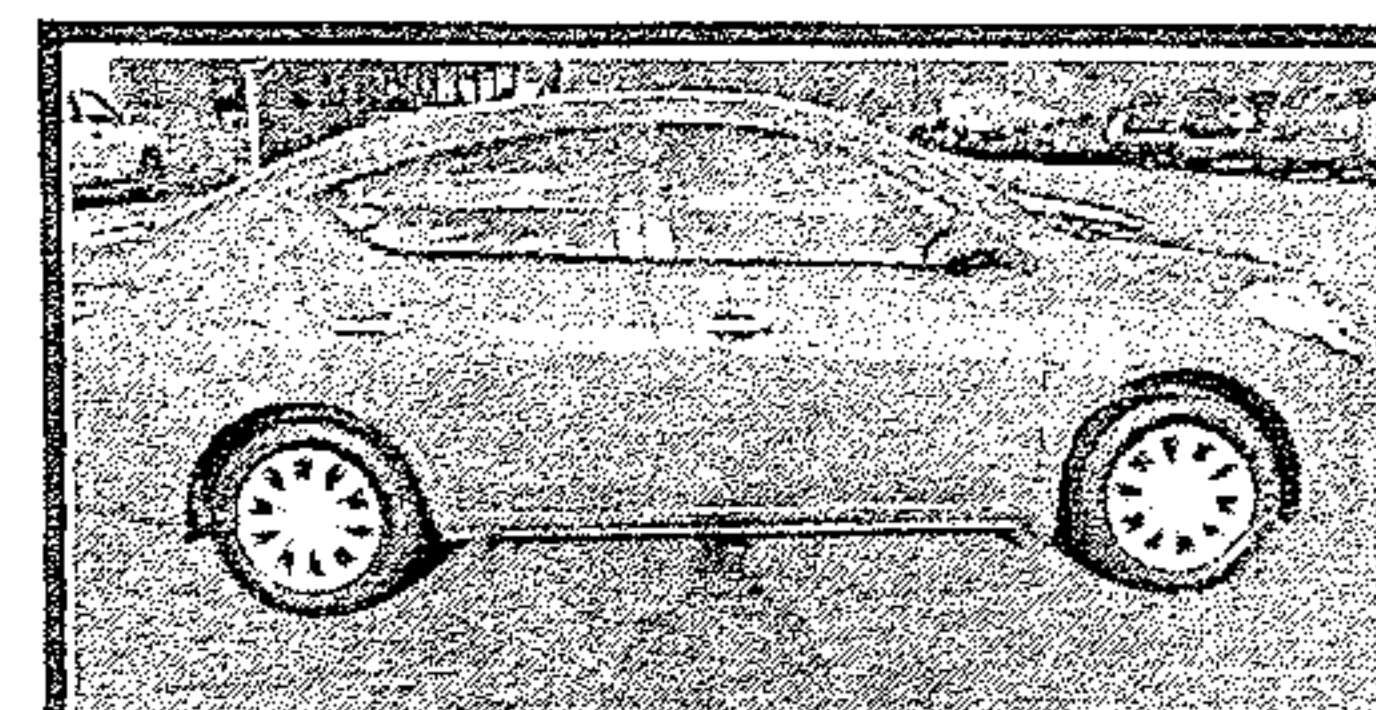

2013 Nissan Versa, Like New! LOADED!!!

WALT WILLIAMS, INC.

*with approved credit

3003 Highway 11 Lenoir City, TN **865-986-1111**