

# The Daily Edition

50¢

Serving Loudon, Monroe and Surrounding Counties

Monday, March 21, 2016

## Man charged with beating up mom Again!

Daltone Major, 34, Bell Street Loudon, was charged with Domestic Assault. Officer Jonathan Yates LPD, responded to a domestic violence at Gay Street in Loudon. Upon arrival Officer was let in the residence by a juvenile who stated he was hurting his mom. Officer could hear a loud commotion coming from the bedroom and command all parties to come out to  
*(see Assault pg. 2)*

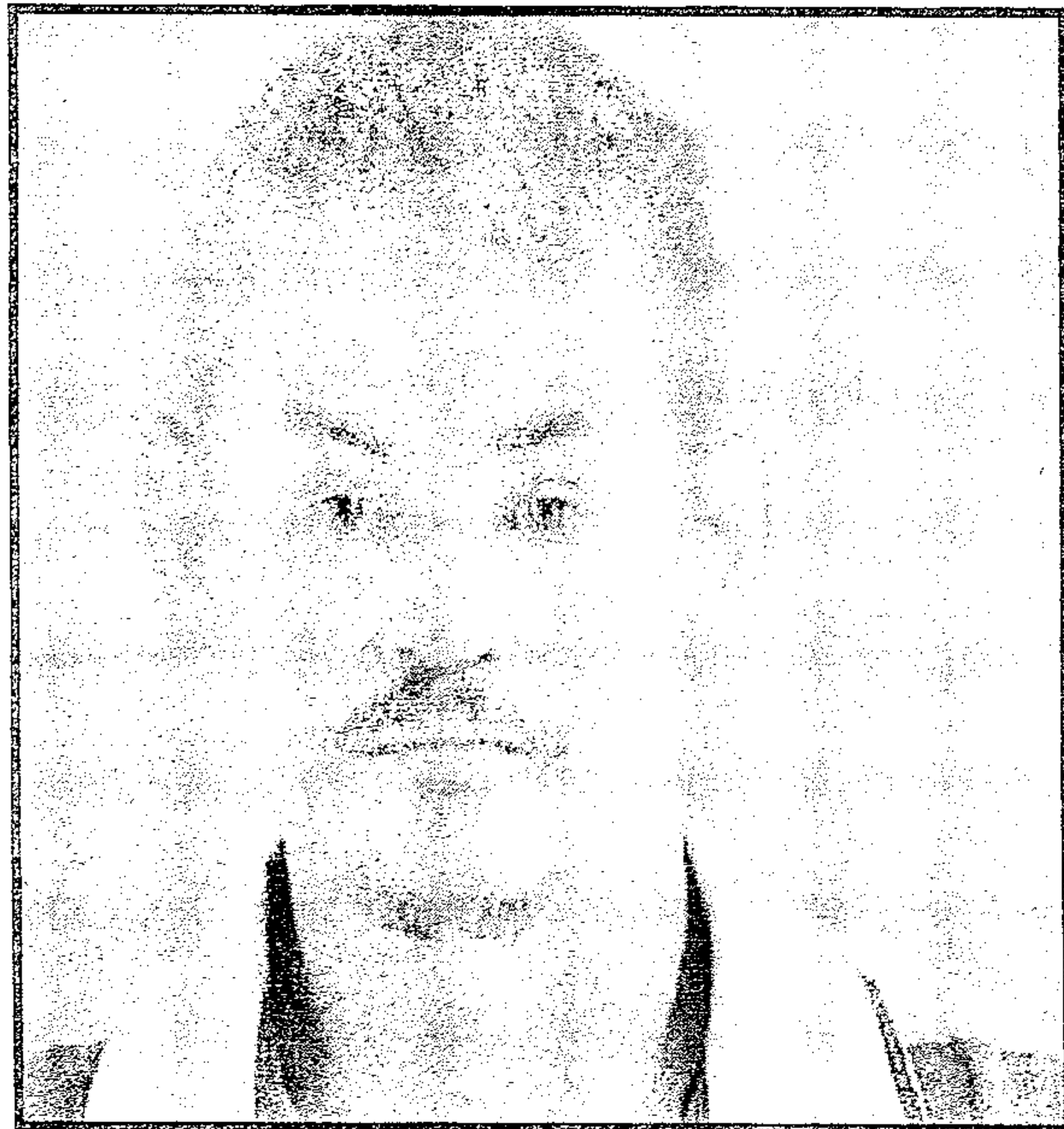

Daltone Major

## Light law violation bad for revoked driver

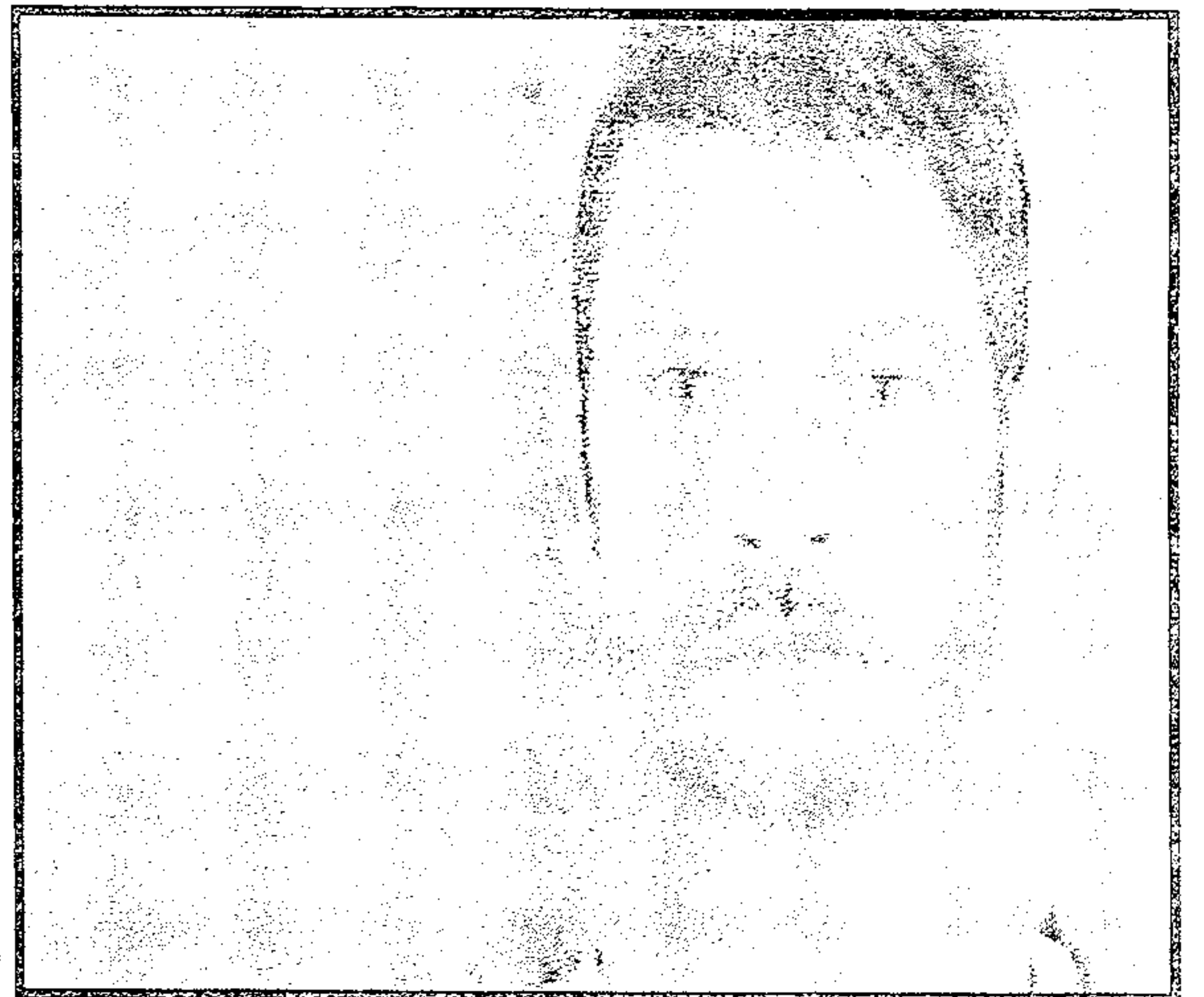

Kenneth Loveday

*(see DUI pg. 5)*

## Felony Charges filed on Villager after mystery bruises on victim appear to be abuse

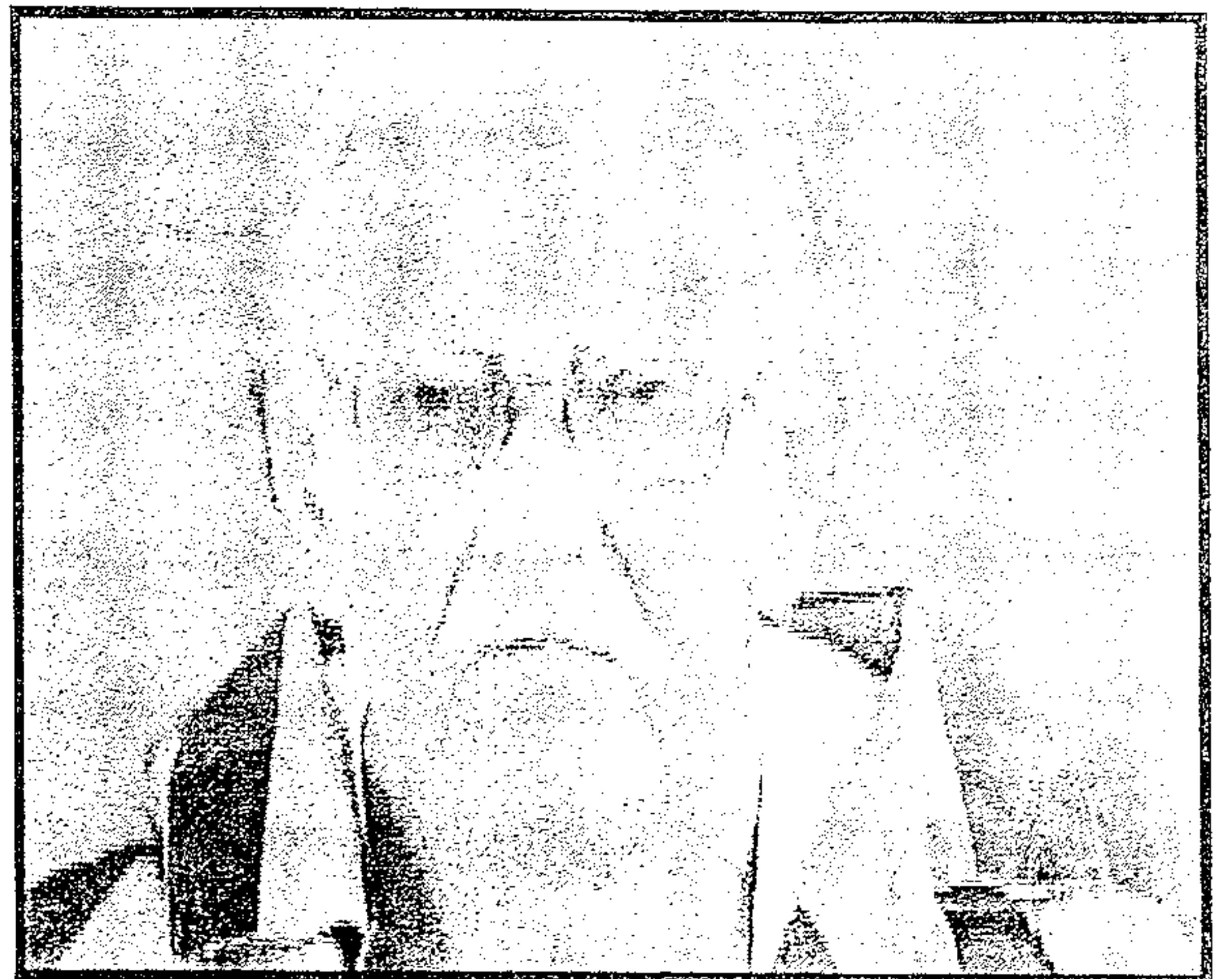

Ronald Kodidek

*(see abuse pg. 3)*

## Check-Cashing Scheme Voided

Multi-Agency Effort Disrupts U.S. Treasury Check-Cashing and Identity Theft Ring

The treasury checks were meant for military families, taxpayers receiving refunds, and Social Security beneficiaries—but they wound up in the hands of thieves instead.

From June 2012 to September 2014, a band of 19 criminals in Atlanta ran a large-scale U.S. Treasury check-cashing and identity theft ring

*(see scheme pg. 7)*

## Arkansas Drug Trafficking Enterprise Dismantled

Leader Gets 20 Years in Prison After Multi-Agency Investigation

Several years ago, in the city of West Memphis in eastern Arkansas, violent street gangs involved in drug trafficking and other crimes threatened the safety and security of the people who lived and worked in the area. One of the most significant gangs was headed by drug kingpin Rafael McDaniel.

After a request for federal assistance  
*(see FBI pg. 4)*

## Verse of the Day

Christredeemed us from the curse of the law by becoming a curse for us, for it is written: "Cursed is everyone who is hung on a tree." — Galatians 3:13

## Obituaries

see inside

## Wazzup

It's Easter Week This Week So REMEMBER The REAL Reason for the season! Spend time with family and be truly

thankful for all you have.

## Weather

Today: Generally sunny despite a few afternoon clouds. High 57F. Tonight: Clear. Scattered frost possible. Low 34F. Tuesday A mainly sunny

sky. High 68F.

Tuesday Night A mostly clear sky. Low 46F.

## Horoscopes

Aries 3/21-4/19

Your eagerness is bubbling over now that the Sun has returned to re-

*(Continued on page 6)*



3 08805 93489 2



assault  
the living room.

A male and female came out and said the assailant Dalton Major was hiding in the closet. Officer found Dalton hiding in the closet and had a steak knife in his pocket.

Officer has responded to several domestic between the parties. Victim had an active

Order of Protection against Dalton. Victim stated Dalton had placed his hands on her and threw her to the ground.

Dalton was placed under arrest. Officer Jonathan Yates LPD, made the arrest.

**Dependable Motors**  
865-986-9343

**Call 865-771-2249 to Advertise and start saving today!**  
**Has your group got an event coming up?**  
**Let us know!!!**

**To Get a Burning Permit:**

Loudon (865) 986-8395  
Monroe (423) 442-7401  
Roane (865) 354-1054

Notice: The Daily Edition does not knowingly accept fraudulent or misleading materials. The Daily Edition cannot guarantee the validity of offerings or statements contained herein. All liability for the contents of all advertising, and for any claims that may arise therefrom, is the responsibility of the advertiser or its agency. The Daily Edition reserves the right to reject, edit, or abbreviate any advertisement submitted. Advertising is accepted with the understanding that all liability for all copyright violations is the sole responsibility of the advertiser. Photographs, artwork and other copy submitted for publication is considered the sole property of the advertiser. The Daily Edition will make every effort but will not be liable for failure to publish and ad or for typographical and layout errors. All statements and information about highlights featured items, letters to the editor, herein are those solely given to the interviewer or writer and the Daily Edition assumes no responsibility of the accuracy or validity thereof. The Daily Edition will gladly reprint at no charge that part of an advertisement in which an error occurs provided a claim is made within 3 days of the first publication of the ad. Information contained in the Wazzup is received anonymously and the Daily Edition assumes no responsibility for information and reserves the right to edit or reject any and/or all submissions. The Daily Edition is a daily newspaper of general circulation in Loudon County defined under TCA 2-1-104(a)(13). The Daily Edition also serves Monroe, Knox, Anderson, Roane and Blount counties and serves 30,000 readers weekly. Send mail to PO Box 1240, Lenoir City TN 37771. 865-771-2249. email: dan1204us@yahoo.com The Daily Edition is Loudon County's premier public interest and paid advertising paper. The Daily Edition is produced and published daily Monday through Friday and is circulated throughout Loudon County and parts of Monroe and Knox Counties. Display advertising rates \$5.00 per column inch and quantity discounts available. Call for information on upcoming promotions and events.

**HACIENDA Ayala's**  
**Mexican Restaurant**  
Market Dr. \* Lenoir City (In Front of Food City)

**Real Authentic Mexican Food at Affordable Prices**

**BEST MARGARITA**

You've Tried The Rest  
Now Come Have The Best!!!

We Accept ALL Competitors Coupons Outside of Mexico City!!

986-3553



**Good Credit OK • Bad Credit OK • Bankruptcies OK • Repo OK**



2010 Kia Soul Sporty, 4 cyl, Auto, PW, PL, A/C, Great On Gas, Like New



2010 Ford Escape Limited Leather, Alloy Wheels, Heat, A/C, Luggage Rack, 79K,



2007 Dodge Ram 1500 Quad Cab, Thunder Road PKG, 20 in. Wheels, Low Miles, Hemi



2008 Ford Explorer 84k, 3rd Row Seating, Luggage Rack, Tow Pkg, PW, PL



2011 Ford Ranger Low Miles, Tow Pkg, New Tires, A/C, Heat, Bed Liner.



2011 Dodge Grand Caravan DVD, Stow & Go, Loaded, Remote Doors, Rear A/C

**DEPENDABLE MOTORS 986-9343**  
803 E. Broadway • Lenoir City

*Serving Loudon County for 20 Years*

\* WAC. See Dealer for details

Visit our website at: [www.dependablemotorslc.com](http://www.dependablemotorslc.com)



abuse

Ronald Kodidek, 73, In-agehi Circle Loudon, was charged with Domestic Assault Felony.

Deputy Craig Brewer LCSO, was dispatched to

meet with medical personnel from Priority Ambulance at the Fort Sanders Loudon Emergency Room. Upon arrival, Deputy met with a female, a possible victim of domestic violence. She had been sent to the ER by a doctor from UT Family Physicians in Loudon, because of possible signs of abuse. Victim had visible bruises on her face and forehead. She also had bruising on her chest, both shoulders, and left leg and ankle. Victim would not say where the bruising came from, but it was believed by

the doctor to be from her husband, Ronald Kodidek, same address. Victim would not cooperate with the investigation. Deputy spoke with her husband, who stated that the injuries came from falling. He was not cooperative either. Deputy Craig Brewer LCSO, made the arrest.

**For Sale: Oak Wood Mulch**

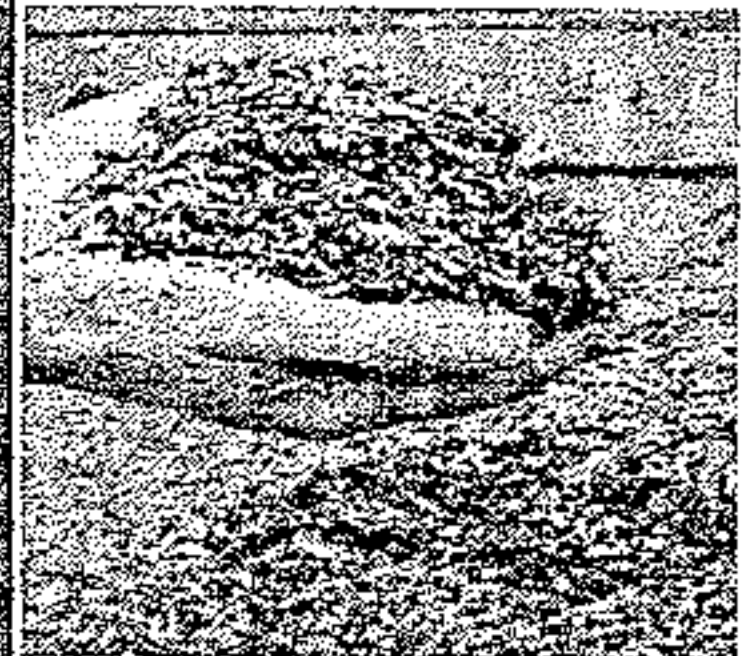

Mushroom Compost Topsoil.

**Firewood**



Call Steve Spoon 986-4282

**The Daily Edition**

serving Loudon and surrounding counties since 1986

**C&C Lawn Care**  
Mowing, Mulching, Trimming, Edging, Clear Debris  
Free Estimates  
Call Chad 865-271-8070

**West End Storage & Warehouses**  
502 Ward Avenue • Loudon  
Call 865-458-4774 or 865-679-5555

**STAINED INK**  
**TATTOO & PIERCING**  
LENOIR CITY 865 816-6440  
NEW OWNER • NEW ARTIST • SINCE 2011  
521 Hwy 321 next to Vape & Stuff & Inn Of Lenoir!  
Clean-Affordable-Quality-Custom  
Tattoo's You've Always Wanted!

BRING IN THIS AD FOR **\$25 OFF**  
NEW INK FOR NEW CUSTOMERS ONLY!

Check us out on FB.com/  
Stained.Ink.Tattoo/  
www.STAINEDINK.com

**BIMBO'S**  
Deli Open 24 Hours  
865-986-9643 Call Ins Welcome  
Specials  
Lg. Cold Sub, bag of chips and 16 oz. fountain drink  
only \$6.29  
Footlong Corn Dog \$2.59

**C&J Towing and Recovery**  
LOWEST TOWING RATES AROUND!!!

Have you been overcharged for any type of towing service in the Lenoir City area? If you have a breakdown or accident please OWNER REQUEST C&J Towing with the officer. Also please call your Sheriff and ask him to place C&J Towing on the "Rotation List\*" and help other motorists save as much as you did! We at C&J are locally owned and operated, State approved, licensed, bonded and insured. Call and let us know if your denied service or how we can be of assistance.

\*note: the "Rotation List" is a list of wrecker services that provide service for wrecks, DUI's, breakdowns, etc. and are on an on-call basis for service. This list is approved by the Sheriff.

Cliff Teeters • Owner  
865-809-1661



FBI tance from the West Memphis Police Department to help address the drug trafficking activity and its accompanying violence, the FBI initiated Operation Delta Crossroads as an Organized Crime Drug Enforcement Task Force (OC-DETF) case. And as a result of the investigation—which involved multiple controlled drug buys and several Title III wiretaps that recorded hundreds incriminating conversations—McDaniel was convicted of drug and firearms offenses last year and subsequently sentenced to a 20-year prison term. Several of his co-conspirators were also charged, pled guilty, and sentenced. The OCDETF program, established in 1982, is the centerpiece of the Department of Justice's drug strategy to reduce the availability of drugs by identifying, disrupting, and dismantling major drug trafficking organizations and related criminal enterprises. OC-DETF investigations succeed because they leverage the strengths, resources, and expertise of federal, state, and local investigators and prosecutors. During the investigation into McDaniel's gang, agents from our Little Rock Field Office worked side-by-side with several narcotics detectives from the West Memphis Police Department. With the assistance of the Arkansas State Police—and in coordination with the U.S. Attorney's Office for the Eastern District of Arkansas—investigators identified and gathered evidence on McDaniel's West Memphis-based drug trafficking organization, which was believed to be responsible for the distribution of large quantities of cocaine and crack cocaine in Crittenden County and other areas of eastern Arkansas. We knew that McDaniel had two lieutenants—Wendell Glenn and David Green—who helped him run the operation. We knew that the organization regularly obtained multi-ounce quantities of cocaine from suppliers. We knew that McDaniel, Glenn, Green, and others actually converted the cocaine into crack cocaine before giving it to other organization members responsible for the sale of the drugs. And we knew that members of the criminal enterprise, including McDaniel, possessed and used firearms for the purpose of protecting

## JOB FAIR

Tellico Village is a fun, challenging and rewarding place to work. And it's a beautiful location. Tellico Village is holding a job fair on Thursday, March 24th from noon to 4 p.m. at our Welcome Center at 202 Chota Road in the heart of our community. Look for the red job fair signs! We're hiring for golf maintenance, public works and our restaurants in Loudon and Monroe Counties. We hope to see you on the 24th. For information, call (865) 408-2627.

## PUBLIC NOTICE

The Lenoir City Utilities Board is rescheduling their March 2016 Board Meeting which was scheduled for Monday, March 21, 2016, at 4:00 p.m. The new rescheduled time will be Monday, March 28, 2016, at 6:00 p.m. As always, the meeting will be held in the Council Chambers of City Hall located at 600 East Broadway, Lenoir City, Tennessee 37771.

(see FBI ctd. pg. 5)

**BUDGET**  
*Transmissions*



302 S. Northshore Drive Knoxville  
(865) 584-4391 [budget-transmissions.com](http://budget-transmissions.com)

**Why Buy From Budget?**  
Free Towing From Lenoir City or Loudon County  
20 Years of BBB Zero Customer Complaints Award Member  
A+ Plus Rated  
Huge Transmission Inventory  
Best Technicians Period!!!  
Call (865) 584-4391 Today!





## NEED HELP WITH INCOME TAX? PROFESSIONAL TAX SERVICE

**PRICE - 95% of returns between \$60-\$140**

(No Coupons Required)

**LOCALLY Owned & Operated - Open Year Round**

**30+ Years in the business**

**ALL Preparers with 10+ years experience**

**Pro Tax**

**111 E. Broadway**

**Lenoir City, TN 37771**

**Phone 865-986-4035**

*\*US Armed Service Active Duty Personnel, "THANK YOU", Tax Return Free*



**DUI**

Kenneth Loveday, 44, East Scott Avenue Knoxville, was charged with DUI, Driving on Revoked License, Simple Possession, and Poss. of Drug Para. Sgt. Russell Smith THP, conducted a traffic stop at the 80 mm southbound on I-75 for a light law violation, the driver was identified as Kenneth

Loveday. Kenneth was overly nervous during the interview, and stated he did not have a driver license. A check through dispatched revealed his license were suspended and had a larceny warrant from 2004. During a search of the vehicle revealed approx. 3 grams of marijuana, rolling papers in a sunglass holder. Kenneth stated he had smoked marijuana

earlier. Kenneth was ask to perform sobriety test and was unable to perform as instructed. Kenneth was placed under arrest. Sgt. Russell Smith THP, made the arrest.

FBI cont. from pg. 4

their drugs and drug proceeds and to intimidate and deter rival drug dealers. The Little Rock FBI case agent recalled an

instance of overhearing talk on a wiretap between Wendell Glenn and a criminal associate who was physically tailing a rival drug dealer. The associate offered to shoot the dealer, but Glenn said he wanted to do it himself. "But," said the agent, "the shooting didn't happen because we sent marked units to flood the area."

A July 2014 supersed-

ing indictment charged McDaniel, Glenn, Green, and 15 other conspirators with various drug trafficking and firearms offenses. Sixteen defendants, including Glenn and Green, eventually entered guilty pleas and were sentenced in the face of such overwhelming evidence (charges against a 17th defendant were combined with another federal indictment). But McDaniel, perhaps thinking he was smart enough to beat the system, took a chance on a trial—and lost.

Law enforcement collaboration in eastern Arkansas is nothing new—in February 2015, the leader of another drug trafficking organization was sentenced to life in prison after the successful conclusion of another OCDETF case, Operation Delta Blues, which targeted public corruption, drug trafficking, and unlawful firearms. And in August 2015, 70 defendants were charged with drug and gun offenses in 40 separate indictments as part of an OCDETF case known as Operation Blynd Justus.

According to the Delta Crossroads case agent, "The task force made the case. It would not have happened without both agencies [West Memphis Police Department and FBI] working closely together."

And today, communities in eastern Arkansas are enjoying dramatic decreases in violent crimes being committed on their streets as a result of these kinds of law enforcement collaborations.

**PURDY'S AUTO PARTS AND SALVAGE**  
**WE BUY SCRAP IRON • COPPER • BRASS • ALUMINUM**

**\$** **Paying Top \$\$\$**  
**Call For Latest Prices**

*You Name It, We Buy It!*

*Radiators, Wheels, Batteries, Appliances, Farm Equipment*

**Copper**  
**Paying Top \$\$\$**  
**Call For Latest Prices**

**Complete Cars**  
**per 100 lbs.**

**Scrap Metal**  
**Paying Top \$\$\$**  
**Call For Latest Prices**  
**per 100 lb**

**We Buy Batteries**

**Aluminum Cans**  
**Paying Top \$\$\$**  
**Call For Latest Prices**

**You Call We Haul!**  
**423-519-5402**

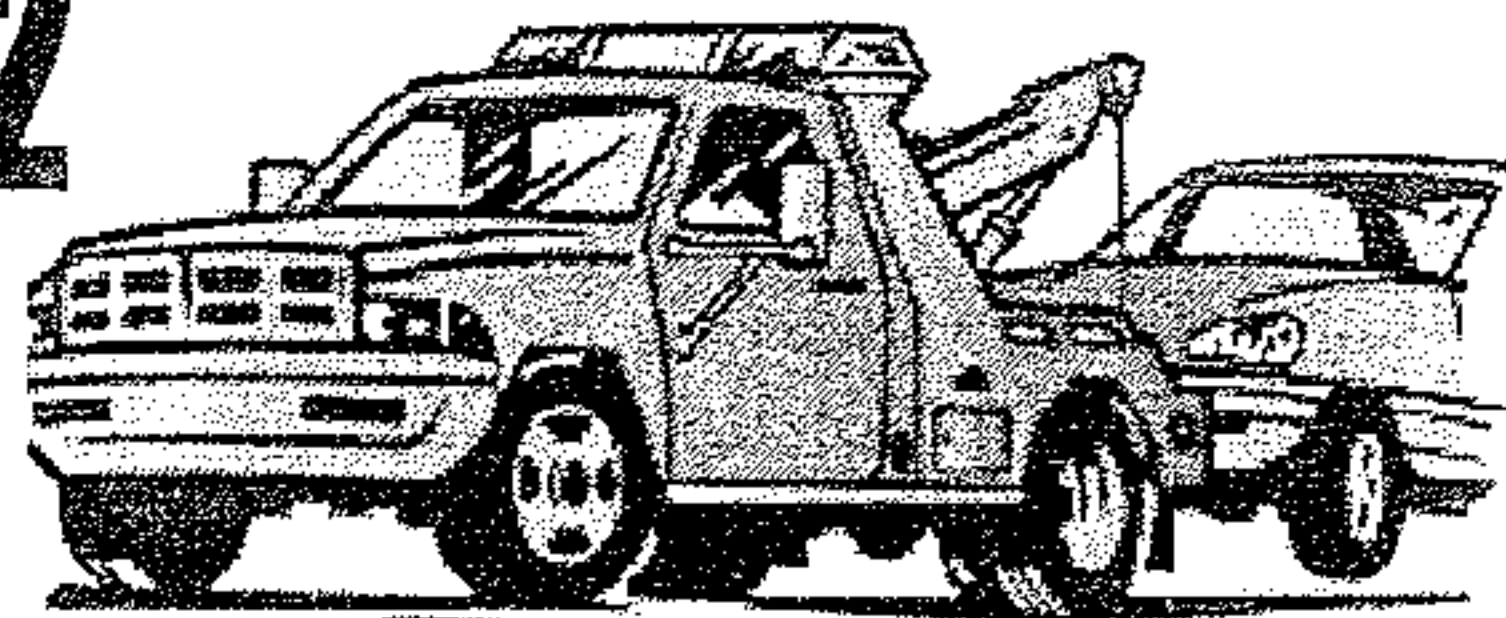

**Now Selling**  
**Aftermarket**  
**Body Parts at**  
**Discount Prices**

\* Prices subject to change with the market.

**423 337-3977**  
**149 County Road 323 Sweetwater**

Prices subject to change with the market.



**scheme**

that defrauded the federal government and retail stores of nearly \$1 million. The ring included check suppliers, sellers, identification manufacturers, and "check runners" who used fake driver's licenses to cash stolen checks.

At the center of it all was career criminal Asad Abdullah, who orchestrated the elaborate scheme from inside a Georgia state prison. With regular access to contraband cellphones, Abdullah was able to contact his younger brothers in Atlanta, and he soon had the resources he needed to mobilize the family-run criminal

**enterprise.**

Here's how it worked: Thieves stole checks from various sources, including the U.S. mail, and middlemen purchased the checks at a percentage of their face value, usually 25 percent. Meanwhile, identification manufacturers were paid to produce counterfeit Georgia driver's licenses matching the names and addresses

of the victims, but with photos of the scheme's check runners, who would cash the checks at grocery stores, discount supermarkets, and check-cashing outlets.

While U.S. Treasury check-cashing was a regular activity for Abdullah's crew, the ambitious enterprise also engaged in credit card fraud. Inside sources working at big-

box stores with regular access to customer and store credit card data provided the thieves with a steady flow of personal information. This data was used to produce counterfeit identification documents so the fraudsters could pose as real store club members. Trips to stores throughout Georgia, Tennessee, and Alabama resulted in brand new replacement credit cards that were ultimately used to purchase gift cards, gas, groceries, and other items.

The ring was finally derailed following a series of early morning raids and takedowns on September 24, 2014, which turned up weapons, cash, and identity

document manufacturing hardware.

"The 16-month investigation was an enormous cooperative effort involving numerous federal, state, and local law enforcement resources," said an FBI Atlanta agent assigned to the case.

As part of the investigation, a confidential informant assisted the FBI and other law enforcement personnel in recovering stolen checks and false identifications. Several stores also agreed to support the investigation by cashing the stolen checks, thus aiding the Bureau and other agencies in identifying members of the scheme.

scheme etd pg. 8

**Public Notice**  
 The Loudon County Corrections Partnership Committee will meet March 30, 2016 at 12:00 at the Justice Center to discuss future plans.

**LOOK! \$75 Weekly Payments LOOK!**

MARTY'S AUTO SALES • 986-2222 • MARTY'S AUTO SALES • 986-2222 • MARTY'S AUTO SALES • 986-2222 • MARTY'S AUTO SALES • 986-2222 • MARTY'S AUTO SALES •

**Bad Credit**  
**Divorce**  
**Fixed Income**  
**Repos**  
**Bankruptcy**  
**No Credit**

**APPROVED!** **NO CREDIT CHECKS**

Visit Us On The Web At:  
**[martysautosales.net](http://martysautosales.net)**

 <p><b>\$99 down*</b></p> <p><b>97 Escort, auto, gas saver</b>                  Only \$99 down *</p>	 <p><b>\$299 down*</b></p> <p><b>03 Taurus, runs good, Only</b>                  \$299 down *</p>	 <p><b>\$199 down*</b></p> <p><b>99 Venture, 7 passenger,</b>                  Only \$199 down *</p>	 <p><b>\$499 down*</b></p> <p><b>01 Sebring 2dr. sporty, Only</b>                  \$499 down *</p>
 <p><b>\$599 down*</b></p> <p><b>05 Trailblazer, auto, good</b>                  miles Only \$599 down *</p>	 <p><b>\$499 down*</b></p> <p><b>04 Aveo, auto, gas saver,</b>                  Only \$499 down *</p>	 <p><b>\$799 down*</b></p> <p><b>06 Tiburon GT, 5 speed,</b>                  sporty, Only \$799 down *</p>	 <p><b>\$99 down*</b></p> <p><b>98 Bonneville, 6 cyl, Auto, low</b>                  payments only \$99 down *</p>

**NO Credit Checks** *Marty's Auto Sales* **986-2222** *Se Habla Espanol* **100% Approval**

\*See Dealer for details. All down payments plus tax, tag, title and fees.

MARTY'S AUTO SALES • 986-2222 • MARTY'S AUTO SALES • 986-2222 • MARTY'S AUTO SALES • 986-2222 • MARTY'S AUTO SALES • 986-2222 • MARTY'S AUTO SALES •



Scheme ctd. from pg. 7

"Fraud and identity theft crimes are a serious problem in Atlanta," added the case agent. "Our combined efforts in this particular case serve as a warning to would-be criminals on the brink of preying on unsuspecting vic-

tims."

Sentencing was announced on February 16, 2016 for 18 of the 19 Atlanta criminals convicted for their roles in the crime ring. The 19th and final defendant is scheduled to be sentenced in the near future.

**Is Your Washer Broken?**

**Call Me  
I Only Charge \$100 Period!!!  
Call Allen  
865-617-7113**

**THE RELIC SHOP**

521 Hwy 321 Lenoir City Suite 3  
next to Stained Inc and the Inn of Lenoir  
**865-250-9280**

HUGE NEW SELECTION OF FOSSILS, ARTIFACTS,  
COINS, AND MORE

**ALL AMETHYST 40% OFF**

GREAT SELECTION OF ANCIENT MEGALODON  
SHARK TOOTH OVER 8 MILLION YEARS OLD

**A Name You Already Know And Trust Just Got Even More Dependable**  
**DEPENDABLE AUTO SERVICE, LUBE AND TIRES**  
**is Now Offering**  
**Expert, Affordable Transmission Service**

All ASE Certified Technicians

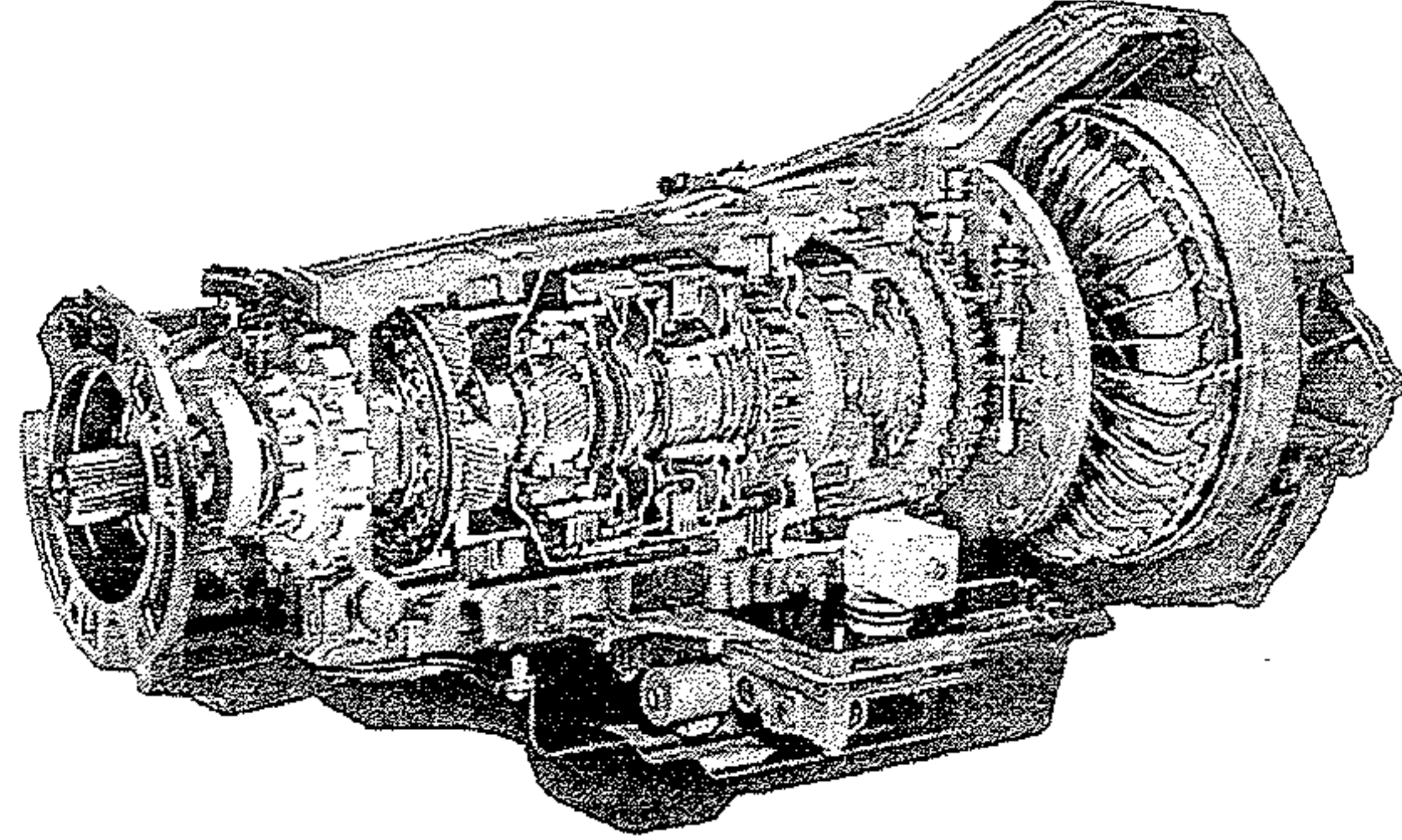

**We proudly welcome all New Customers  
and Former Advanced Transmission  
Customers with a 10% Discount and Any  
Transmission Service or Repair\***

**865-986-9359**

**865-986-5050**

**Bad Credit, No Credit OK!!! We Finance Everybody!!!**

**Taxes Done Here!!! Bring your last pay stub or W2 and DRIVE TODAY!!!**

**Over 100 Cars, Trucks & Vans in Stock - Warranties On ALL Vehicles Sold!!!**



**2007 Chevrolet Uplander,  
60k miles, NICE!!!**

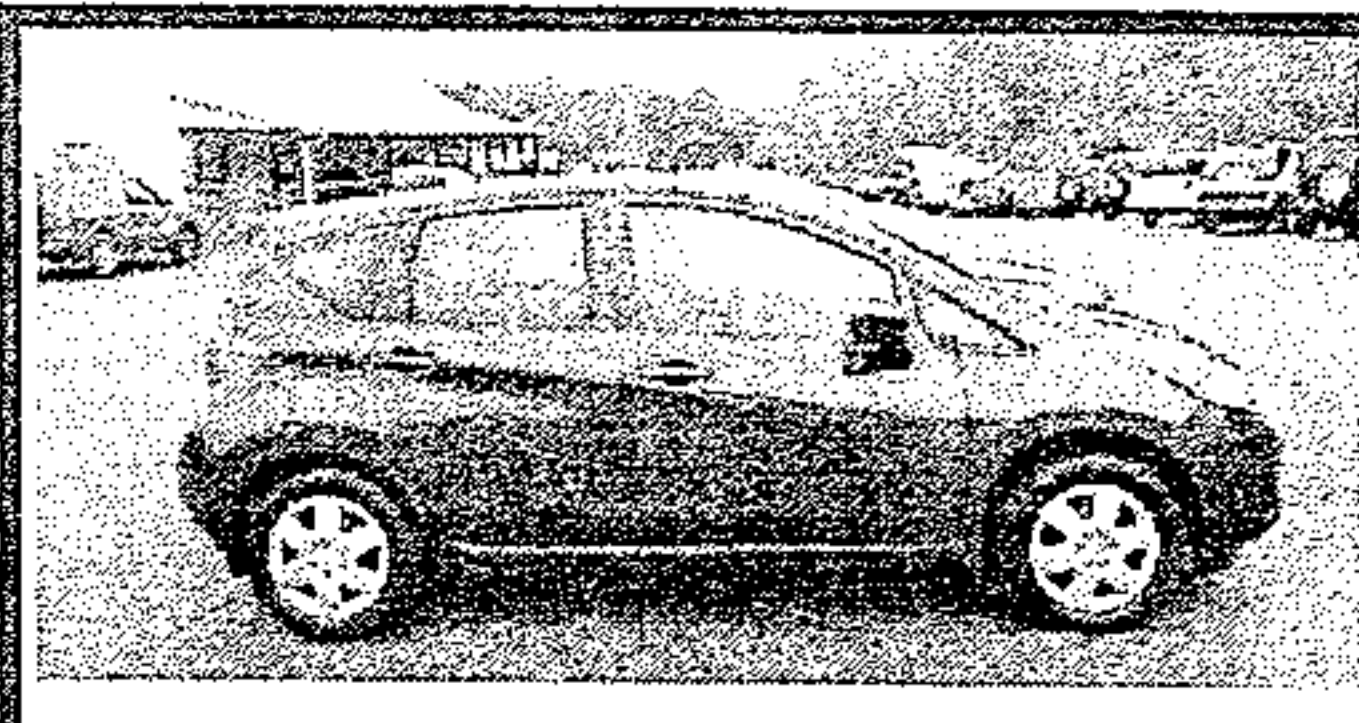

**2015 Nissan Versa Note, Fac-  
tory Warranty, Low Miles**

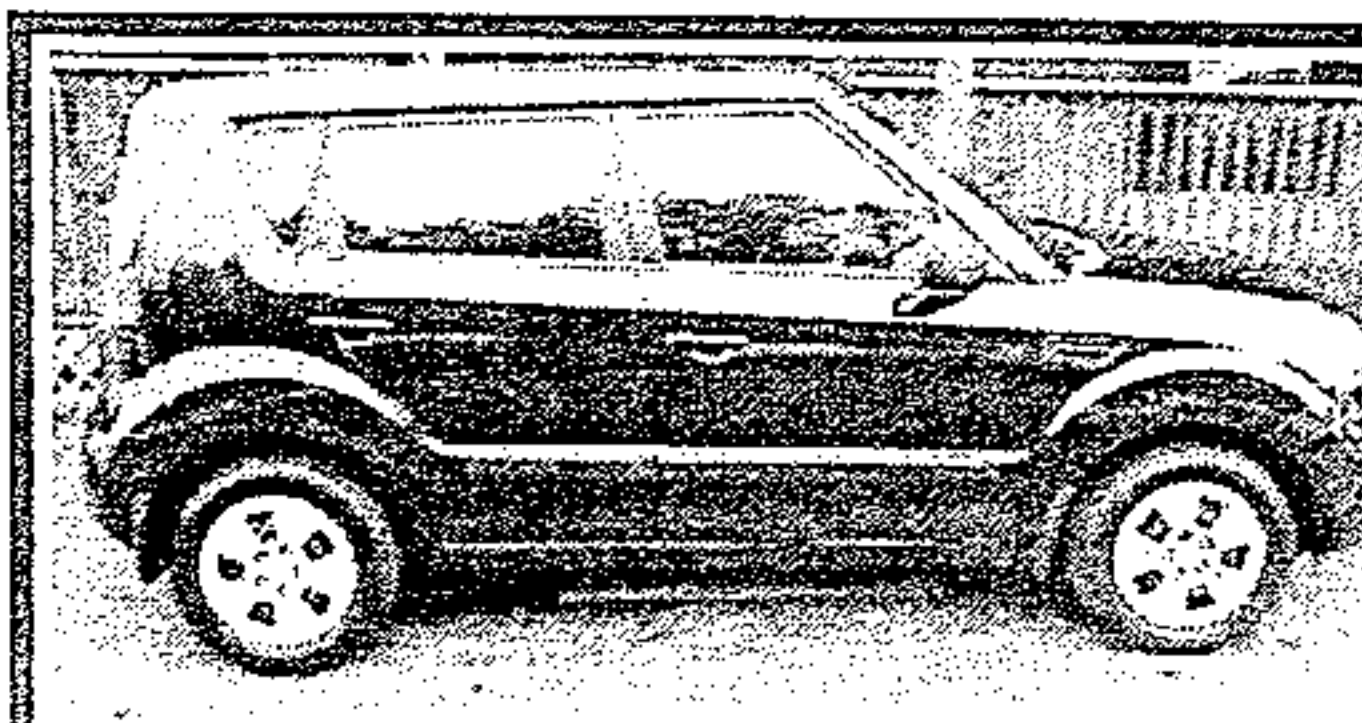

**2011 Kia Soul, 5 speed, 4 dr,  
Gas Saver, Nice & Clean**



**2008 Saturn VUE, LOADED!!!  
4dr, Ready to go on a trip!**

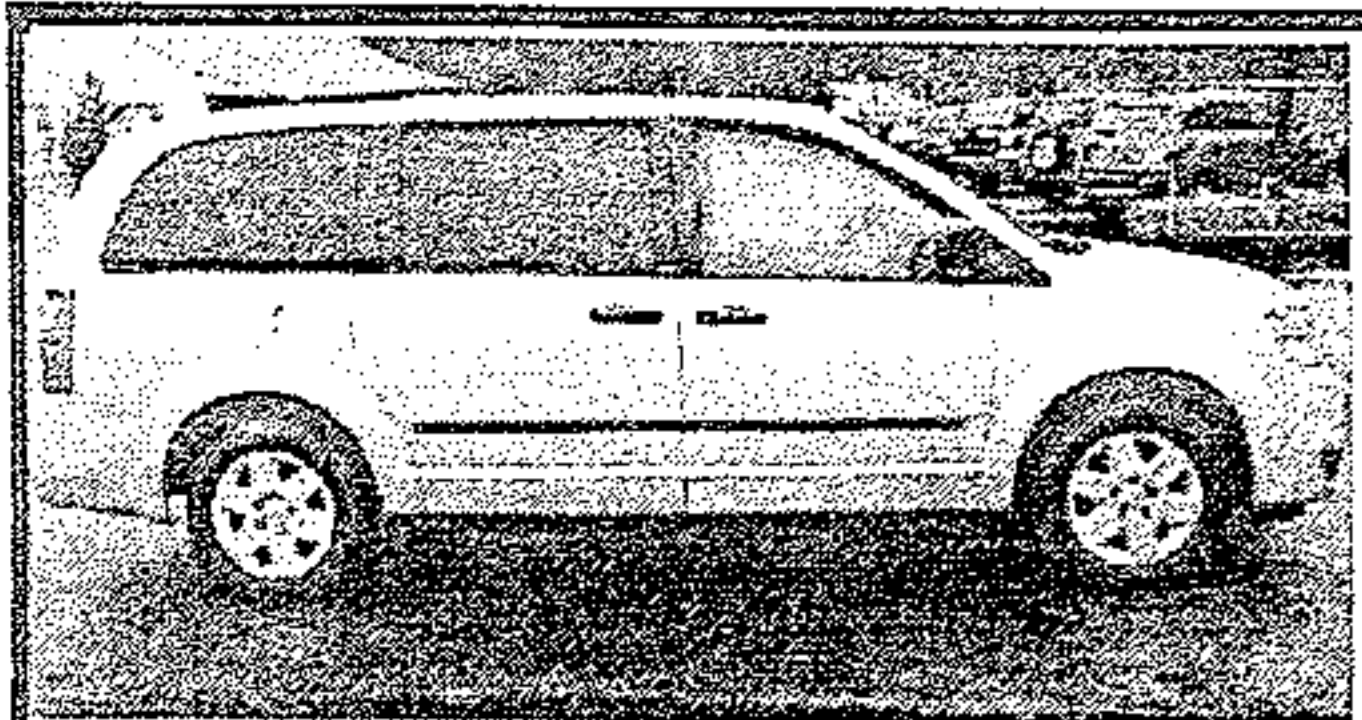

**2008 Dodge Grand Caravan,  
Nice, Clean, Stow n Go!**

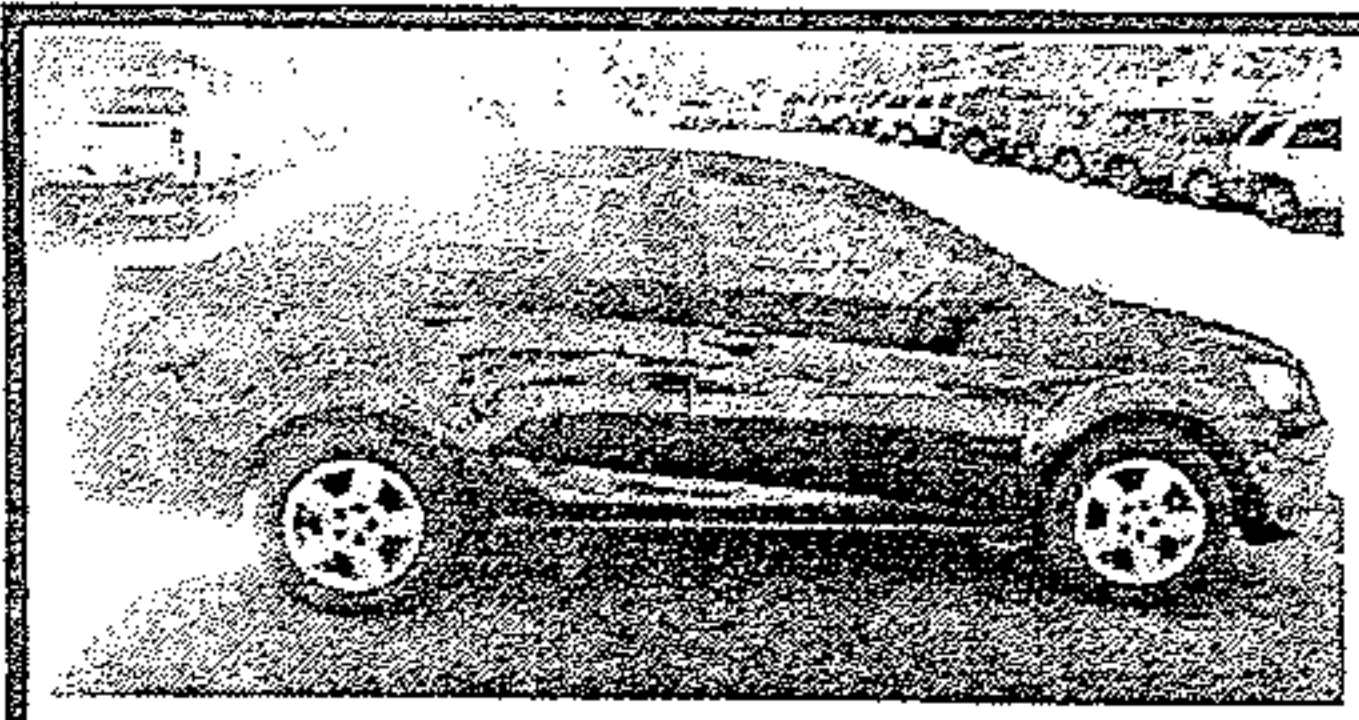

**2014 Chevy Sonic, Factory  
Warranty, Low Miles!**



**Mitsubishi Raider, Ext. Cab,  
Super Nice Truck**

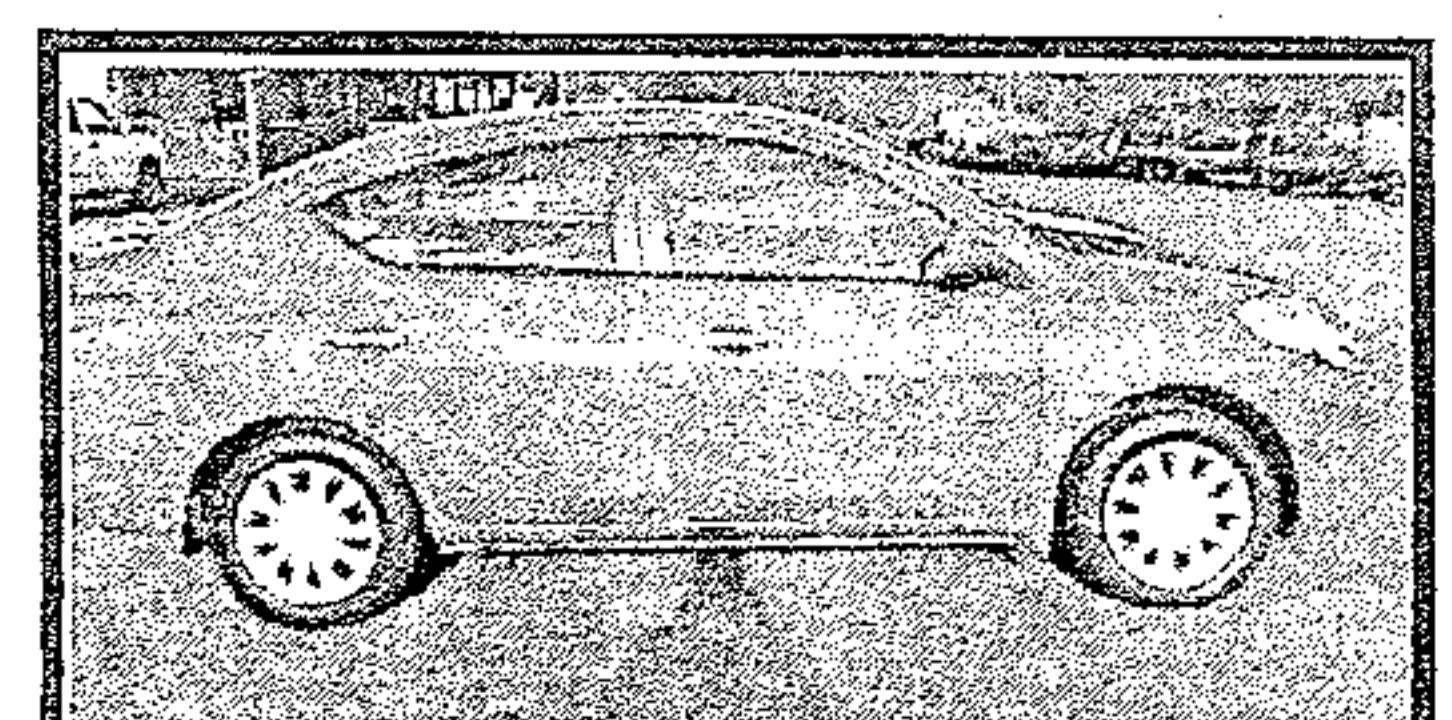

**2013 Nissan Versa, Like New!  
LOADED!!!**

**WALT WILLIAMS, INC.**

\*with approved credit

**3003 Highway 11 Lenoir City, TN 865-986-1111**