

The Daily Edition

50¢

Serving Loudon, Monroe and Surrounding Counties

Wednesday, March 2, 2016

Habitually violent attacker at it again!

(see Habitual pg. 2)

Local Icon and Friend Steve Spoon passes



STEVE SPOON (see Spoon pg. 5)

Charges follow investigation into assault



Maricia Scroggs (see DV pg. 3)

You should have moved over!

Kevin Bryant, 54, at the 71 mm when the North Avenue Rome Ga., was charged with Man/Sell/Del/Resale SCH.VI. Trooper Robert Woody THP, was on a traffic stop on 175

at the 71 mm when the suspect drove by in the right lane where the trooper had to step out to try and get suspect to move over. The Trooper released the

(see THP pg. 7)



Kevin Bryant

Verse of the Day

How great is the love the Father has lavished on us, that we should be called children of God! And that is what we are! The reason the world does not know us is that it did not know him.
— 1 John 3:1

Obituaries

see inside
Wazzup

March Madness is getting ready to be upon us and so is some warmer weather!!!!

Weather

Today: Cloudy early, becoming mostly sunny in the afternoon. High 48F.
Tonight: Clear during the evening followed by cloudy skies overnight. Low 33F.
Thursday Partly cloudy in the morning then becoming cloudy with periods of rain

later in the day. High 51F.
Thursday Night Rain ending early. Remaining cloudy. Low 38F.

Horoscopes

Pisces 2/19-3/20

You are acutely aware of the role you are to play today, but you might not
(Continued on page 6)



habitual

A known habitually violent man has again been charged with another violent crime. This assailant has no care if it is a child, female or law enforcement officer, as he has violently attacked all in the past. This time he broke into a woman's home and when ordered to leave hit the vic-

tim and choked her sending her to the emergency room.

William Allison, 33, Hines Valley Road Lenoir City, was charged with Aggravated Burglary and Aggravated Assault. Deputy Craig Brewer LCSO, was dispatched to Jim Hartsook Drive, and made contact with the victim who stated that William

(see habitual ctd. pg. 4)

Call 865-771-2249 to Advertise and start saving today!
Has your group got an event coming up?
Let us know!!!

To Get a Burning Permit:

Loudon (865) 986-8395
 Monroe (423) 442-7401
 Roane (865) 354-1054

Notice: The Daily Edition does not knowingly accept fraudulent or misleading materials. The Daily Edition cannot guarantee the validity of offerings or statements contained herein. All liability for the contents of all advertising, and for any claims that may arise therefrom, is the responsibility of the advertiser or its agency. The Daily Edition reserves the right to reject, edit, or abbreviate any advertisement submitted. Advertising is accepted with the understanding that all liability for all copyright violations is the sole responsibility of the advertiser. Photographs, artwork and other copy submitted for publication is considered the sole property of the advertiser. The Daily Edition will make every effort but will not be liable for failure to publish and ad or for typographical and layout errors. All statements and information about highlights featured items, letters to the editor, herein are those solely given to the interviewer or writer and the Daily Edition assumes no responsibility of the accuracy or validity thereof. The Daily Edition will gladly reprint at no charge that part of an advertisement in which an error occurs provided a claim is made within 3 days of the first publication of the ad. Information contained in the Wazzup is received anonymously and the Daily Edition assumes no responsibility for information and reserves the right to edit or reject any and/or all submissions. The Daily Edition is a daily newspaper of general circulation in Loudon County defined under TCA 2-1-104(a)(13). The Daily Edition also serves Monroe, Knox, Anderson, Roane and Blount counties and serves 30,000 readers weekly. Send mail to PO Box 1240, Lenoir City TN 37771. 865-771-2249. email: dan1204us@yahoo.com
 The Daily Edition is Loudon County's premier public interest and paid advertising paper. The Daily Edition is produced and published daily Monday through Friday and is circulated throughout Loudon County and parts of Monroe and Knox Counties. Display advertising rates \$5.00 per column inch and quantity discounts available. Call for information on upcoming promotions and events.

HACIENDA Ayala's
Mexican Restaurant
 Market Dr. * Lenoir City (In Front of Food City)

Real Authentic Mexican Food at Affordable Prices

BEST MARGARITA

You've Tried The Rest
 Now Come Have The Best!!!

We Accept ALL Competitors Coupons Outside of Mexico City!
 986-3553

Good Credit OK • Bad Credit OK • Bankruptcies OK • Repo OK



2010 Kia Soul Sporty, 4 cyl, Auto, PW, PL, A/C, Great On Gas, Like New



2010 Ford Escape Limited Leather, Alloy Wheels, Heat, A/C, Luggage Rack, 79K,



2007 Dodge Ram 1500 Quad Cab, Thunder Road PKG, 20 in. Wheels, Low Miles, Hemi



2008 Ford Explorer 84k, 3rd Row Seating, Luggage Rack, Tow Pkg, PW, PL



2011 Ford Ranger Low Miles, Tow Pkg, New Tires, A/C, Heat, Bed Liner.



2011 Dodge Grand Caravan DVD, Stow & Go, Loaded, Remote Doors, Rear A/C

DEPENDABLE MOTORS 986-9343
803 E. Broadway • Lenoir City

* WAC. See Dealer for details

Visit our website at: www.dependablemotorslc.com

Serving Loudon County for 20 Years

DV

Maricia Scroggs, 45, White Wing Road Lenoir City, was charged with Domestic Assault. Deputy JC Schultz LCSO, was dispatched to a domestic on White Wing

Road. Upon arrival Deputy made contact with Maricia Scroggs, who stated she had been in a verbal argument with the victim. The victim had left and went to the Loves Truck Stop. Scrogg had mud on the top of her feet, knees, and her pants were wet in the lower leg area.

Scrogg's stated she was working on a tractor earlier. There was a disturbance area on the ground in front of the residence that appeared to be from a struggle. Deputy Schultz and Palmer responded to Loves Truck Stop and made contact with the victim, who stated that her and Scroggs had been arguing and Scroggs attacked her.

Victim stated she had to put Scrogg on the ground

to to avoid being injured. While Deputies were speaking with victim Scroggs drove by and pulled into the truck stop. Deputy Palmer stopped Scroggs and ask her to exit the

vehicle which she refused. Deputies had to remove Scroggs from the vehicle and placed her under arrest. Deputy JC Schultz LCSO, made the arrest.

For Sale: Oak Wood Mulch

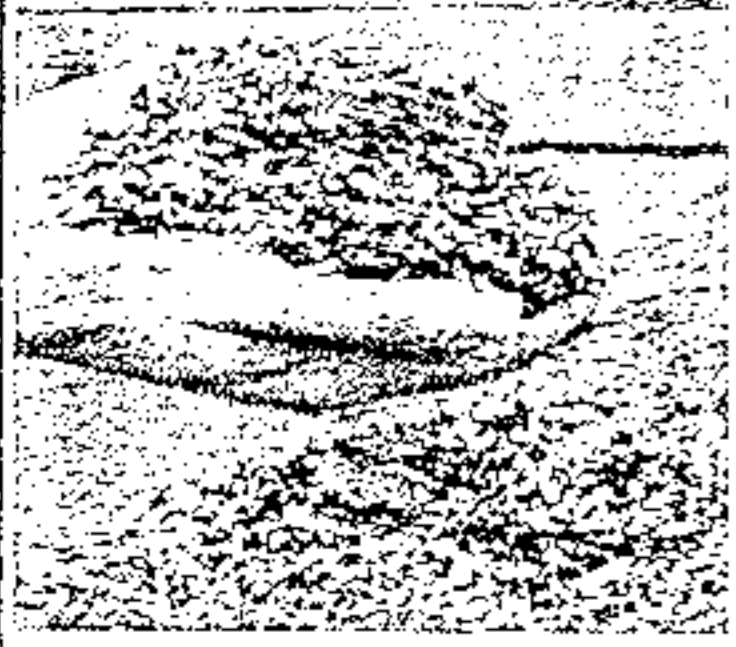

Mushroom Compost Topsoil.



Call Steve Spoon 986-4282

C&C Lawn Care
Mowing, Mulching, Trimming, Edging, Clear Debris
Free Estimates
Call Chad 865-271-8070

West End Storage & Warehouses
502 Ward Avenue • Loudon
Call 865-458-4774 or 865-679-5555

C&J Towing and Recovery
LOWEST TOWING RATES AROUND!!!

Have you been overcharged for any type of towing service in the Lenoir City area? If you have a breakdown or accident please OWNER REQUEST C&J Towing with the officer. Also please call your Sheriff and ask him to place C&J Towing on the "Rotation List*" and help other motorists save as much as you did! We at C&J are locally owned and operated, State approved, licensed, bonded and insured. Call and let us know if your denied service or how we can be of assistance.

*note: the "Rotation List" is a list of wrecker services that provide service for wrecks, DUI's, breakdowns, etc. and are on an on-call basis for service. This list is approved by the Sheriff.

Cliff Teeters • Owner
865-809-1661

STAINED INK
TATTOO & PIERCING
LENOIR CITY 865 816-6440
NEW OWNER • NEW ARTIST • SINCE 2011
521 Hwy 321 next to Vape & Stuff & Inn Of Lenoir!
Clean-Affordable-Quality-Custom
Tattoo's You've Always Wanted!

BRING IN THIS AD FOR **\$25 OFF**
NEW INK FOR NEW CUSTOMERS ONLY!

Check us out on FB.com/
Stained.Ink.Tattoo/
www.STAINEDINC.com

BIMBO'S
Deli Open 24 Hours
865-986-9643 Call Ins Welcome

Specials

Lg. Cold Sub, bag of chips and 16 oz. fountain drink only \$6.29

Footlong Corn Dog \$2.59

habitual ctd. from pg. 2
entered her residence without victim permission. Victim ordered William to leave. William then took victim keys and told her he was taking her vehicle. Victim stood in front of William to try and stop him, William began hitting the victim with his fist. William then put his hands around victim neck and was choking her. Victim eventually broke free from William but suffered a contusion to the right of her face, and red marks on her neck consistent to her being choked. Victim was treated at the ER. Deputy Craig Brewer LCSO, arrested William at the Hines Valley Road address and transported to Loudon Jail.

Help Wanted

**Experienced
Dispatcher
Needed At
Moneymaker
Wrecker Service**
Apply in person
at 11776 Hwy
70, Lenoir City

BUDGET *Transmissions*

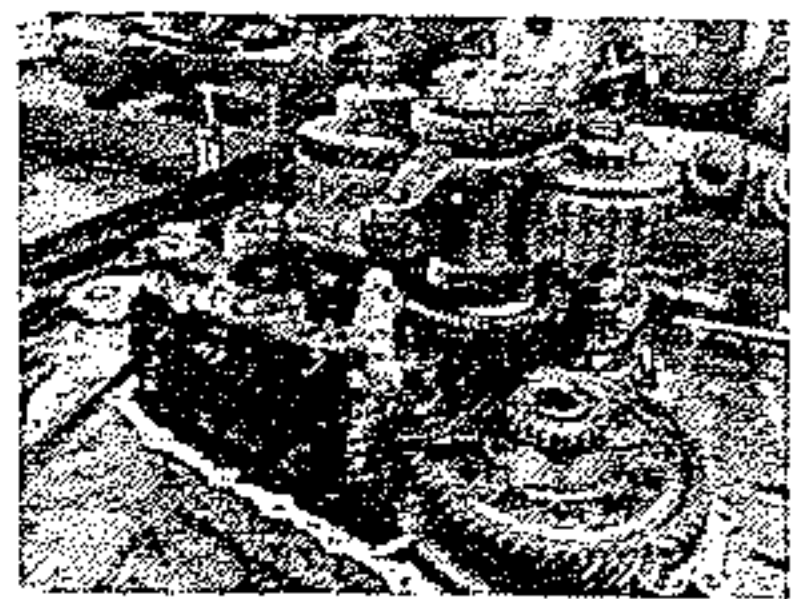

302 S. Northshore Drive Knoxville

(865) 584-4391 budget-transmissions.com

Why Buy From Budget?

Free Towing From Lenoir City
or Loudon County
20 Years of BBB Zero Customer
Complaints Award Member
A+ Plus Rated
Huge Transmission Inventory
Best Technicians Period!!!

Call (865) 584-4391 Today!



Approved
Auto Repair



NEED HELP WITH INCOME TAX? PROFESSIONAL TAX SERVICE

PRICE - 95% of returns between \$60-\$140

(No Coupons Required)

LOCALLY Owned & Operated - Open Year Round

30+ Years in the business

ALL Preparers with 10+ years experience

Pro Tax

111 E. Broadway
Lenoir City, TN 37771
Phone 865-986-4035

**US Armed Service Active Duty Personnel, "THANK YOU", Tax Return Free*

good
to know
you™

IMMEDIATE OPENINGS!

Randstad is NOW HIRING for 2nd shift Assembly Positions at Commercial Vehicle Group. These are long-term, temp-to-hire positions!

Hours: 4:30pm - 3:30am (end times vary)

Pay: \$10/\$10.50 per hour

You may apply by visiting our Facebook page www.facebook.com/vonorejob and clicking the "Sign Up" button. You can also get a paper application from the Guard Shack at 200 National Drive, Vonore, TN 37885.

For questions, call 423.884.4733

www.randstadstaffing.com

EOE



Staffing | Professionals | Search & Placement | HR Solutions | Inhouse Services

Spoon

Weather you have met him or not most everyone has either seen his name or heard it over the last half century in Lenoir City and Loudon County. His name is Steve Spoon and I can guarantee you have seen one his trucks loaded with local firewood or mulch parked all over with a phone number

one the side. Steve has been a personal friend of mine for over 20 years. From the time I we did the TV show on TV38 when he sponsored another friend the late Reed Collins and his church program that aired. Steve pretty much just went ahead and sponsored everything else at that point. If it was a community event, church, program, fund raiser,

or whatever Steve was the kind of guy who said yes with a smile and a kind word. Steve always had kind words he shared with everyone and never met a stranger. Steve will be missed I assure you, and according to family the business will continue.

I don't know where else I would go to get mulch and firewood other than Steve

Spoon. You will be missed my friend and you are suffering no more, be sure and tell Reed we said hey from the Daily Edition and TV38 crew!

Steve Spoon, 59 of Lenoir City, went to be with the Lord Saturday, February 27, at Parkwest Medical Center, surrounded by family and friends. Steve was loving, car-

ing and a hard worker. He started with nothing; financing a little red wagon at Greer's to haul soda bottles at the age of 9. He is preceded in death by his wife, Edna Spoon; stepson, Robert Sartin; mother, Nell Spoon; father, Bill Spoon; sister, Martha Jaynes; and his "second parents" Mae and Fred Skidmore. He leaves behind his sister, Shirley Spoon; brother-in-law, Lewis Franklin; brother-in-law, Wesley Sartin; his niece and loving caregiver, that he loved as a daughter, Carol and Gary Shirk; niece, Frankee Jaynes and Ronald Upton; nephew, Joe and Emily Jaynes; great niece and nephew, Hayden and Holland Jaynes; Aunt, Lennie Taylor; special friends, James and Connie Brandon; and longtime best friend, Gary Bryant; many, many cousins and friends. He will be greatly missed by all who knew him. Funeral service for Mr. Spoon will be 7 p.m. Wednesday, Loudon Funeral Home Chapel, with Pastor Alex Townsend officiating. Graveside service 1 p.m. Thursday, at Steekee Cemetery. Family will receive friends Wednesday, 5 to 7 p.m. at Loudon Funeral Home. www.loudon-funeralhome.net

Place Your Ad In The Daily Edition. Call 865-771-2249

PURDY'S AUTO PARTS AND SALVAGE
WE BUY SCRAP IRON • COPPER • BRASS • ALUMINUM

\$ **Paying Top \$\$\$**
 Call For Latest Prices

You Name It, We Buy It!

Radiators, Wheels, Batteries, Appliances, Farm Equipment

Copper
 Paying Top \$\$\$
 Call For Latest Prices

Complete Cars
 per 100 lbs.

Scrap Metal
 Paying Top \$\$\$
 Call For Latest Prices
 per 100 lb

We Buy Batteries

Aluminum Cans
 Paying Top \$\$\$
 Call For Latest Prices

**Now Selling
 Aftermarket
 Body Parts at
 Discount Prices**

You Call We Haul!
423-519-5402

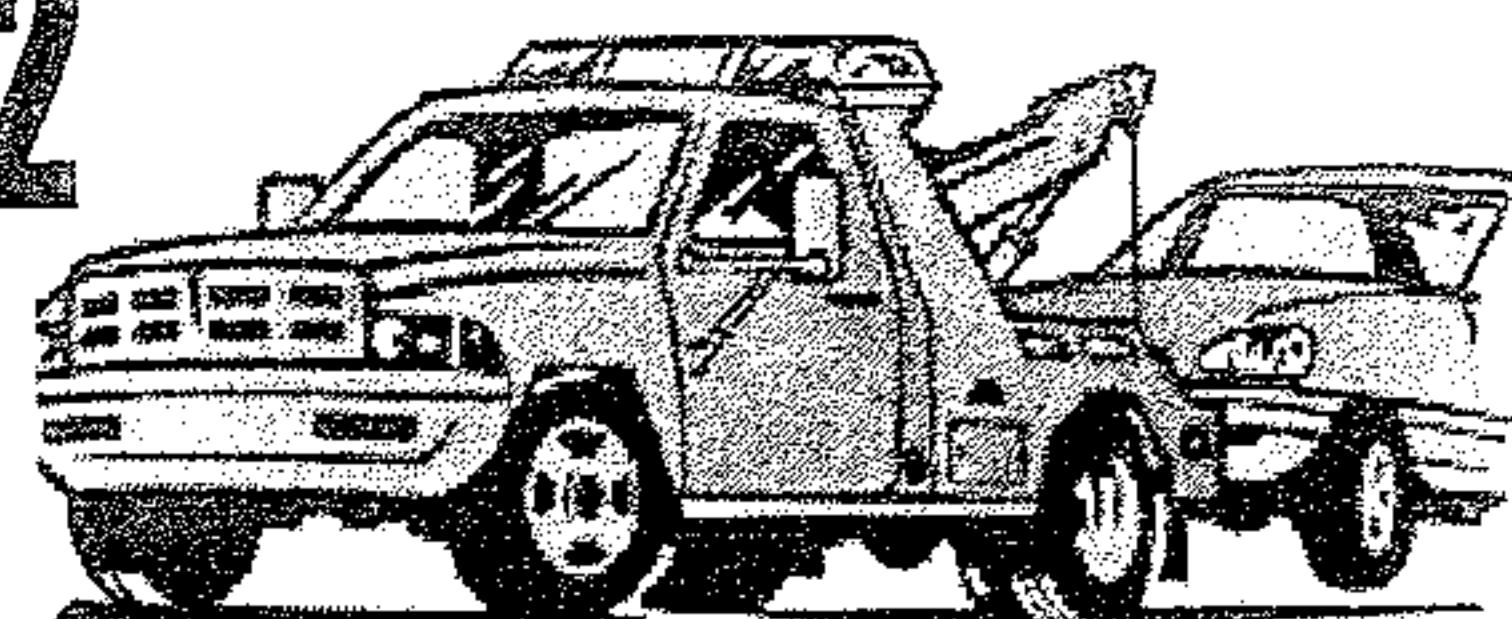

* Prices subject to change with the market.

423 337-3977
149 County Road 323 Sweetwater

* Prices subject to change with the market.

THP

stop he was on and stopped the suspect for the move over law. Upon contact with the driver identified as Kevin Bryant, Trooper could smell the odor of marijuana coming from the vehicle. Trooper had Kevin exit the vehicle and Kevin told Trooper there was some marijuana in the vehicle about an 1/2 ounce. A search of the vehicle Trooper found an 15 grams of marijuana in Kevin bag and an additional 2 ounces in his coat. Kevin was placed under arrest. Trooper Robert Woody THP, made the arrest.

One of two individuals charged in serial armed bank extortion scheme pleads guilty in federal court

On Mar. 1, 2016, Brian Scott Witham, 45, of Waterville, Maine, pleaded guilty to charges contained in a December 2015, 15-count indictment involving armed bank extortions of the Y-12 Federal Credit Union in Oak Ridge, Tenn., SmartBank in Knoxville, Tenn., and Northeast Community Credit Union in Elizabethton, Tenn.

Additionally, as a part of his plea agreement, Witham agreed to plead guilty to similar charges from three other federal jurisdictions including the Western District of North Carolina, the Middle District of Pennsylvania and the District of Connecticut

which he, the U.S. Attorneys and the federal judge all consented to transfer to U.S. District Court in the Eastern District of Tennessee. These charges include: being a firearm in possession of a firearm in Haywood County, N.C.; armed robbery of an Ingles in Arden, N.C.; armed robbery of the Peoples Security Bank and Trust in Clarks Summit, Pa.; and attempted armed bank extortion of the Achieve Financial Credit Union in New Britain, Conn.

Sentencing for Witham is set for Aug. 17, 2016, in U.S. District Court in Knoxville.

The plea agreement, which is on file with U.S. District Court in Knoxville, contains detailed information regarding the crimes Witham admits to committing along with co-defendant Michael Anthony Benanti, 43, of Lake Harmony, Pa. Benanti is also charged in this case and is currently in custody awaiting trial currently scheduled for March 29, 2016.

Numerous law enforcement agencies were involved in this investigation. Tennessee agencies included: FBI Knoxville Resident Agency, along with the FBI Safe Streets Task Force; Knoxville Police Department; Knox County Sheriff's Department; Johnson City Police Department; Carter County Police Department; Oak Ridge Police Department; and Elizabethton Police Department. North Carolina agencies included: FBI Asheville Resi-

dent Agency; North Carolina State Highway Patrol; North Carolina State Bureau of Investigation; Asheville Police Department; Maggie Valley Police Department; Waynesville Police Department; Haywood County Sheriff's Office; and, Buncombe County Sheriff's Office. Pennsylvania agencies included the FBI Harrisburg Resident Agency assisted by state and local law enforcement. Connecticut agencies

Help Wanted

Position Available Immediately! Apply in person at the Kenjo Marathon on Hwy 321 in Lenoir City.

LONNIE JONES OPTICAL DISPENSARY
 "We Make The Difference You Can See"
 Locally Owned and Operated

Over 1000 Frames To Choose From
 No Frame Over \$69.00 

On the corner of A & Depot Street, Lenoir City
986-7803
 Serving Loudon County for over 40 years

LOOK! \$75 Weekly Payments LOOK!

MARTY'S AUTO SALES • 986-2222 • MARTY'S AUTO SALES • 986-2222 • MARTY'S AUTO SALES • 986-2222 • MARTY'S AUTO SALES • 986-2222 • MARTY'S AUTO SALES • 986-2222

Bad Credit
 Divorce
 Fixed Income
 Repos
 Bankruptcy
 No Credit

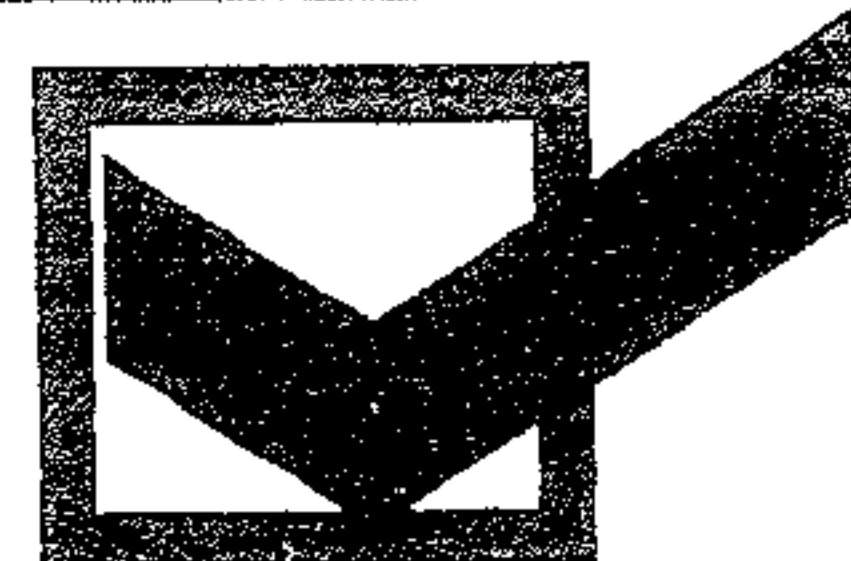

APPROVED!

Visit Us On The Web At:
martysautosales.net

NO CREDIT CHECKS

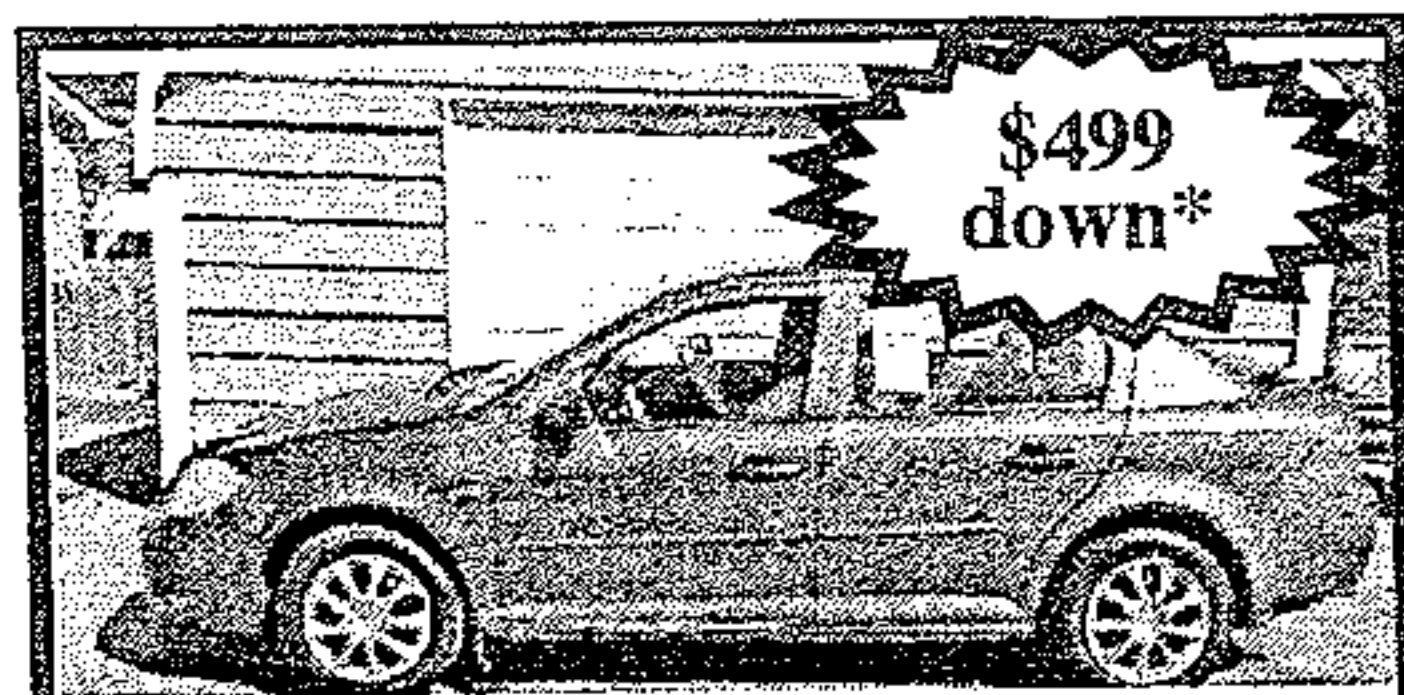

07 Cobalt, 5spd, gas saver, runs great Only \$499 down*

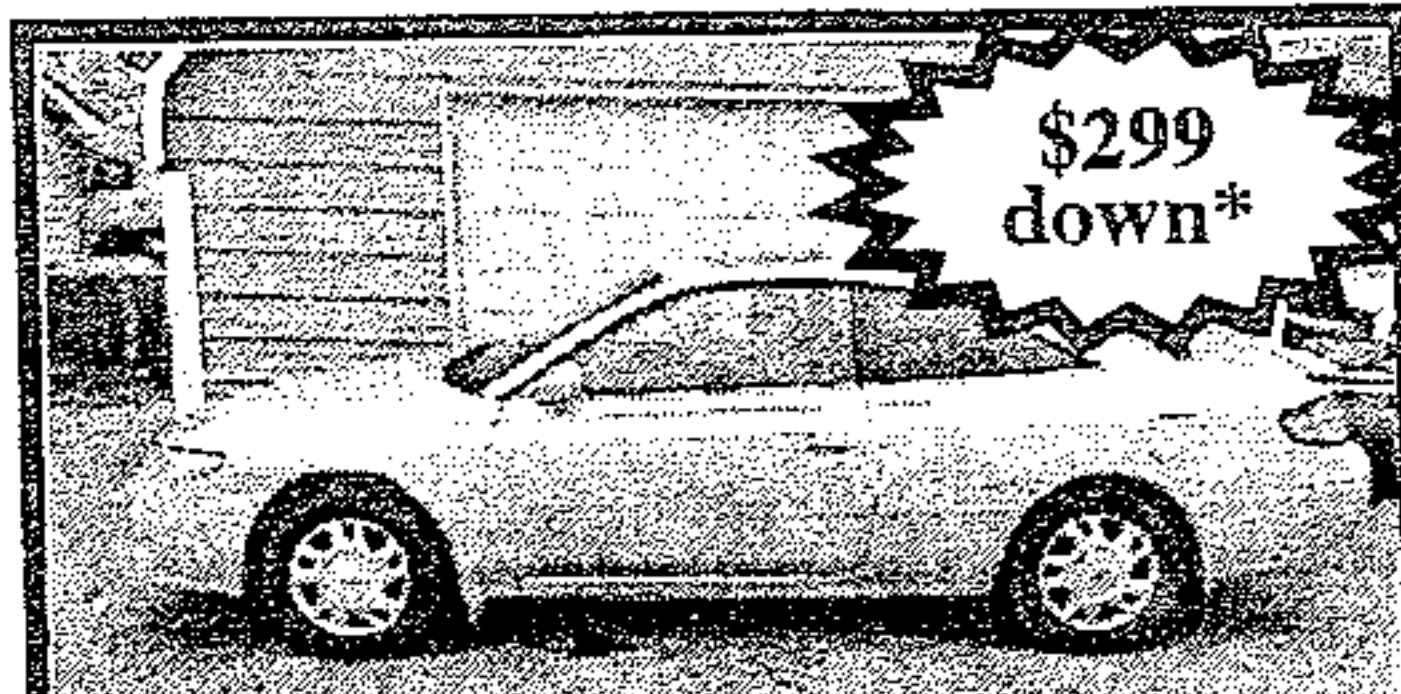

99 Solara, V6, auto, sporty, Only \$299 down*

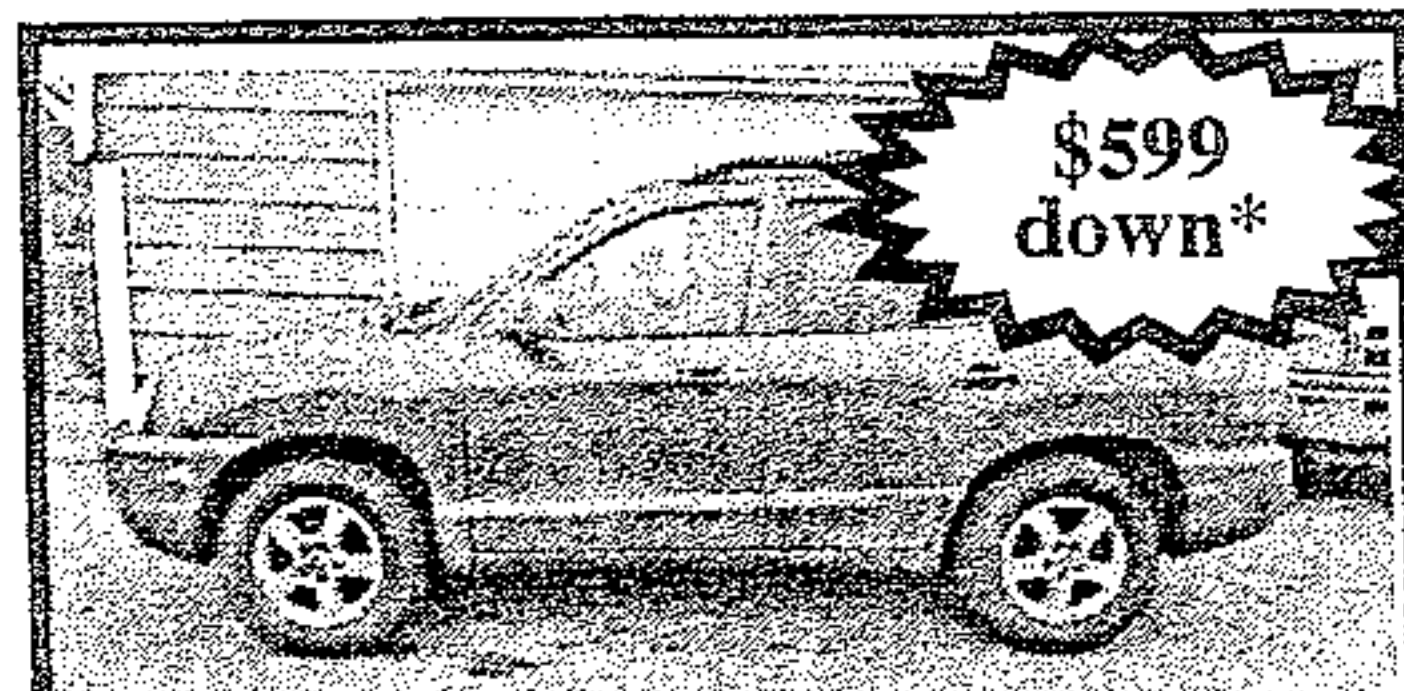

04 Santa Fe, auto, Nice, clean, Only \$599 down*

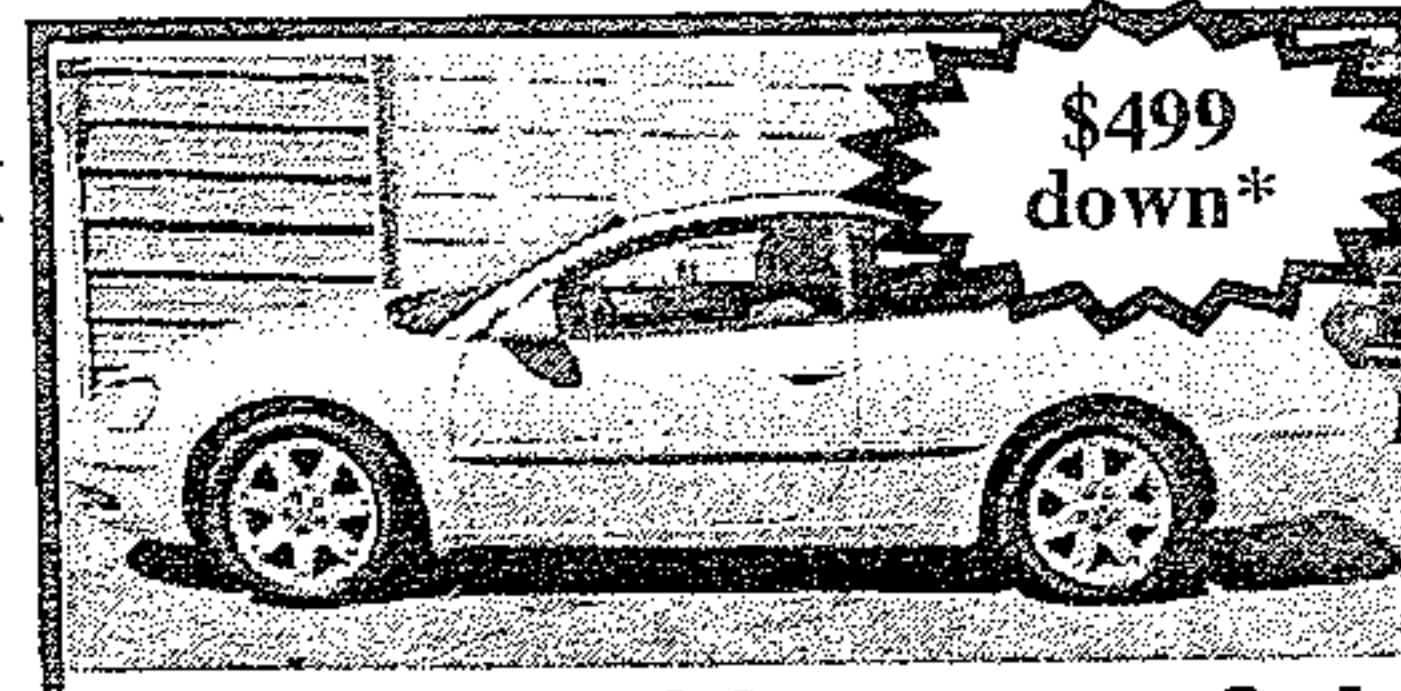

01 Sebring 2dr. sporty, Only \$499 down*

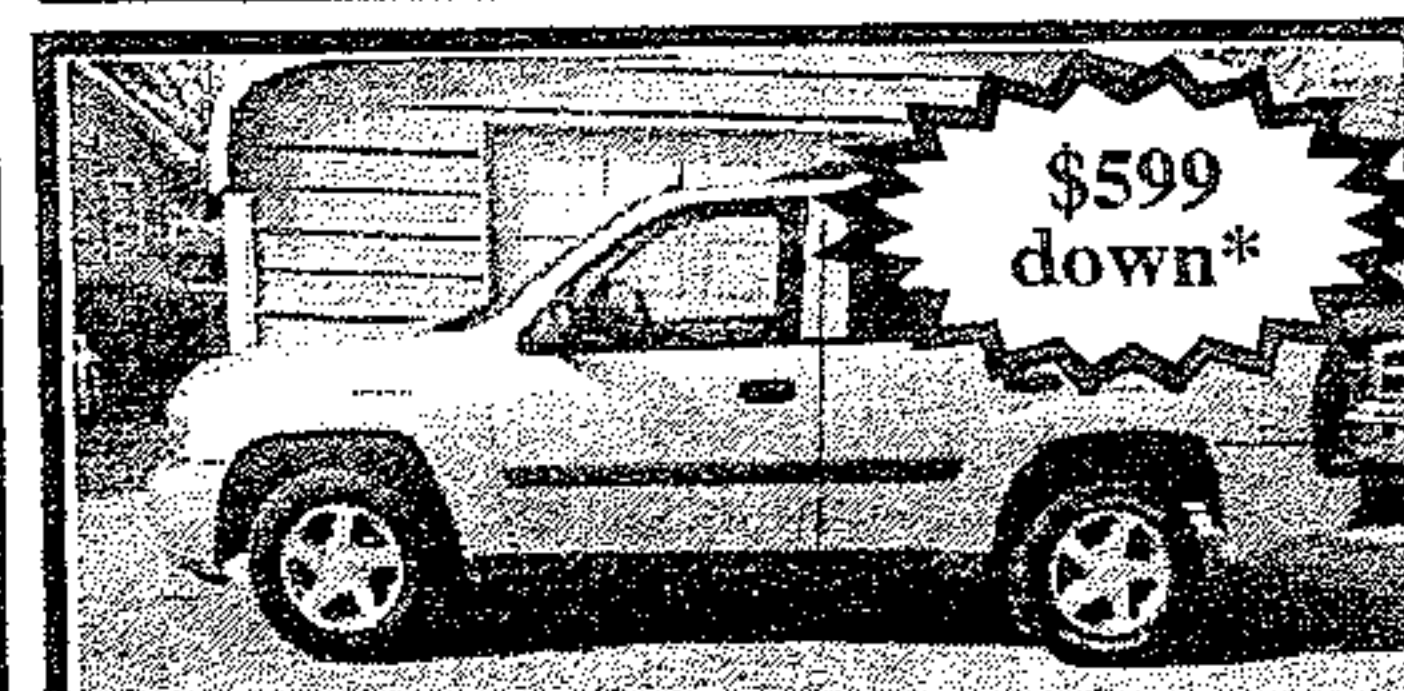

05 Trailblazer, auto, good miles Only \$599 down*



04 Aveo, auto, gas saver, Only \$499 down*

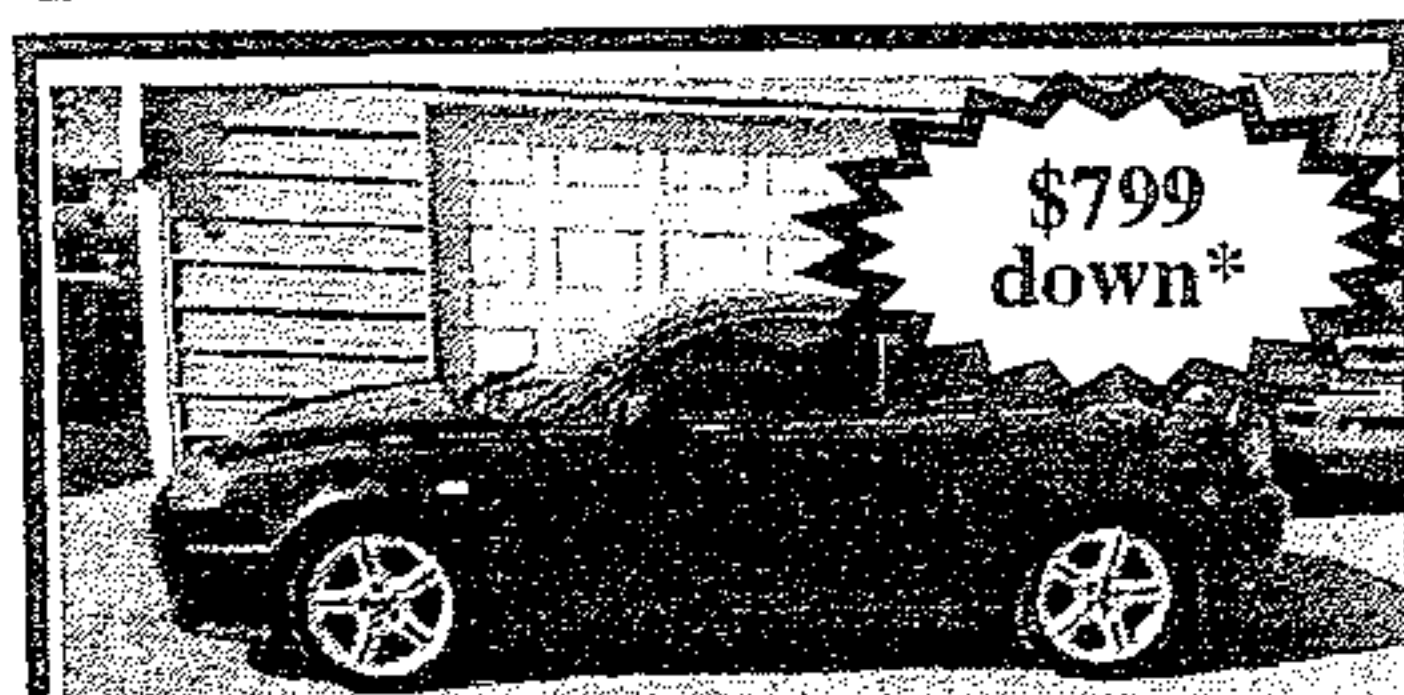

06 Tiburon GT, 5 speed, sporty, Only \$799 down*

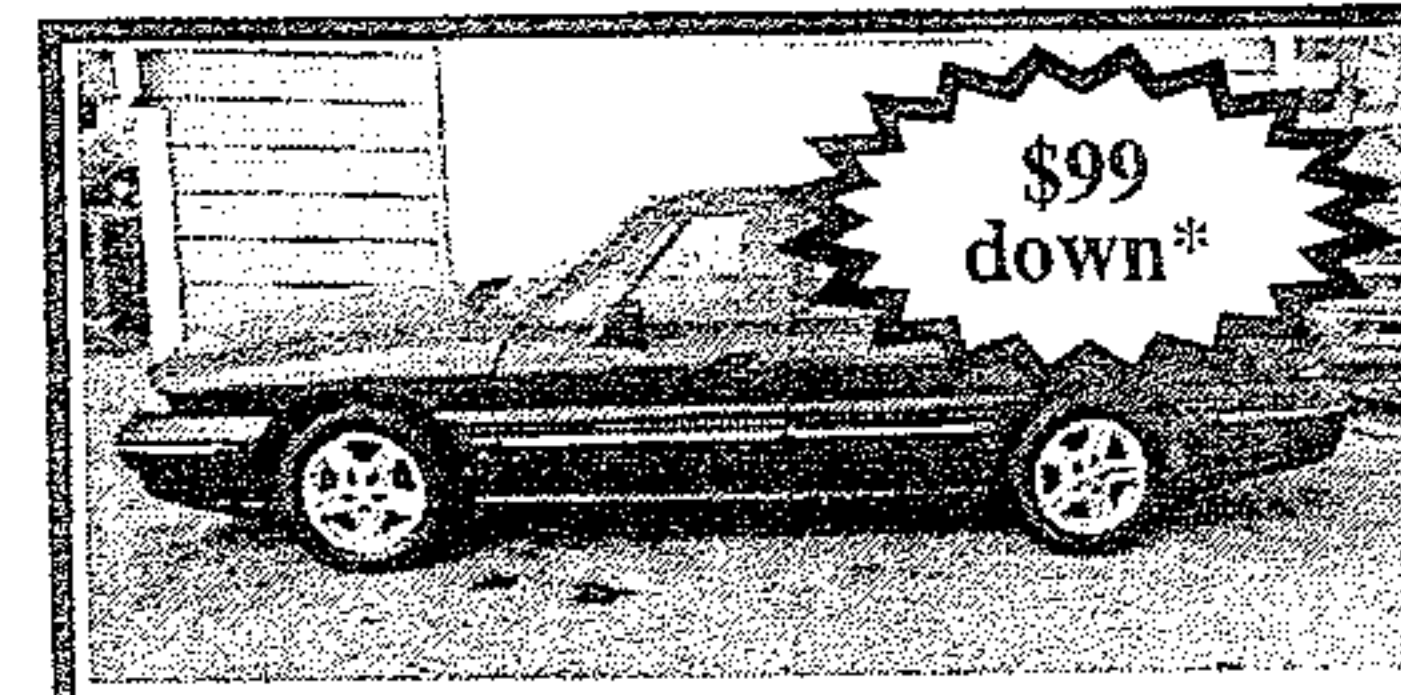

98 Bonneville, 6 cyl, Auto, low payments only \$99 down*

NO Credit Checks

Marty's Auto Sales
986-2222 Se Habla Español

100% Approval*

*See Dealer for details. All down payments plus tax, tag, title and fees.

MARTY'S AUTO SALES • 986-2222 • MARTY'S AUTO SALES • 986-2222 • MARTY'S AUTO SALES • 986-2222 • MARTY'S AUTO SALES • 986-2222 • MARTY'S AUTO SALES • 986-2222

guilty conc. from pg. 7

included: FBI New Haven Resident Agency; Bristol Police Department; New Britain Police Department; Connecticut State Police; Farmington Police Department; and Berlin Police Department.

The following Assistant U.S. Attorneys were assigned to represent the United States in their various districts: Jacabed Rodriguez-

Coss, District of Connecticut; Assistant U.S. Attorney John Gurganus, Middle District of Pennsylvania; and Assistant U.S. Attorney Don Gast; Western District of North Carolina. Assistant U.S. Attorneys David P. Lewen, Jr. and Steven H. Cook from the Eastern District of Tennessee represent the United States in this combined guilty plea.

THE RELIC SHOP

521 Hwy 321 Lenoir City Suite 3
next to Stained Inc and the Inn of Lenoir
865-250-9280

WE ARE IN TUCSON, ARIZONA BUYING UP FOSSILS FOR THE SHOP. WE NEED TO MAKE ROOM!!!

ALL AMETHYST 40% OFF

GREAT SELECTION OF ANCIENT MEGALADON SHARK TOOTH OVER 8 MILLION YEARS OLD

Is Your Washer Broken?

Call Me

I Only Charge \$100 Period!!!

Call Allen

865-617-7113

A Name You Already Know And Trust Just Got Even More Dependable
DEPENDABLE AUTO SERVICE, LUBE AND TIRES
is Now Offering
Expert, Affordable Transmission Service

All ASE Certified Technicians

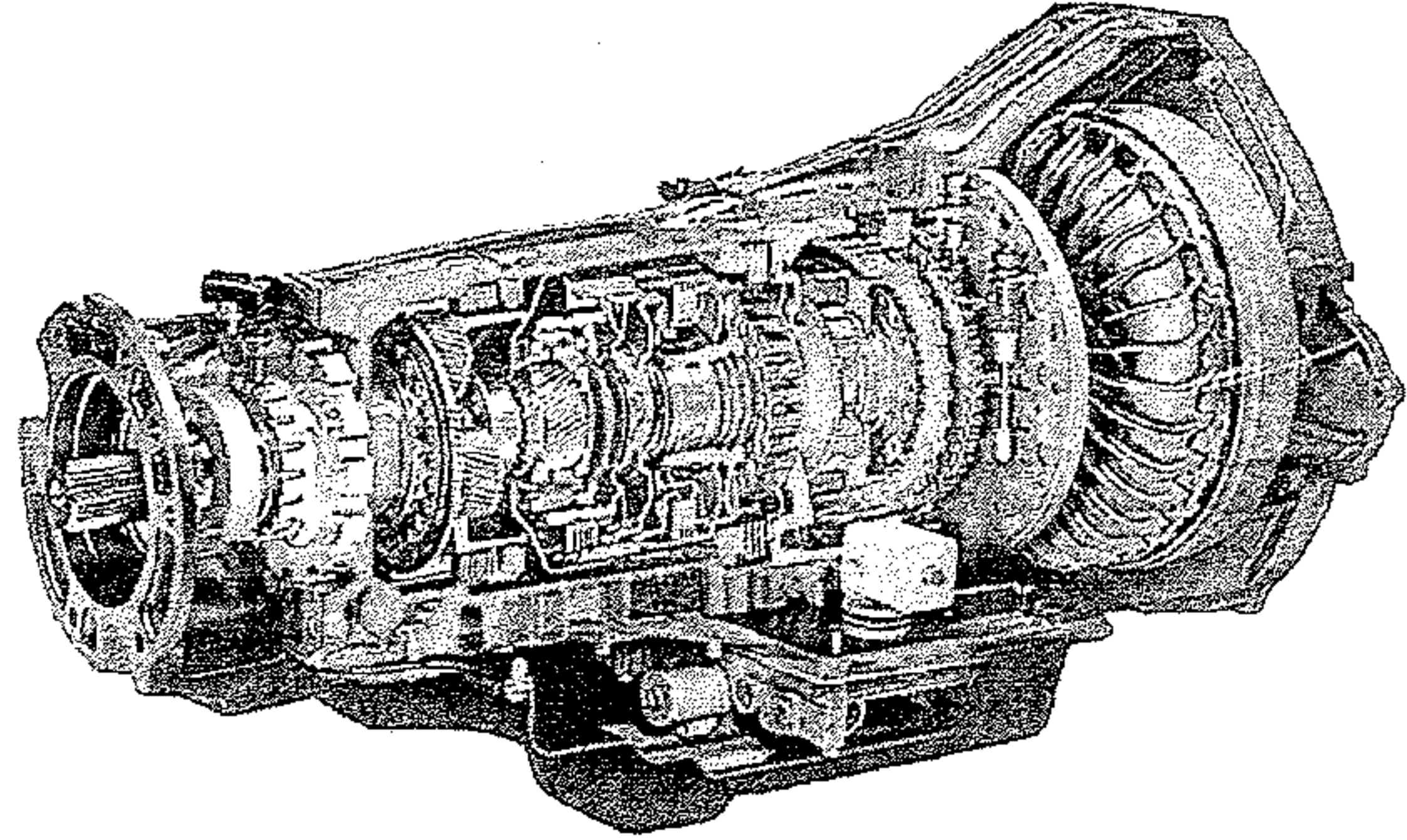

We proudly welcome all New Customers and Former Advanced Transmission Customers with a 10% Discount and Any Transmission Service or Repair*

865-986-9359

865-986-5050

Bad Credit, No Credit OK!!! We Finance Everybody!!!

Taxes Done Here!!! Bring your last pay stub or W2 and DRIVE TODAY!!!

Over 100 Cars, Trucks & Vans in Stock - Warranties On ALL Vehicles Sold!!!

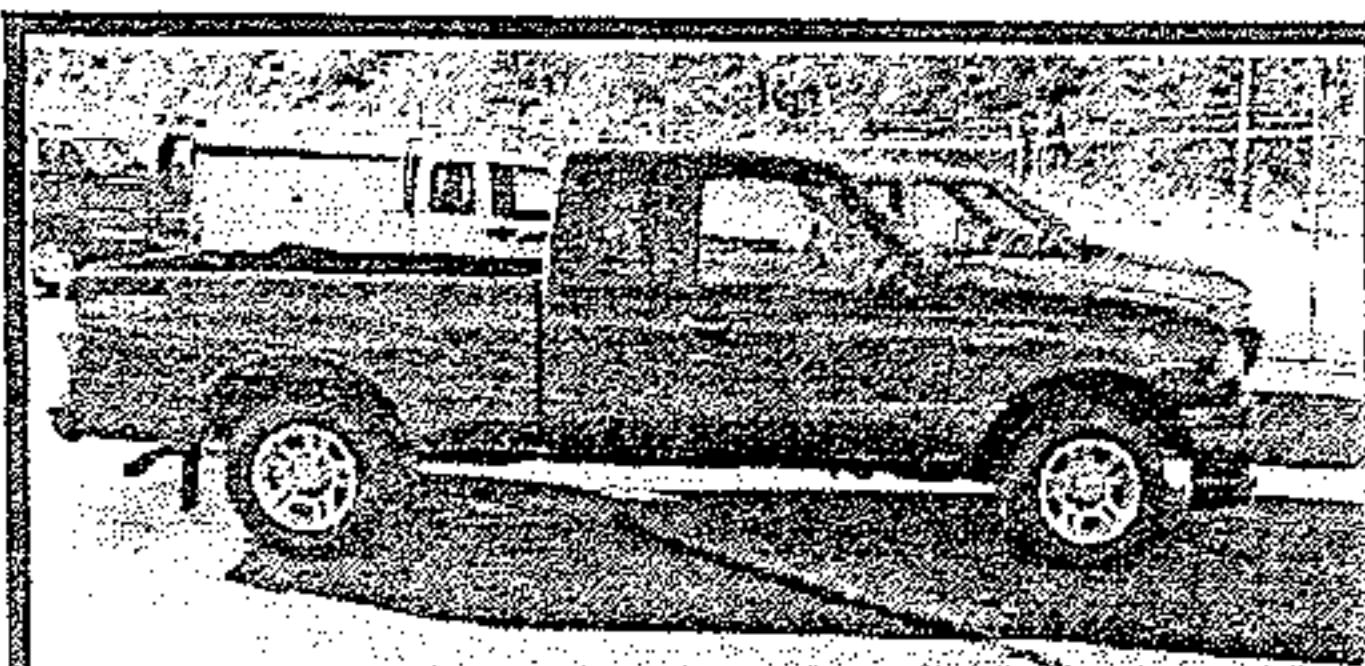

2005 Ford Ranger, Super Nice Truck, Very Low Miles

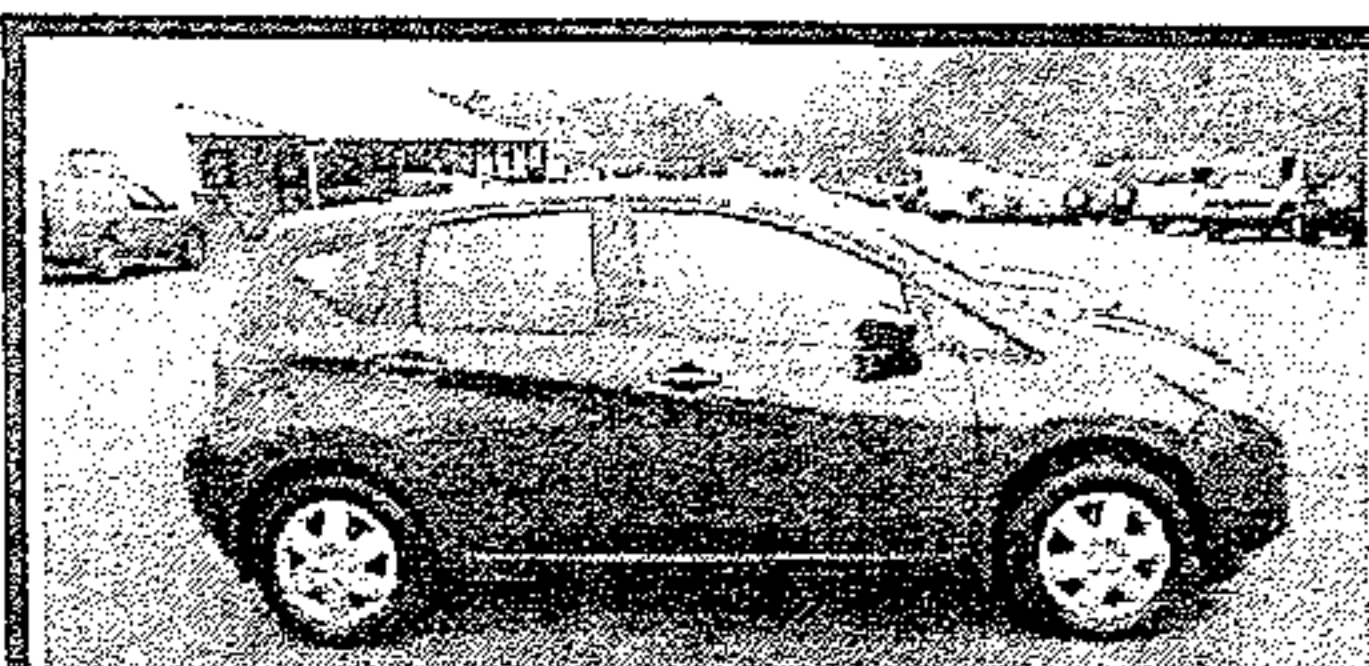

2015 Nissan Versa Note, Factory Warranty, Low Miles

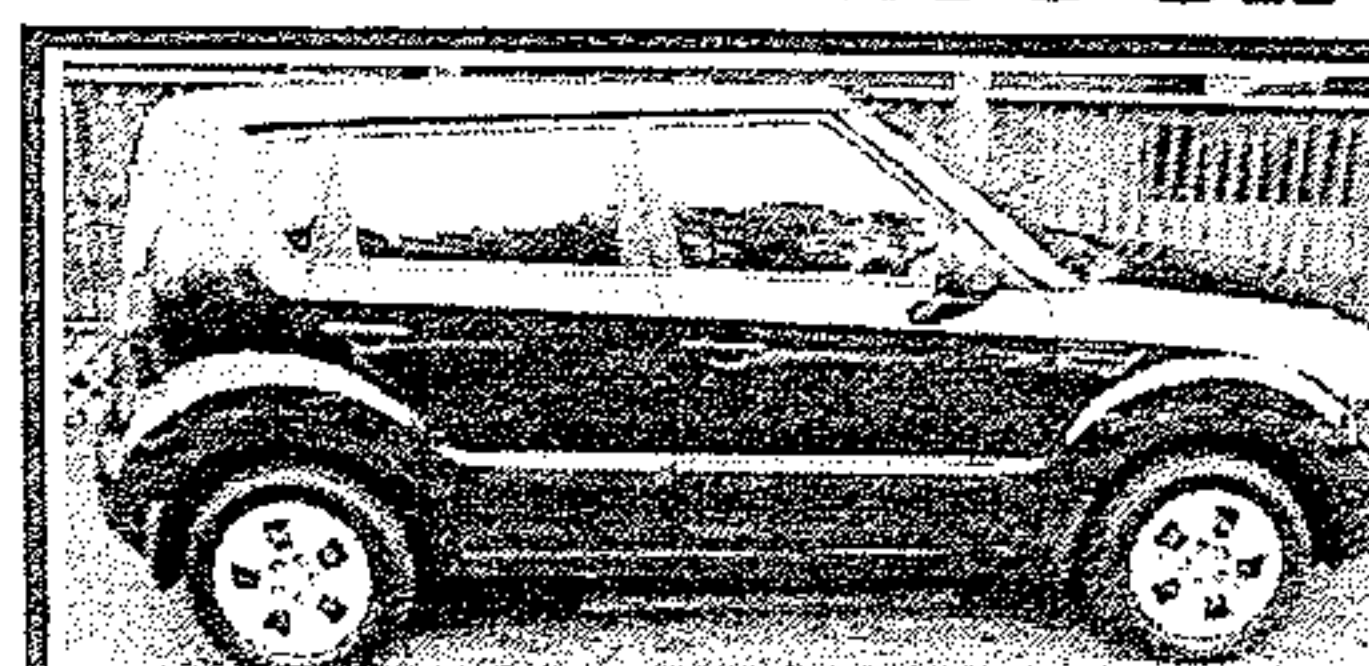

2011 Kia Soul, 5 speed, 4 dr, Gas Saver, Nice & Clean



2008 Saturn VUE, LOADED!!! 4dr, Ready to go on a trip!

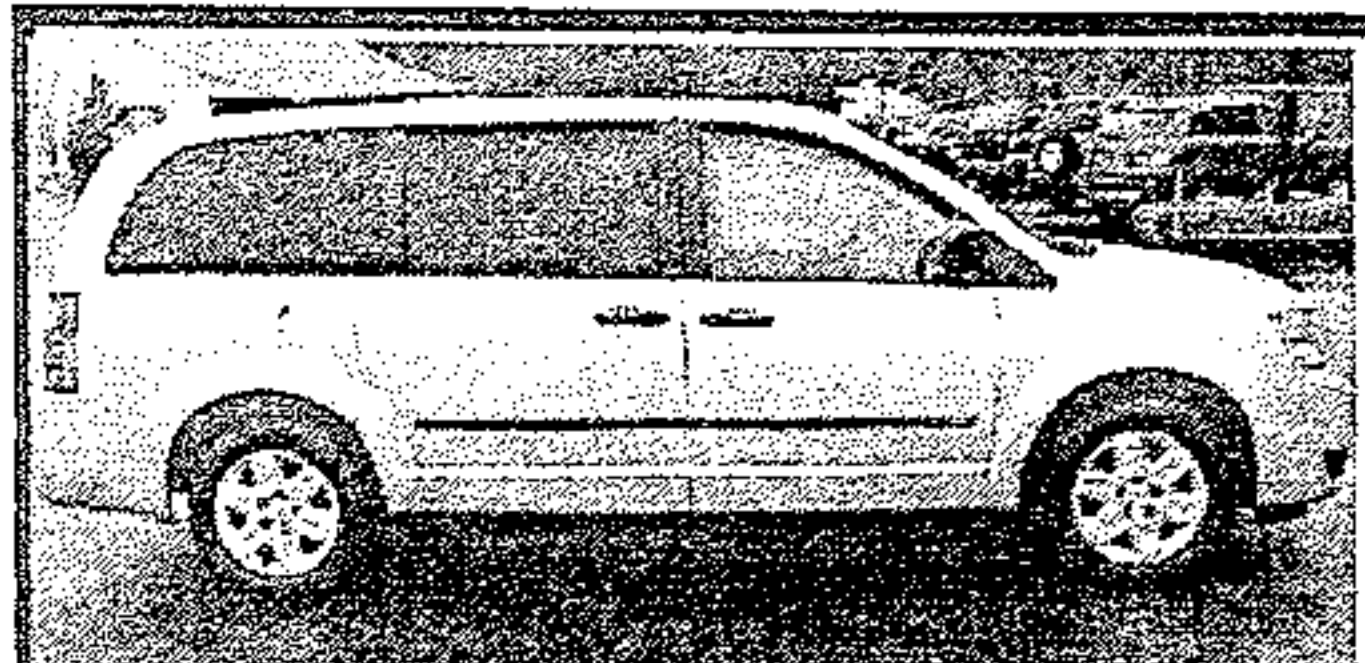

2008 Dodge Grand Caravan, Nice, Clean, Stow n Go!

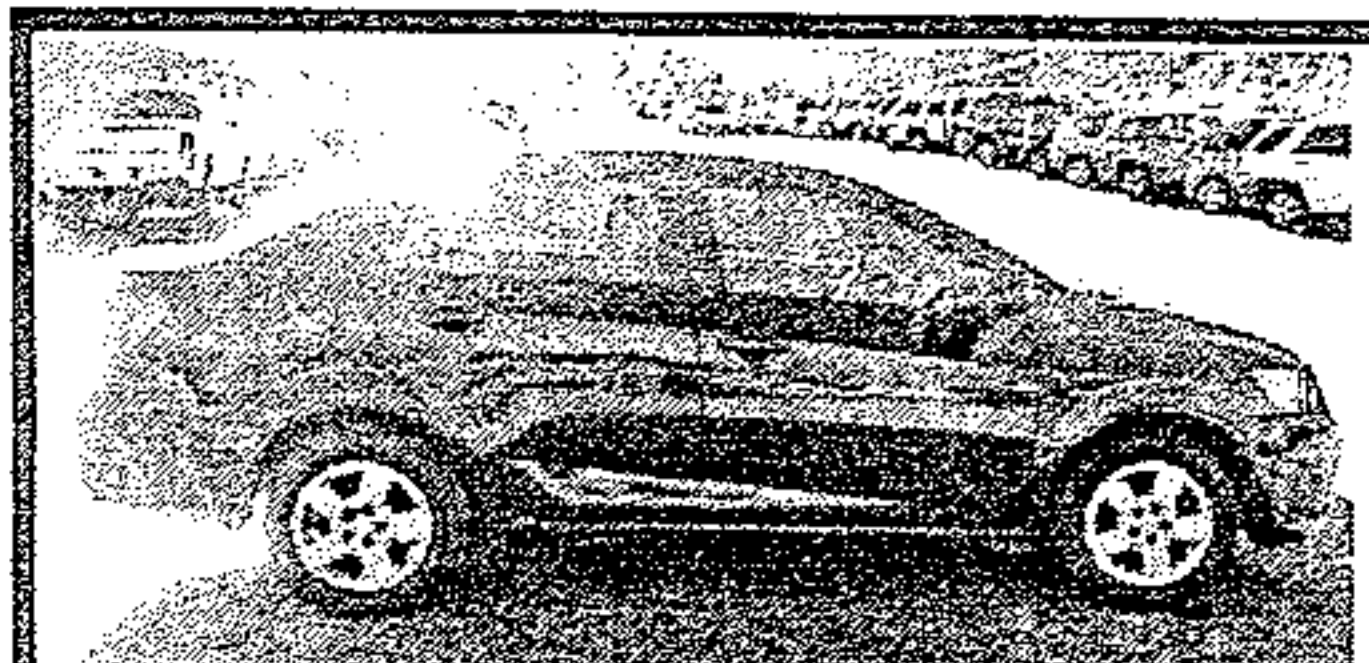

2014 Chevy Sonic, Factory Warranty, Low Miles!



Mitsubishi Raider, Ext. Cab, Super Nice Truck

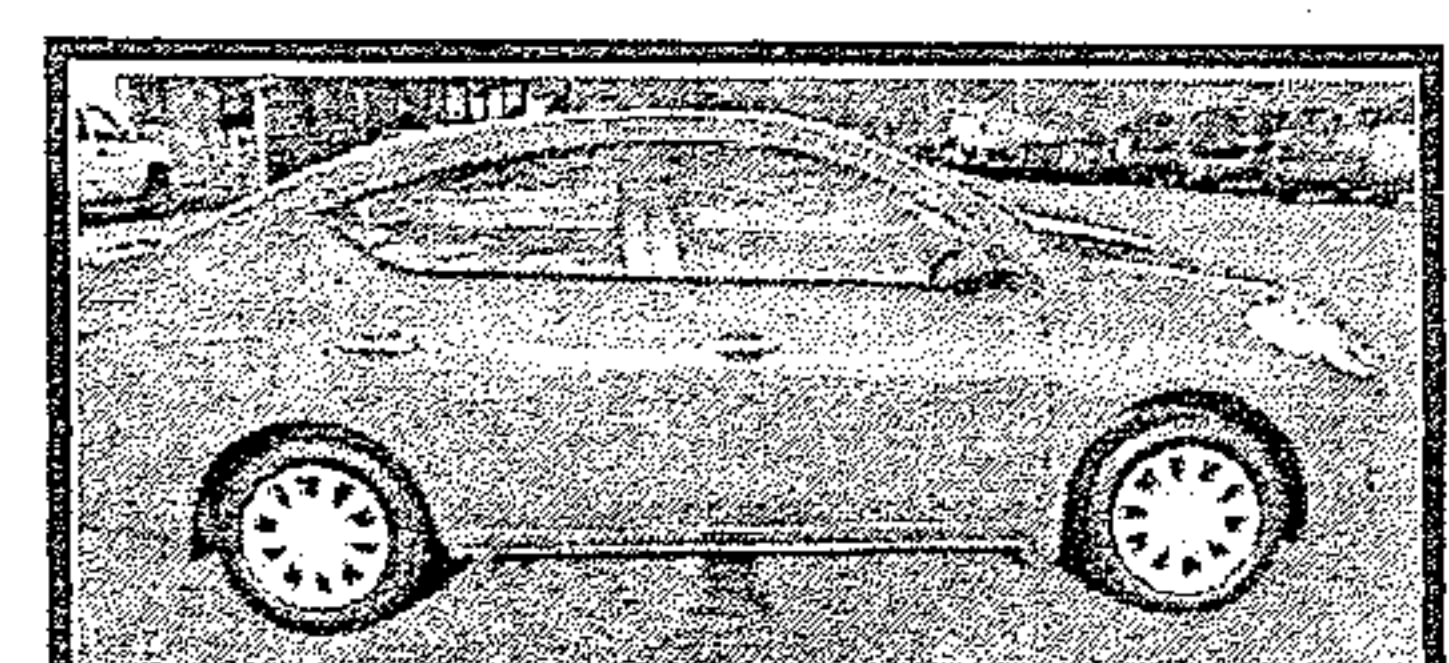

2013 Nissan Versa, Like New! LOADED!!!

WALT WILLIAMS, INC.

*with approved credit

3003 Highway 11 Lenoir City, TN 865-986-1111