

The Daily Edition

50¢

Serving Loudon, Monroe and Surrounding Counties

Wednesday, March 16, 2016

Lots of questions remain in shootout at Bimbo's

There was an officer involved shooting in Lenoir City early Sunday morning (approximately 1:02 am EST) at the Bimbo's convenient store/restaurant/gas on Hwy 321 near the I-75 interchange involving a Lenoir City Police Officer and one deceased subject who was apparently shot by the officer multiple times. After being notified of the shooting by Lenoir City Police Chief Don White, the

9th District Attorney General Russell predicated the investigation of the incident to the Tennessee Bureau of Investigation. The TBI responded immediately with a team of field agents and later with their Violent Crimes Response Team of forensic specialists to work the extend scene. The investigation of the scene continued until well after noon on Sunday.

The deceased sub-

ject is Joshua William Grubb W/M, dob 8-12-1985 of 321 Kentucky Avenue, Clinton, Tennessee. The next of kin has been notified by TBI.

The officer is Tyrel Lorenz W/M, dob 10-13-86 who has been with the Lenoir City Police Department since July of 2015 of and a law enforcement officer since 2010.

The incident resulted from a call into 911 from the Ruby Tues-

(see shootout pg. 2)

Suspicious vehicle stop ends with drug bust



Selena Gribble

(see bust pg. 5)

Pills, needles and more! Oh My!

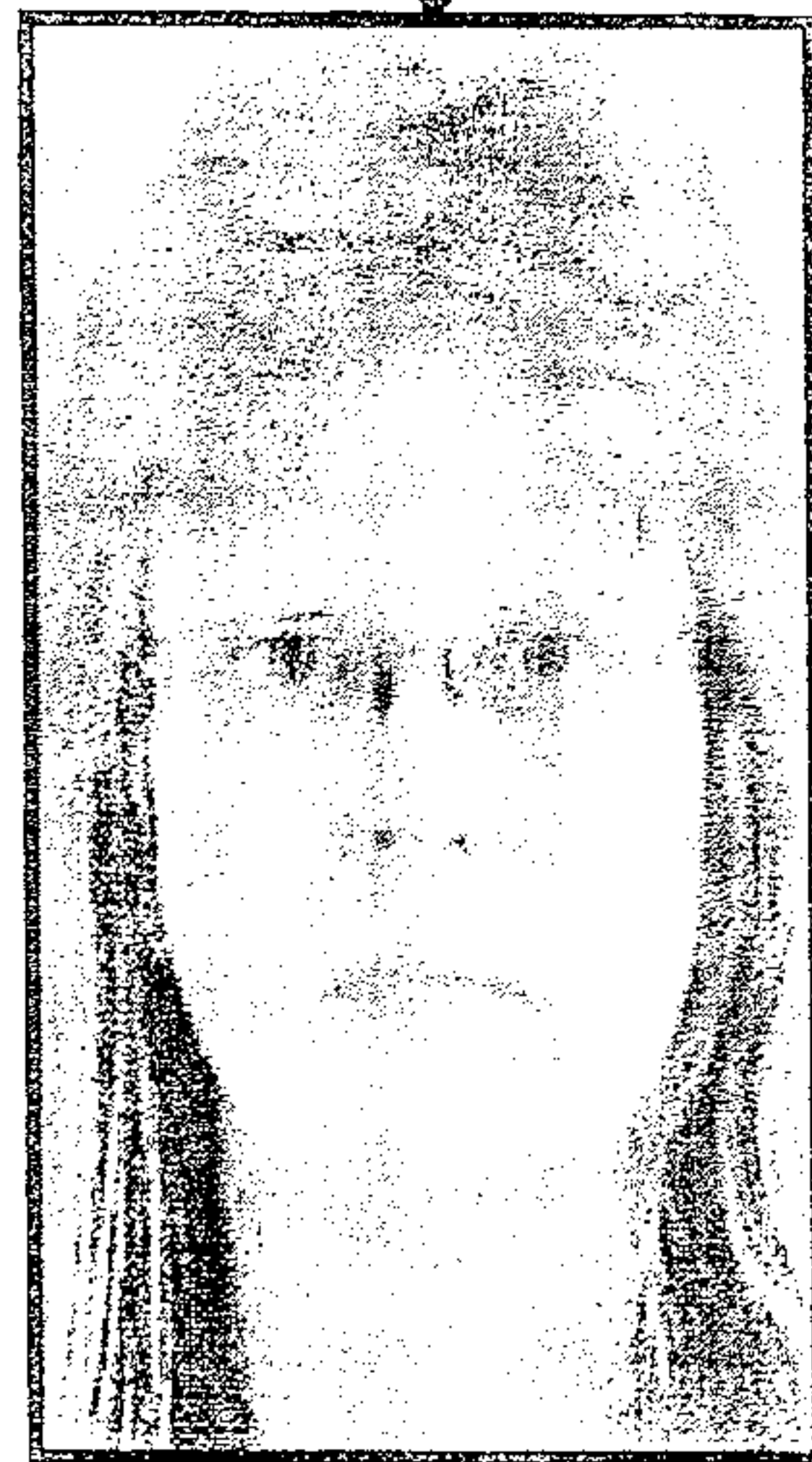

Carla Grimstead

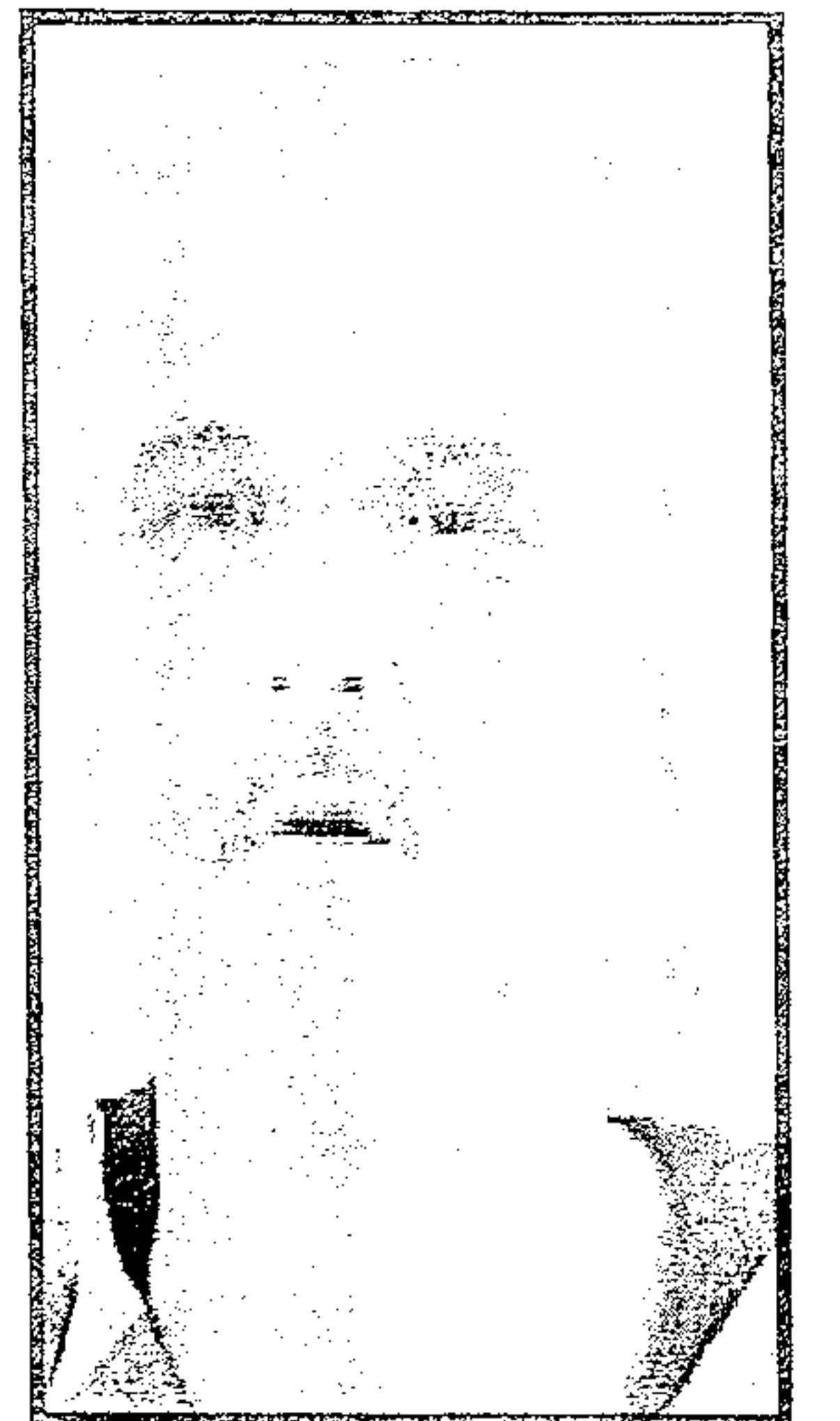

William Lanter

(see charged pg. 3)

Former Receptionist Stole Money from Tennessee State Veterans' Home

Former receptionist Marilyn Truss has been charged with theft after a Comptroller's investigation revealed that she stole at least \$7,906 from the Tennessee State Veterans' Home in Murfreesboro, Tennessee. The investigation was conducted in conjunction with the Tennessee Bureau of Investigation.

(see Veterans pg. 7)

Home Federal Bank Robbery

On Friday, 03/11/2016, law enforcement agencies responded to a bank robbery at the Home Federal Bank of Tennessee, 2940 South Mall Knoxville, Tennessee.

At approximately 9:25 a.m., the Home Federal Bank of Tennessee was robbed by a heavy set white male who drove a black or dark

(see robbery pg. 5)

Verse of the Day

"And I will put enmity between you and the woman, and between your offspring and hers; he will crush your head, and you will strike his heel."

— Genesis 3:15

Obituaries

see inside Wazzup

The See Something, Say Something philosophy is not necessarily the best idea every

time. Not everyone is committing a crime.

Weather

Today: Sunshine and some clouds. High 69F. Tonight: A few clouds from time to time. Low 43F.

Friday Plentiful sun-

shine. High 66F. Friday Night A few clouds. Low 38F. Horoscopes Pisces 2/19-3/20 Unfortunately, once you start explaining your perspective to a friend or as

(Continued on page 6)



shootout

day's restaurant/bar located directly across Hwy 321 from the Bimbo's location regarding three individuals who had just left the Ruby Tuesday's parking lot in a pickup truck. Officer Lorenz was apparently questioning the three individuals in the truck who were getting gas at Bimbo's and

in fact, had placed one male individual in handcuffs when the driver began trying to drive off. Lorenz commanded the driver to stop several times before Lorenz somehow ended up in the back bed of the pickup truck. Once in the truck bed Lorenz was still yelling at the driver to stop. It was after Lorenz was in the

(see shootout ctd. pg. 4)

Call 865-771-2249 to Advertise and start saving today! Has your group got an event coming up? Let us know!!!

To Get a Burning Permit:

Loudon (865) 986-8395
 Monroe (423) 442-7401
 Roane (865) 354-1054

Notice: The Daily Edition does not knowingly accept fraudulent or misleading materials. The Daily Edition cannot guarantee the validity of offerings or statements contained herein. All liability for the contents of all advertising, and for any claims that may arise therefrom, is the responsibility of the advertiser or its agency. The Daily Edition reserves the right to reject, edit, or abbreviate any advertisement submitted. Advertising is accepted with the understanding that all liability for all copyright violations is the sole responsibility of the advertiser.

Photographs, artwork and other copy submitted for publication is considered the sole property of the advertiser. The Daily Edition will make every effort but will not be liable for failure to publish and ad or for typographical and layout errors. All statements and information about highlights featured items, letters to the editor, herein are those solely given to the interviewer or writer and the Daily Edition assumes no responsibility of the accuracy or validity thereof. The Daily Edition will gladly reprint at no charge that part of an advertisement in which an error occurs provided a claim is made within 3 days of the first publication of the ad. Information contained in the Wazzup is received anonymously and the Daily Edition assumes no responsibility for information and reserves the right to edit or reject any and/or all submissions. The Daily Edition is a daily newspaper of general circulation in Loudon County defined under TCA 2-1-104(a)(13).

The Daily Edition also serves Monroe, Knox, Anderson, Roane and Blount counties and serves 30,000 readers weekly. Send mail to PO Box 1240, Lenoir City TN 37771. 865-771-2249. email: dan1204us@yahoo.com

The Daily Edition is Loudon County's premier public interest and paid advertising paper. The Daily Edition is produced and published daily Monday through Friday and is circulated throughout Loudon County and parts of Monroe and Knox Counties. Display advertising rates \$5.00 per column inch and quantity discounts available. Call for information on upcoming promotions and events.

HACIENDA Ayala's
 Mexican Restaurant
 Market Dr. * Lenoir City (In Front of Food City)

Real Authentic Mexican Food at Affordable Prices

BEST MARGARITA

You've Tried The Rest Now Come Have The Best!!!

We Accept ALL Competitors Coupons Outside of Mexico City!

986-3553

Good Credit OK • Bad Credit OK • Bankruptcies OK • Repo OK



2010 Kia Soul Sporty, 4 cyl, Auto, PW, PL, A/C, Great On Gas, Like New

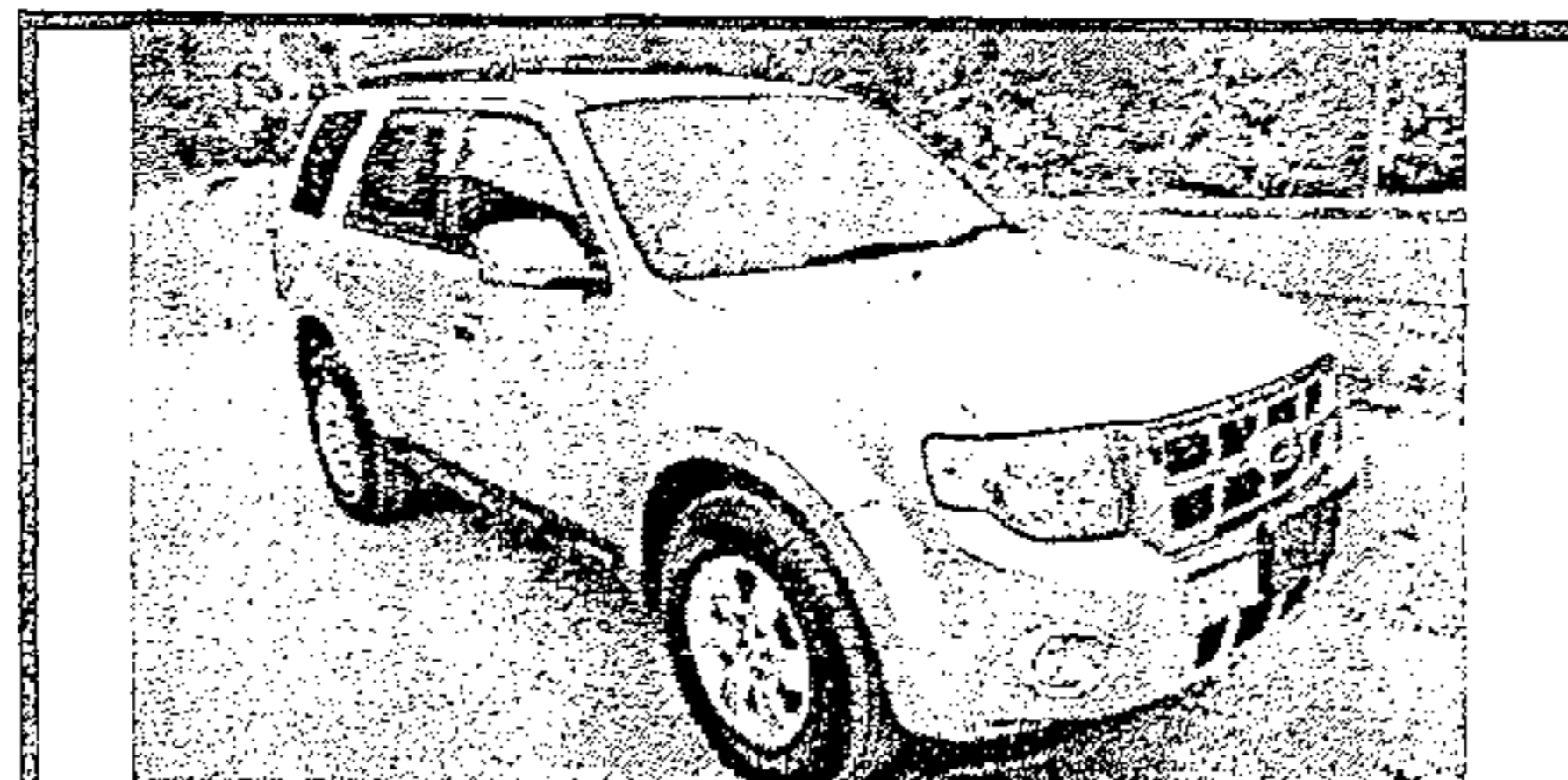

2010 Ford Escape Limited Leather, Alloy Wheels, Heat, A/C, Luggage Rack, 79K,

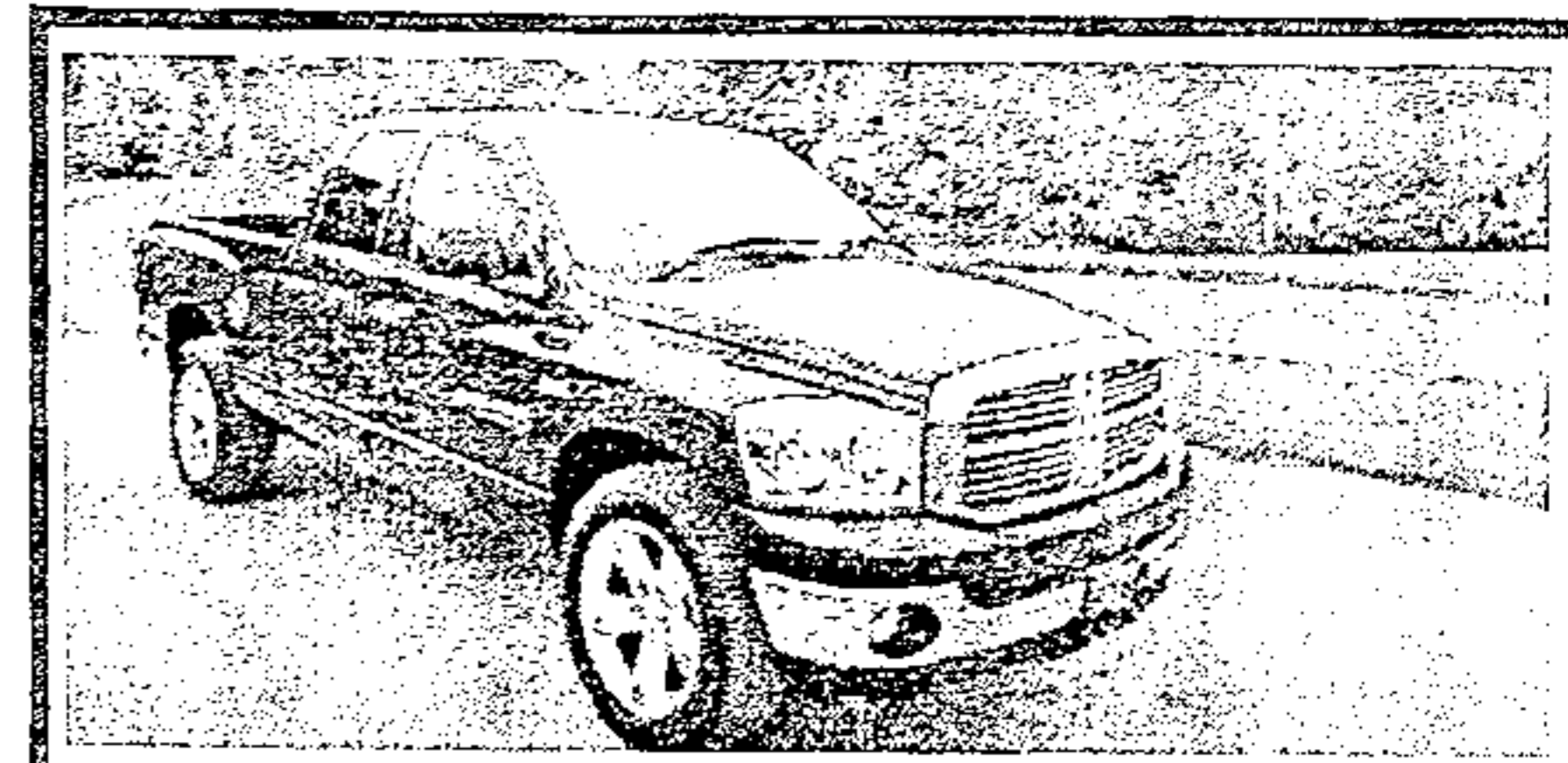

2007 Dodge Ram 1500 Quad Cab, Thunder Road PKG, 20 in. Wheels, Low Miles, Hemi

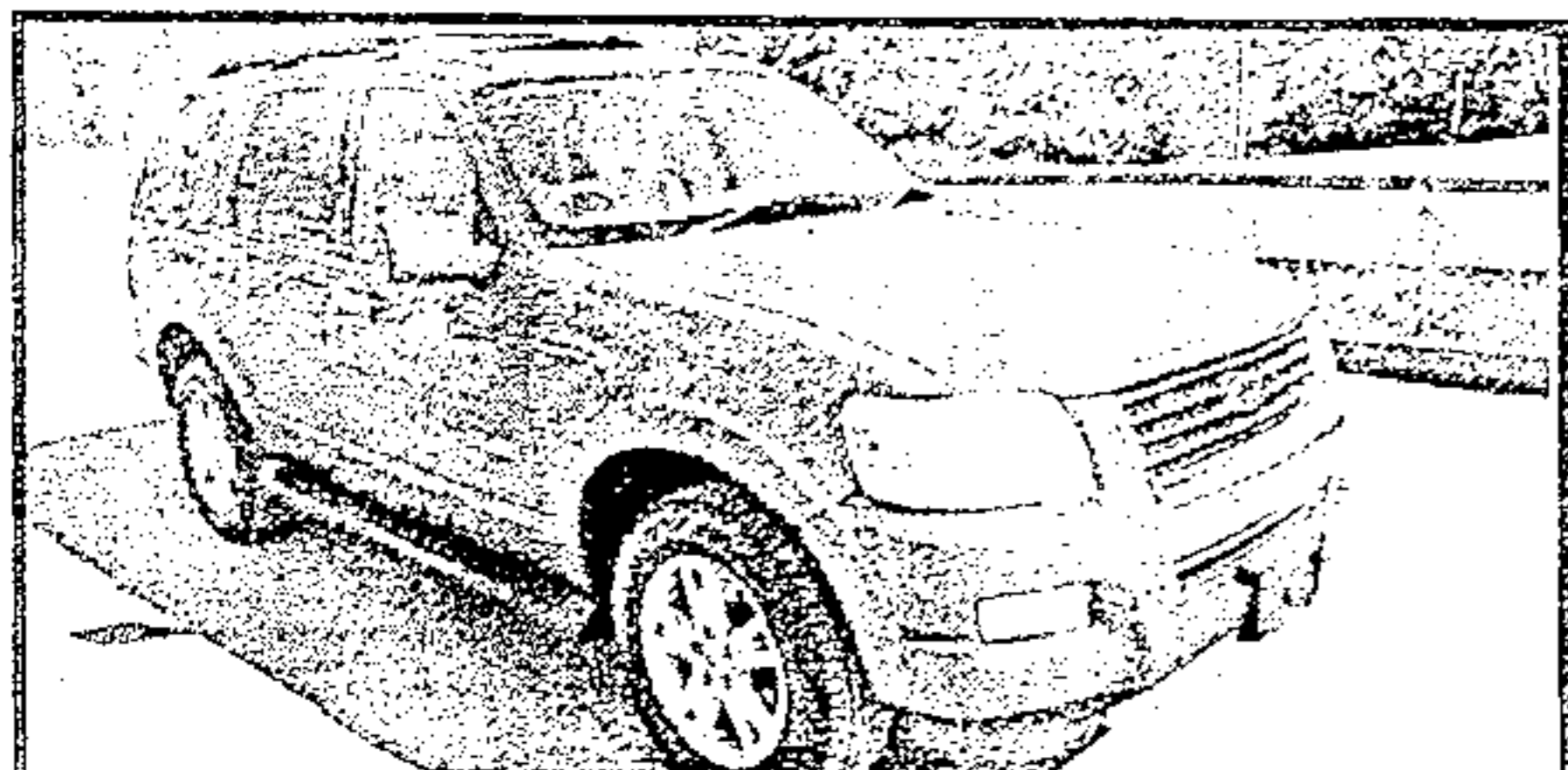

2008 Ford Explorer 84k, 3rd Row Seating, Luggage Rack, Tow Pkg, PW, PL

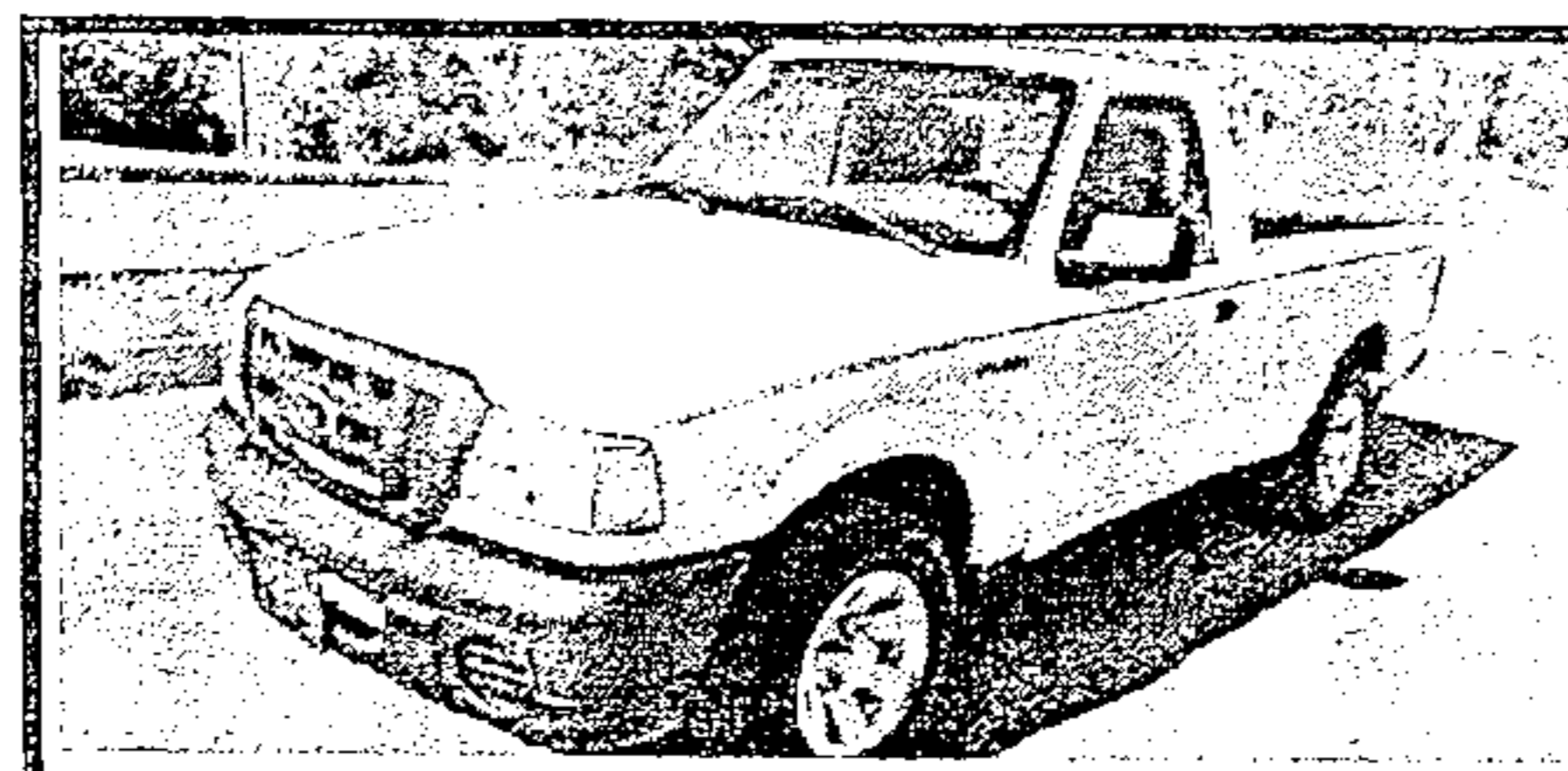

2011 Ford Ranger Low Miles, Tow Pkg, New Tires, A/C, Heat, Bed Liner.

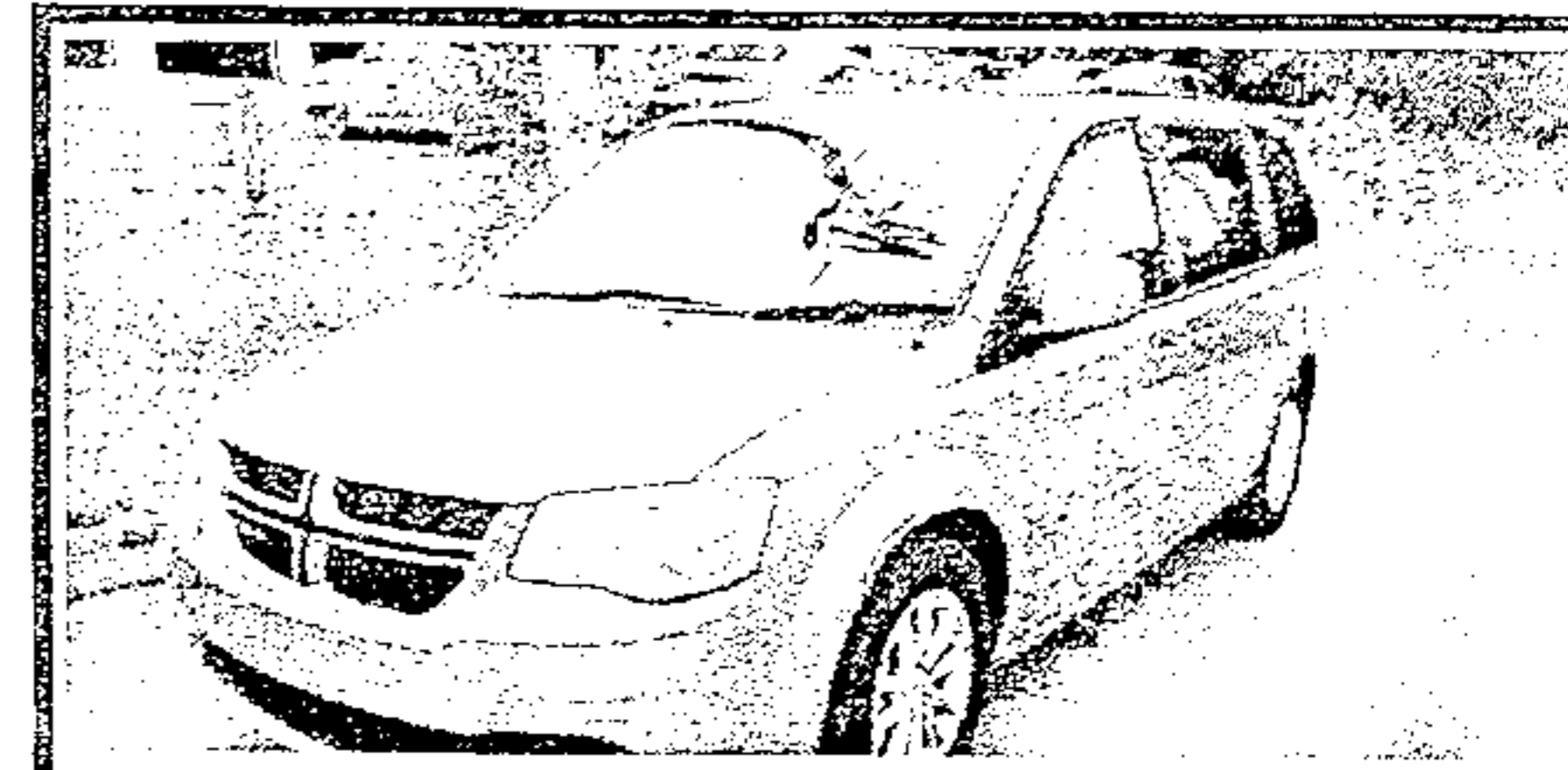

2011 Dodge Grand Caravan DVD, Stow & Go, Loaded, Remote Doors, Rear A/C

DEPENDABLE MOTORS 986-9343

803 E. Broadway • Lenoir City

Serving Loudon County for 20 Years

* WAC. See Dealer for details

Visit our website at: www.dependablemotorslc.com

charged

Carla Grimstead, 44, Montgomery Lane Sweetwater, was charged with Simple Poss x3, and Poss. of Drug Para.

William Lanter, 50, Sunnyside Road Philadelphia,

was charged with Failure to Appear, and Assisting other Agency.

Deputy Cody Fritts LCSO, observed a Green Saturn car traveling on McCrary Street. The passenger in the vehicle did not have a seat belt on.

Upon stopping the vehicle on Pond Creek Road near McCrary Street the driver was identified as Carla Grimstead and the passenger as Robert Lanter II. Upon running Mr. Lanter through dispatch for warrants he was found to have warrants out

of Loudon County and Monroe County. Upon speaking with Ms. Grimstead Deputy noticed signs of intravenous drug use on the inside of her arms. Deputy asked Ms. Grimstead if he could search her vehicle and she agreed.

(see charged ctd. pg. 5)

For Sale: Oak Wood Mulch

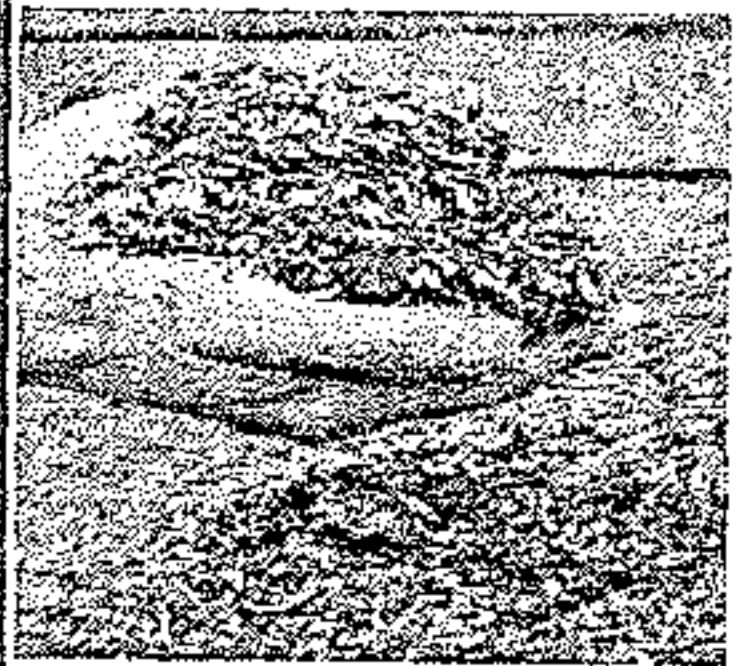

Mushroom Compost Topsoil.

Firewood



Call Steve Spoon
986-4282

The Daily Edition

serving Loudon and surrounding counties since 1986

C&C Lawn Care
Mowing, Mulching, Trimming, Edging, Clear Debris
Free Estimates
Call Chad 865-271-8070

West End Storage & Warehouses
502 Ward Avenue • Loudon
Call 865-458-4774 or 865-679-5555

C&J Towing and Recovery
LOWEST TOWING RATES AROUND!!!

Have you been overcharged for any type of towing service in the Lenoir City area? If you have a breakdown or accident please OWNER REQUEST C&J Towing with the officer. Also please call your Sheriff and ask him to place C&J Towing on the "Rotation List*" and help other motorists save as much as you did! We at C&J are locally owned and operated, State approved, licensed, bonded and insured. Call and let us know if your denied service or how we can be of assistance.

*note: the "Rotation List" is a list of wrecker services that provide service for wrecks, DUI's, breakdowns, etc. and are on an on-call basis for service. This list is approved by the Sheriff.

Cliff Teeters • Owner
865-809-1661

STAINED INK
TATTOO & PIERCING
LENOIR CITY 865 816-6440
NEW OWNER • NEW ARTIST • SINCE 2011
521 Hwy 321 next to Vape & Stuff & Inn Of Lenoir!
Clean-Affordable-Quality-Custom
Tattoo's You've Always Wanted!

BRING IN THIS AD FOR **\$25 OFF**
NEW INK FOR NEW CUSTOMERS ONLY!

Check us out on FB.com/
Stained.Inc.Tattoo/
www.STAINEDINC.com

BIMBO'S
Deli Open 24 Hours
865-986-9643 Call Ins Welcome
Specials
Lg. Cold Sub, bag of chips and 16 oz. fountain drink
only \$6.29
Footlong Corn Dog \$2.59

shootout ctd. from pg. 2
bed of the pickup and the truck was speeding away that Lorenz apparently shot the driver of the truck, Joshua Grubb, as it was entering Hwy 321. The truck travelled into oncoming traffic down the wrong side of Hwy 321 (a four-lane, median divided highway) where it travelled over the highway overpass

above I-75 and impacted a utility pole head-on less than a mile from the point of origin of the incident. Lorenz was apparently unharmed in the bed of the truck and immediately exited the vehicle to render aid to the driver was later pronounced deceased by EMS personnel who responded to the scene.

The other two indi-

viduals who were at the Bimbo's location with Joshua Grubb were Toni Ann Sutton W/F (dob 9-28-1975) of 1213 East Wolf Valley Road, Heiskell, Tennessee and Brandon Lawrence Taylor W/M (dob 10-30-1984) of 152 Barlow Road, Clinton, Tennessee. Sutton was charged by LCPD with possession of drug paraphernalia and Taylor was

charged with public intoxication and evading arrest.

Chief Don White says that Lorenz is on paid administrative leave pending the completion of the investigation. LCPD will be doing a critical incident debriefing with all officers who responded to the scene including Officer Lorenz later this week according to White.

The TBI investigation is ongoing (interviews are continuing, final autopsy results are pending, toxicology results are pending and a forensics analysis of the scene is not yet complete). The District Attorney is awaiting all of these results and is reviewing in car camera video, body camera video and video from Bimbo's. The present plan is to present the results of the TBI investigation to the next meeting of the Loudon County Grand Jury on Monday or Tuesday of April 11th or 12th. Therefore, since it is a pending investigation and to avoid tainting the Grand Jury's review of the case, no further information about the investigation will be released until after the Grand Jury has reviewed it

(see shootout ctd. pg. 5)

Help Wanted

Experienced Dispatcher Needed At Moneymaker Wrecker Service
Apply in person at 11776 Hwy 70, Lenoir City

PUBLIC NOTICE

The Lenoir City Utilities Board is rescheduling their March 2016 Board Meeting which was scheduled for Monday, March 21, 2016, at 4:00 p.m. The new rescheduled time will be Monday, March 28, 2016, at 6:00 p.m. As always, the meeting will be held in the Council Chambers of City Hall located at 600 East Broadway, Lenoir City, Tennessee 37771.

BUDGET Transmissions

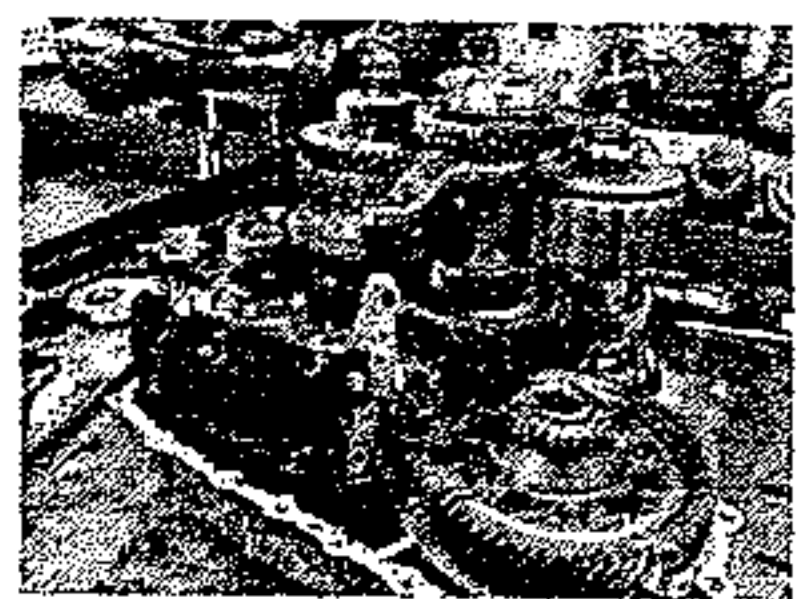

302 S. Northshore Drive Knoxville

(865) 584-4391 budget-transmissions.com

Why Buy From Budget?

- Free Towing From Lenoir City or Loudon County
- 20 Years of BBB Zero Customer Complaints Award Member
- A+ Plus Rated
- Huge Transmission Inventory
- Best Technicians Period!!!
- Call (865) 584-4391 Today!

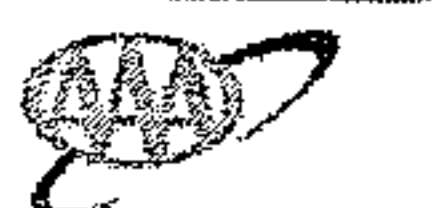

Approved Auto Repair



NEED HELP WITH INCOME TAX? PROFESSIONAL TAX SERVICE

PRICE - 95% of returns between \$60-\$140

(No Coupons Required)

LOCALLY Owned & Operated - Open Year Round

30+ Years in the business

ALL Preparers with 10+ years experience

Pro Tax

111 E. Broadway

Lenoir City, TN 37771

Phone 865-986-4035

**US Armed Service Active Duty Personnel, "THANK YOU", Tax Return Free*

bust

Selena Gribble, 41, Man/Sell/Poss of Controlled Substance.

Deputy Craig Brewer LCSO, was in the area of J.B.'s Country store looking for a blue Chevrolet car he was dispatched to look out for. Deputy found the vehicle sitting the parking lot of J.B.'s Country store and stopped to check on

the driver. On talking with the driver identified as Selena Gribble, Deputy found out she had a suspended license.

On talking with her further Selena gave Deputy verbal consent to search her vehicle.

On searching the vehicle came across her wallet and found a corner of a baggy in it containing 6 round blue pills, identified as

Morphine Sulfate 15 mg. On further search of the vehicle found a note book in the passenger floor board with listings of pill counts and how much for how many pills and list of people and amounts to each.

This did happen in Loudon County Tennessee.

Deputy Craig Brewer LCSO, made the arrest.

blue 2015 Toyota Camry. The robber is approximately 6'2 - 6'3, mid 40s, with a mole on his right cheek. The robber obtained an undetermined amount of money. A red currency dye pack was activated when the robber left the bank.

This matter is being investigated by the Federal Bureau of Investigation (FBI) Safe

Fire

Streets Task Force, comprised of the FBI, Knoxville Police Department (KPD) and Knox County Sheriff's Office (KCSO), and the Knoxville Police Department's Violent Crime Unit. All defendants are presumed innocent unless or until proven guilty beyond a reasonable doubt.

Anyone with information is asked to call the Knoxville FBI Office at 865-544-0751 or the Knoxville Police Department at 865-215-7212.

charged ctd from pg. 3

Found in the driver side floor board in a black case were a baggy of white powder Meth (.2 grams), 2 1/2 white pills with imprint G76 (Opana), and a Marijuana Cigarette. Found in a black make up bag inside Ms. Grimstead purse, were 17 syringes, a pill crusher, a Marijuana pipe, a Spoon, and 4 other small bags with Meth residue. Ms. Grimstead and Mr. Lanter were taken into custody and transported to the Loudon County jail. This did happen in Loudon County. Deputy Cody Fritts LCSO, made the arrest.

shootout ctd. from pg. 4

first. Also, as with all TBI investigations that are ongoing this material is exempt from Public Records requests under TCA 10-7-504(a)(2)(A). Subsequent to that meeting of the Grand

(see shootout conc.. pg. 8)

PURDY'S AUTO PARTS AND SALVAGE

WE BUY SCRAP IRON • COPPER • BRASS • ALUMINUM

\$

Paying Top \$\$\$
Call For Latest Prices

You Name It, We Buy It!

Radiators, Wheels, Batteries, Appliances, Farm Equipment

Copper

Paying Top \$\$\$
Call For Latest Prices

You Call We Haul!

423-519-5402

Prices subject to change with the market.

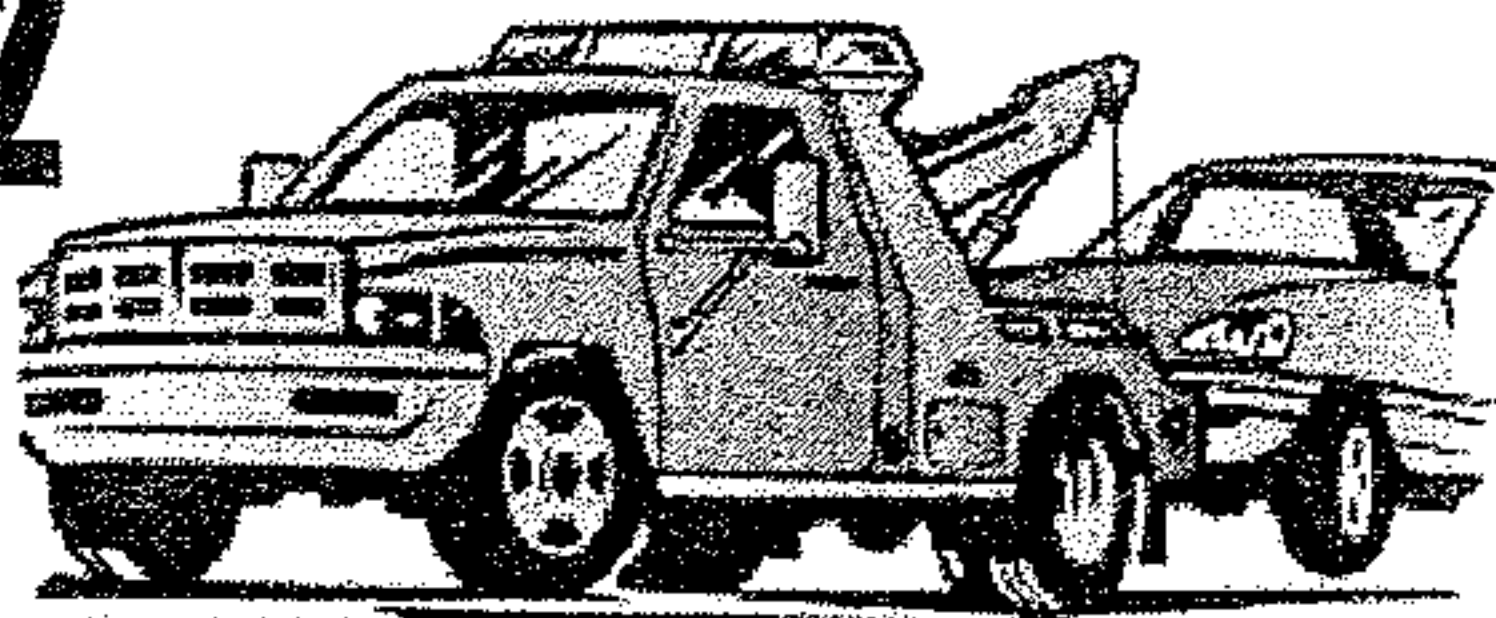

423 337-3977

149 County Road 323 Sweetwater

Complete Cars
per 100 lbs.

Scrap Metal

Paying Top \$\$\$
Call For Latest Prices
per 100 lb

We Buy Batteries

Aluminum Cans

Paying Top \$\$\$
Call For Latest Prices

**Now Selling
Aftermarket
Body Parts at
Discount Prices**

Prices subject to change with the market.

Veterans

Investigators found that Ms. Truss stole money that she collected from visitors and staff who pre-purchased meals from the Veterans' Home cafeteria. Ms. Truss admitted to taking some of the money for her personal use, falsifying accounting records, and destroying receipts.

Investigators identified Ms. Truss as a convicted felon on probation for a previous theft of property over \$60,000 in Hamilton County. While working at the Veterans' Home, she had an outstanding warrant

for her arrest because she had violated the conditions of her probation. Management was unaware of her criminal history, and is now using a different vendor for background checks.

Comptroller investigators also noted \$1,833 in questionable transactions related to residents' trust accounts which Ms. Truss assisted in maintaining.

Additionally, investigators found that

Help Wanted

Position Available Immediately! Apply in person at the Kenjo Marathon on Hwy 321 in Lenoir City.

prescription drugs that should have come to the home were missing. Just prior to Ms. Truss' resignation in August 2014, management found several opened and unopened mail pouches containing various prescription drugs located under her desk.

On March 9, 2016, Marilyn Truss was indicted by the Rutherford County Grand Jury on one count of theft under \$10,000 and one count of making false entries in books or records.

"Many of the problems noted in this investigation could have been prevented with stronger accounting

procedures and management oversight," said Comptroller Justin P. Wilson. "Our report also notes problems with the Veterans' Home purchasing process. I am pleased to see that management has taken steps toward correcting these deficiencies."

To view the investigation online, go to: <http://www.comptroller.tn.gov/ia/>

If you suspect fraud, waste or abuse of public money in Tennessee, call the Comptroller's toll-free hotline at (800) 232-5454, or file a report online at: www.comptroller.tn.gov/hotline. Follow us on twitter @TNCOT

LONNIE JONES OPTICAL DISPENSARY
 "We Make The Difference You Can See"
 Locally Owned and Operated

Over 1000 Frames To Choose From
 No Frame Over \$69.00



On the corner of A & Depot Street, Lenoir City
986-7803
 Serving Loudon County for over 40 years

LOOK! \$75 Weekly Payments LOOK!

MARTY'S AUTO SALES • 986-2222 • MARTY'S AUTO SALES • 986-2222 • MARTY'S AUTO SALES • 986-2222 • MARTY'S AUTO SALES • 986-2222 • MARTY'S AUTO SALES •

Bad Credit
Divorce
Fixed Income
Repos
Bankruptcy
No Credit

APPROVED! **NO CREDIT CHECKS**

Visit Us On The Web At:
martysautosales.net

 <p>\$99 down*</p> <p>97 Escort, auto, gas saver Only \$99 down*</p>	 <p>\$299 down*</p> <p>03 Taurus, runs good, Only \$299 down*</p>	 <p>\$199 down*</p> <p>99 Venture, 7 passenger, Only \$199 down*</p>	 <p>\$499 down*</p> <p>01 Sebring 2dr. sporty, Only \$499 down*</p>
 <p>\$599 down*</p> <p>05 Trailblazer, auto, good miles Only \$599 down*</p>	 <p>\$499 down*</p> <p>04 Aveo, auto, gas saver, Only \$499 down*</p>	 <p>\$799 down*</p> <p>06 Tiburon GT, 5 speed, sporty, Only \$799 down*</p>	 <p>\$99 down*</p> <p>98 Bonneville, 6 cyl, Auto, low payments only \$99 down*</p>

NO Credit Checks **Marty's Auto Sales** **100% Approval***
986-2222 Se Habla Espanol

*See Dealer for details. All down payments plus tax, tag, title and fees.

MARTY'S AUTO SALES • 986-2222 • MARTY'S AUTO SALES • 986-2222 • MARTY'S AUTO SALES • 986-2222 • MARTY'S AUTO SALES • 986-2222 • MARTY'S AUTO SALES •

shootout conc. from pg. 5
 Jury and depending on the Grand Jury's decision the District Attorney after consultation with TBI legal staff may release relevant portions of the investigation, including video footage to the media and will post same to the office's website for public viewing and inspection.

THE RELIC SHOP

521 Hwy 321 Lenoir City Suite 3
 next to Stained Inc and the Inn of Lenoir
865-250-9280

HUGE NEW SELECTION OF FOSSILS, ARTIFACTS,
 COINS, AND MORE

ALL AMETHYST 40% OFF

GREAT SELECTION OF ANCIENT MEGALADON
 SHARK TOOTH OVER 8 MILLION YEARS OLD

Is Your Washer Broken?

Call Me

I Only Charge \$100 Period!!!

Call Allen

865-617-7113

A Name You Already Know And Trust Just Got Even More Dependable
DEPENDABLE AUTO SERVICE, LUBE AND TIRES
is Now Offering
Expert, Affordable Transmission Service

All ASE Certified Technicians

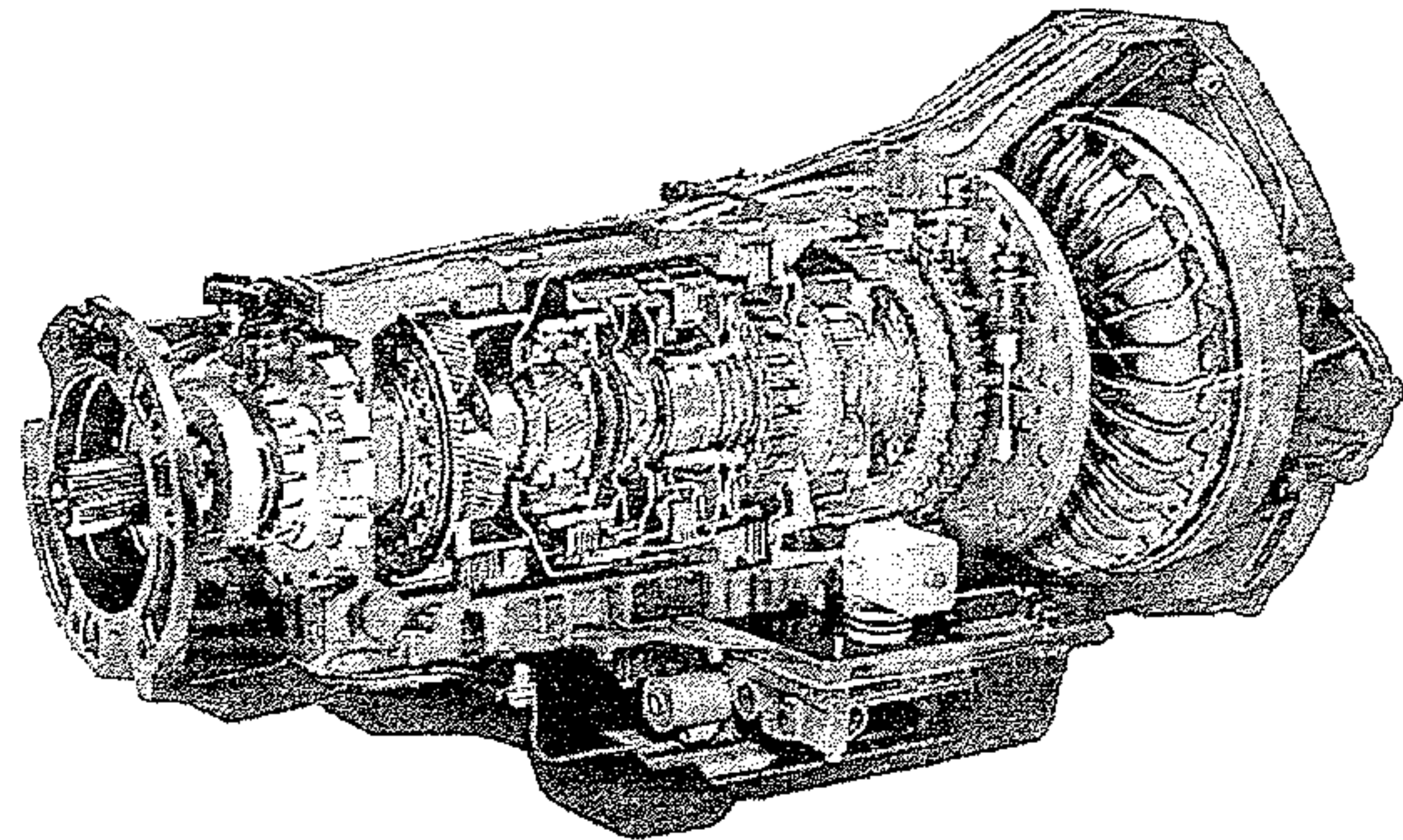

We proudly welcome all New Customers
 and Former Advanced Transmission
 Customers with a 10% Discount and Any
 Transmission Service or Repair*

865-986-9359

865-986-5050

Bad Credit, No Credit OK!!! We Finance Everybody!!!

Taxes Done Here!!! Bring your last pay stub or W2 and DRIVE TODAY!!!

Over 100 Cars, Trucks & Vans in Stock - Warranties On ALL Vehicles Sold!!!



2007 Chevrolet Uplander,
 60k miles, NICE!!!

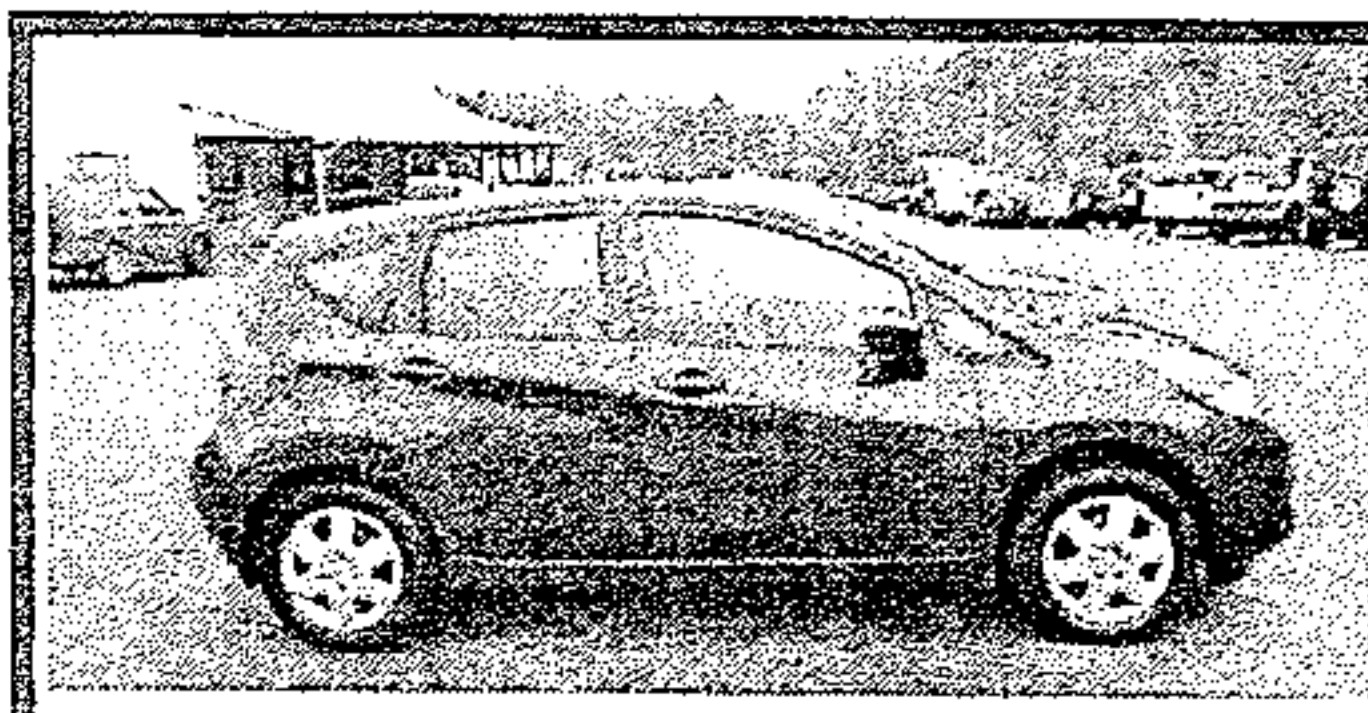

2015 Nissan Versa Note, Fac-
 tory Warranty, Low Miles

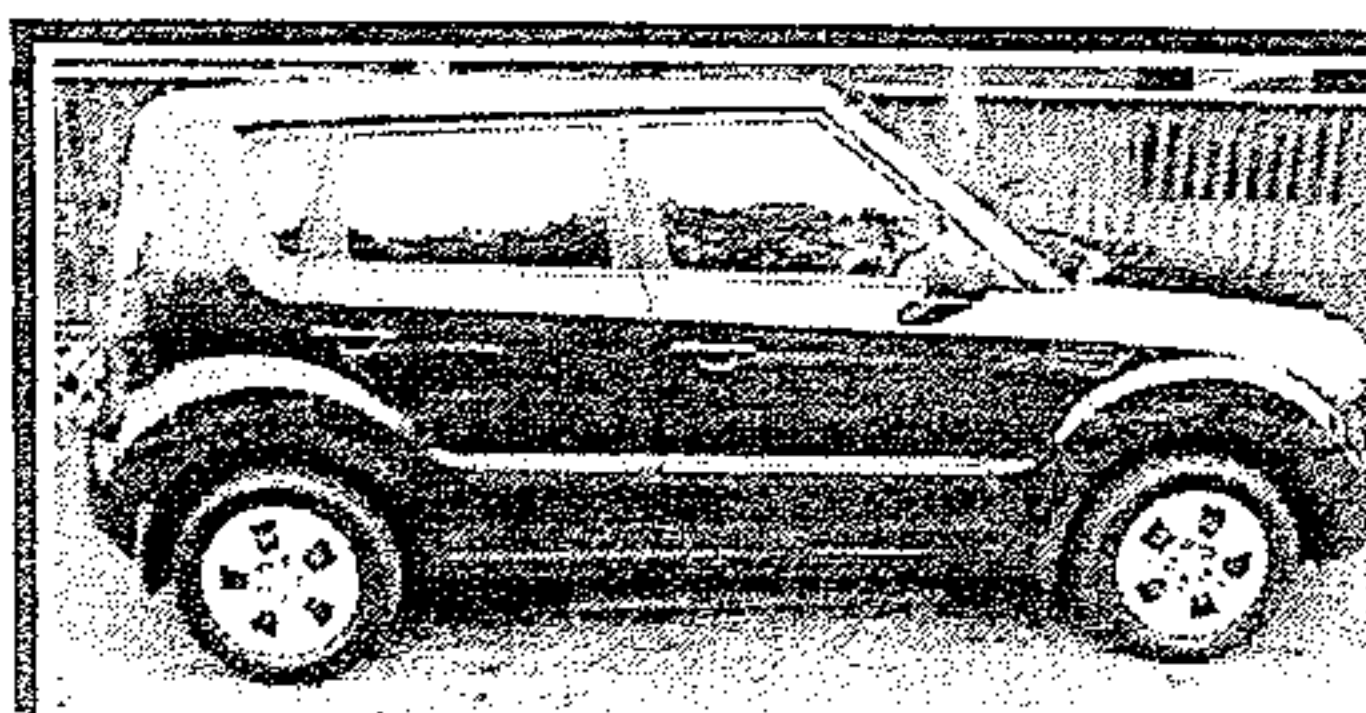

2011 Kia Soul, 5 speed, 4 dr,
 Gas Saver, Nice & Clean



2008 Saturn VUE, LOADED!!!
 4dr, Ready to go on a trip!

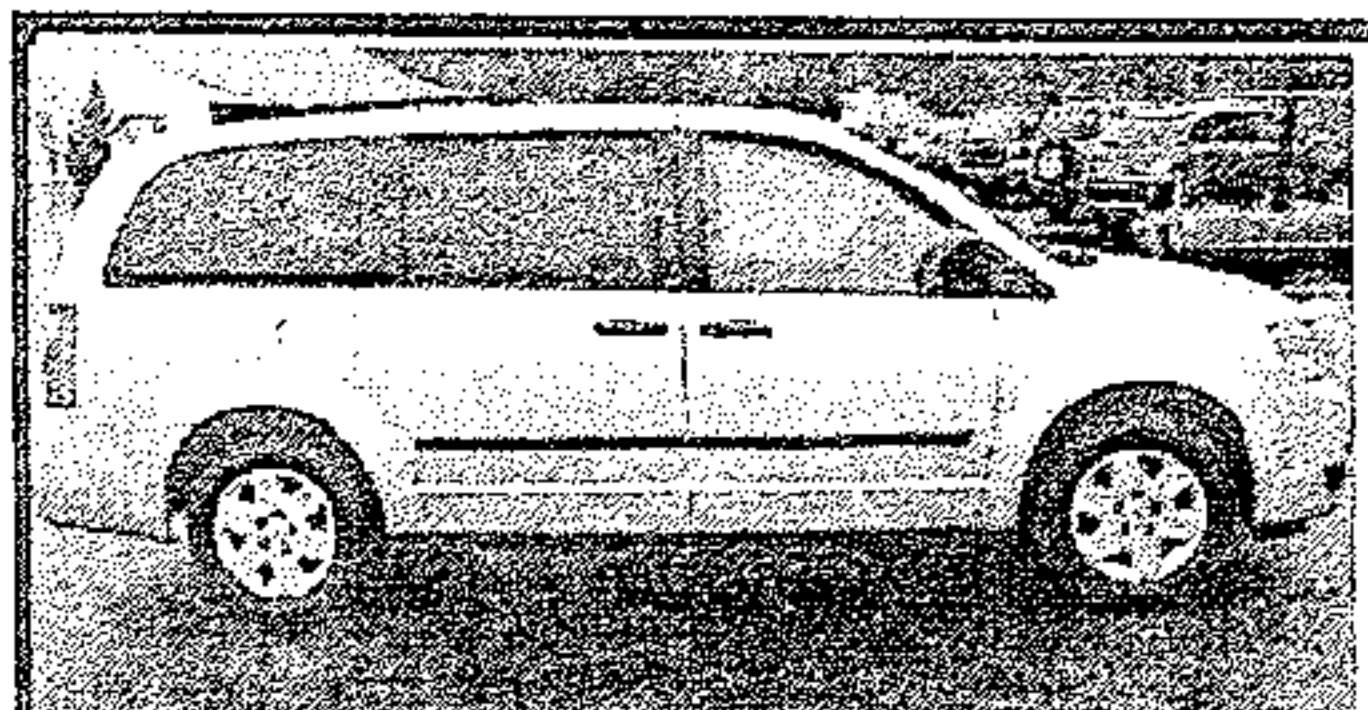

2008 Dodge Grand Caravan,
 Nice, Clean, Stow n Go!

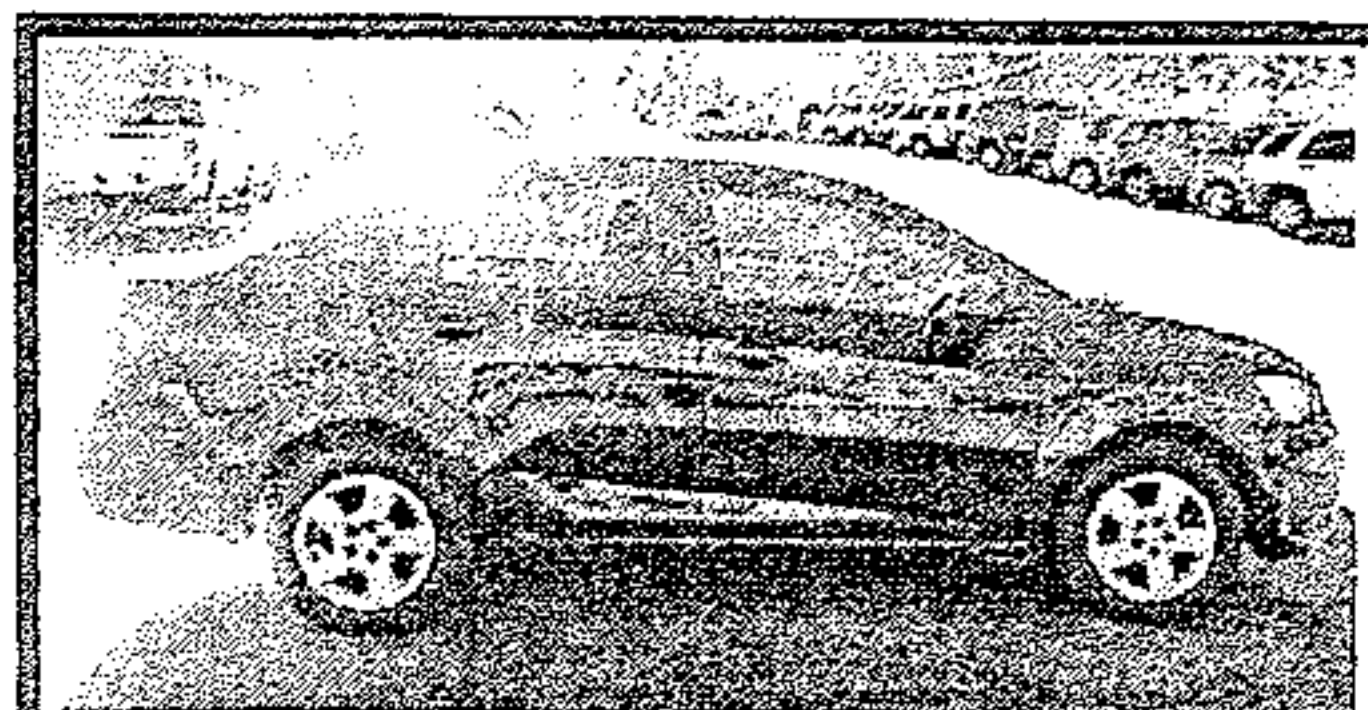

2014 Chevy Sonic, Factory
 Warranty, Low Miles!



Mitsubishi Raider, Ext. Cab,
 Super Nice Truck

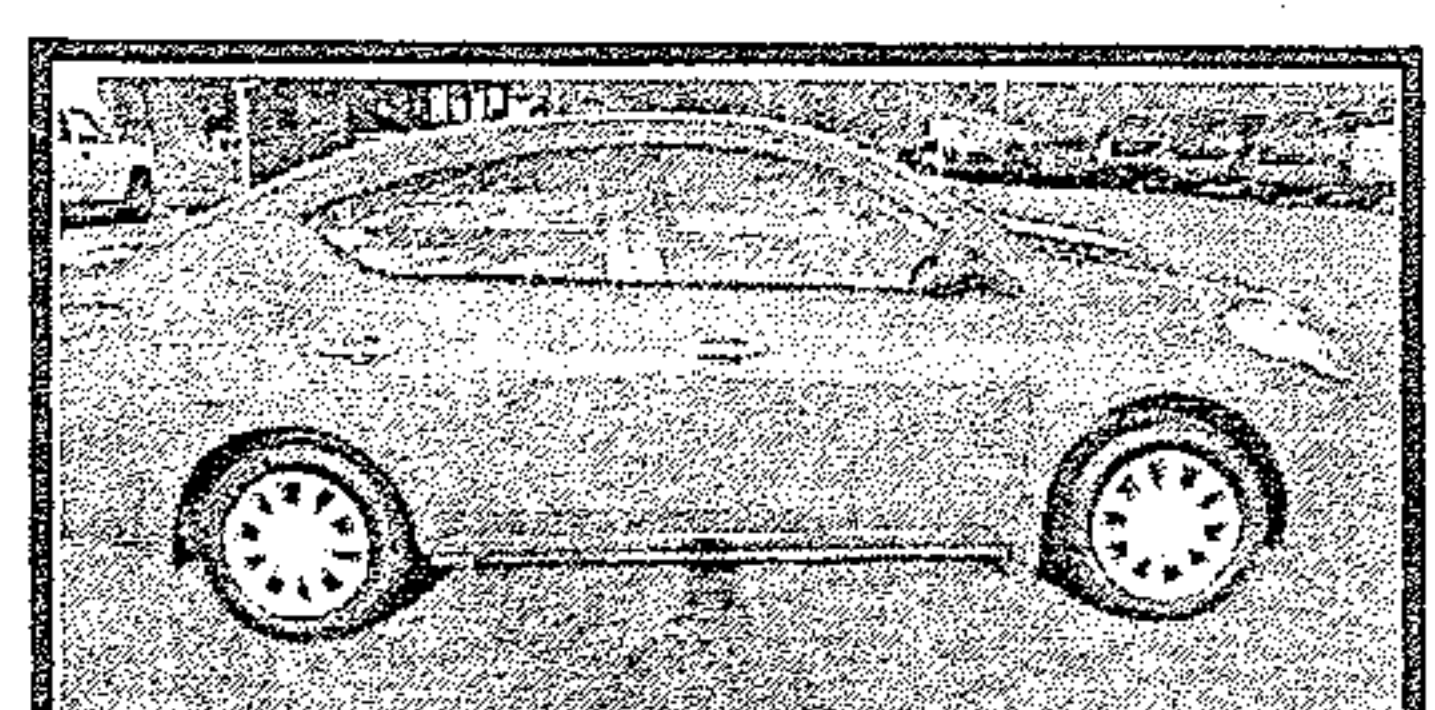

2013 Nissan Versa, Like New!
 LOADED!!!

WALT WILLIAMS, INC.

*with approved credit

3003 Highway 11 Lenoir City, TN **865-986-1111**