

The Daily Edition

50¢

Serving Loudon, Monroe and Surrounding Counties

Monday, March 14, 2016

Drugs for resale, firearm and more found during LCSO stop

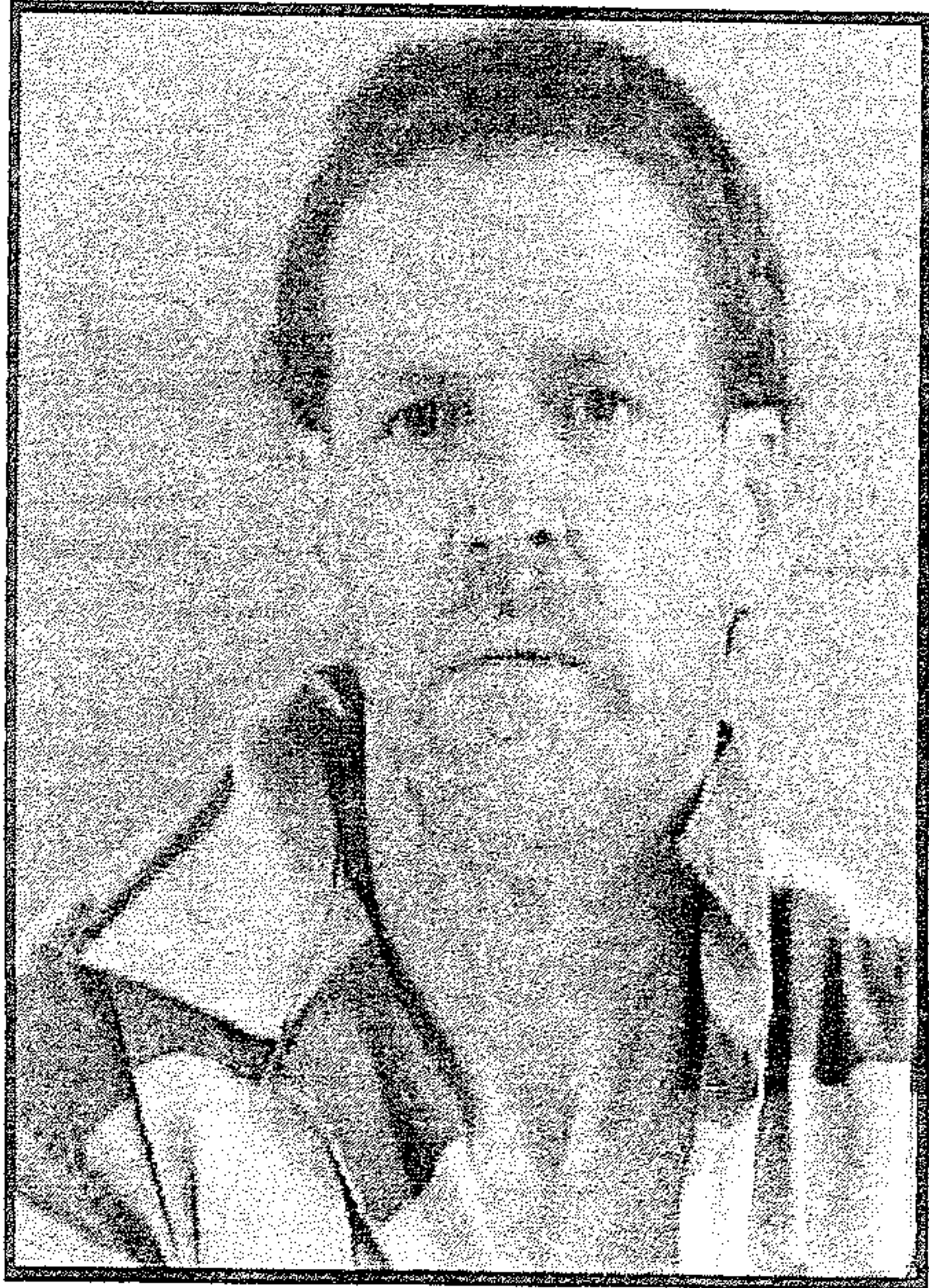

Jeffrey Elsea

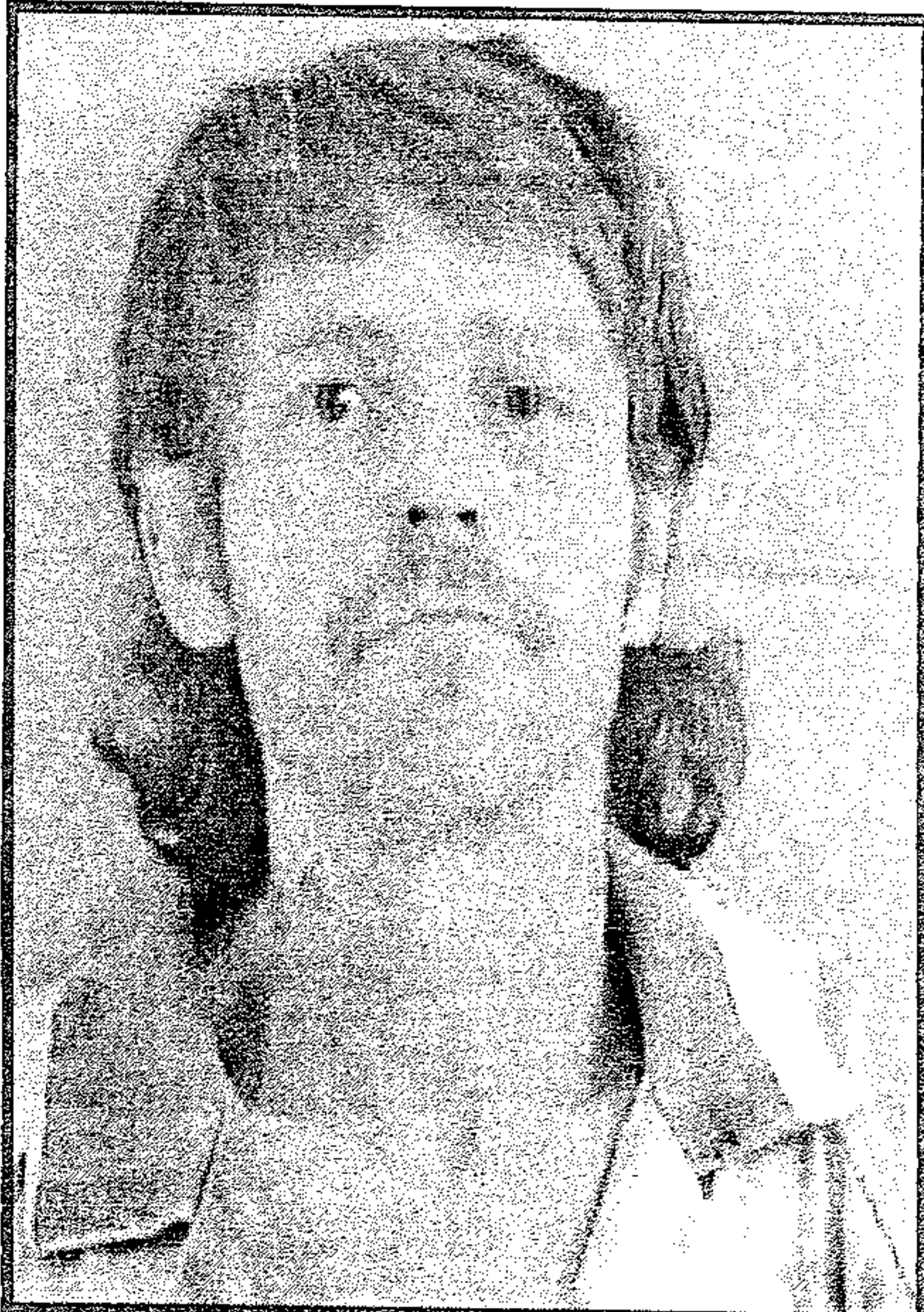

Jason Rinehart (see LCSO pg. 2)

Joshua Hayworth sentenced to more than 16 years in prison for Hobbs Act Robbery and Carjacking

Joshua Hayworth, 25, of Loudon, Tenn., was sentenced on March 10, 2016, by the Honorable Thomas A. Varlan, U.S. District Court Chief Judge, to serve 200 months in federal prison.

After a jury trial in July 2015, Hay-
(see sentenced pg. 7)

FATALITY FIRE INVESTIGATION

The Loudon County Sheriff's Office, along with the Tennessee Bomb and Arson Division, are investigating a house fire involving a fatality. On Wednesday, March 9, 2016, at approximately 2:30 pm, the fire at 17735 Vonore Road in Loudon, TN was reported to E911. The sole victim has been identified as Richard Todd Dirksen, age 60, who lived alone.

(see fire pg. 5)

Suspended driver adds charge at the jail

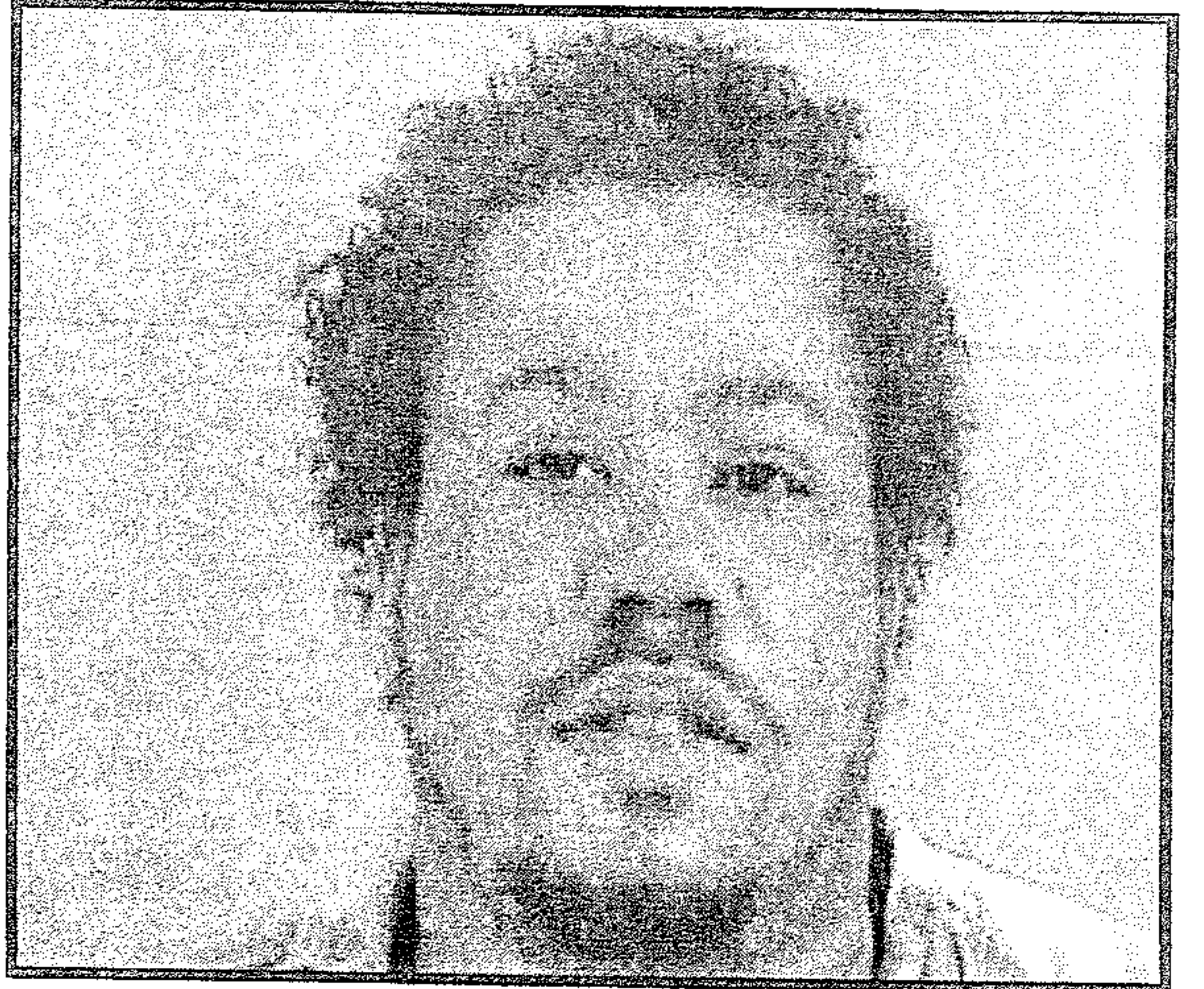

Donald McCoy (see charge pg. 5)

Man throws all kinds of items during assault

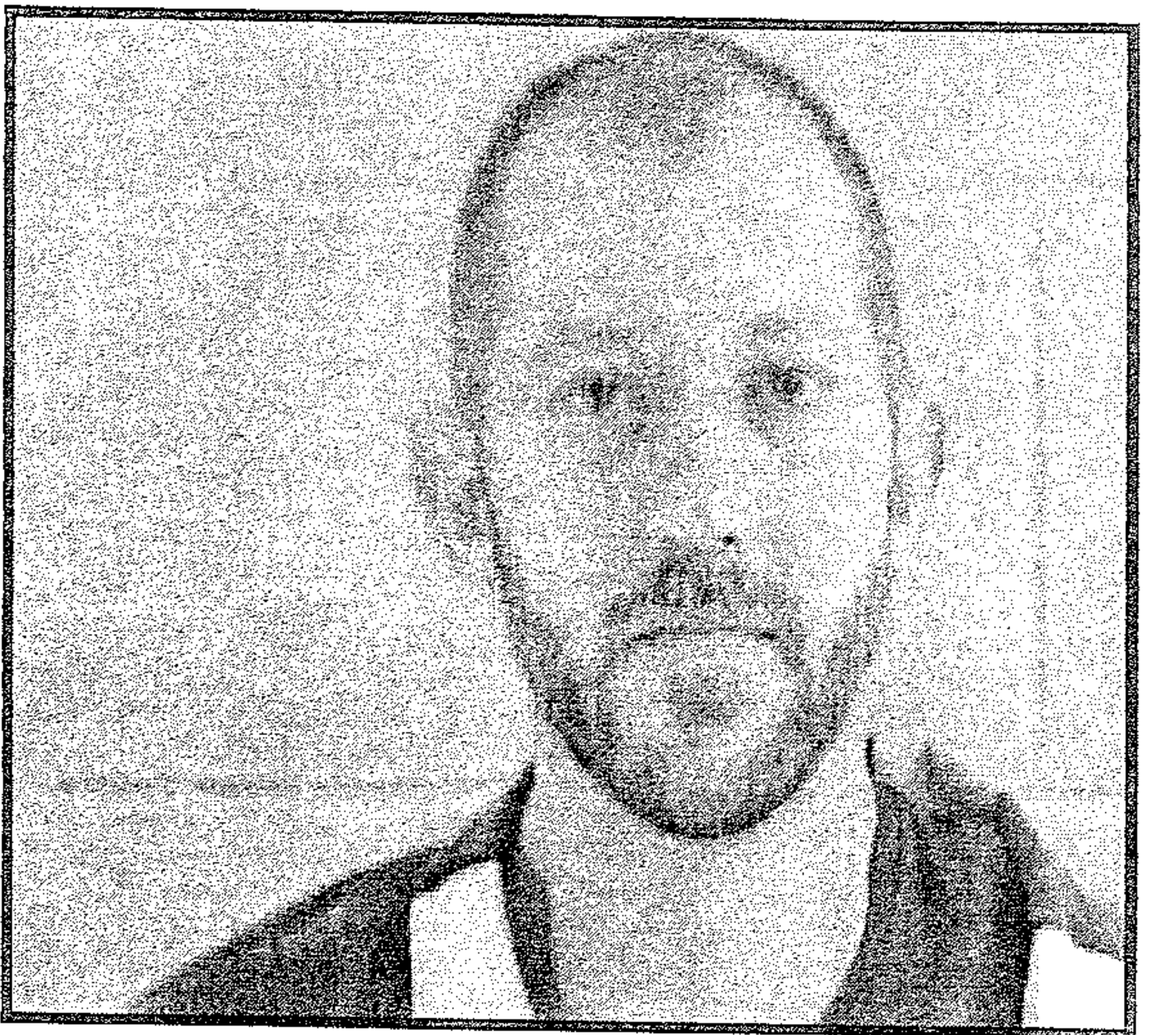

Jamie Couch (see assault pg. 3)

Verse of the Day

For no one can lay any foundation other than the one already laid, which is Jesus Christ. — 1 Corinthians 3:11

Obituaries

see inside
Wazzup
March Madness is Here Baby!!! Dont' for the St. Patricks Day celebration too!!!

Weather

Today: Mixed clouds and sun with scattered thunderstorms. High 72F.
Tonight: Partly cloudy skies. Low 51F.
Tuesday Sunny skies. High 79F.
Tuesday Night Partly

cloudy. Low near 50F.

Horoscopes

Pisces 2/19-3/20

It is a tortoise-and-the-hare kind of day -- and you are now playing the role of both of these characters. You're off to a quick start

(Continued on page 6)



LCSO

Jeffery Elsea, 46, East Farrelle Niota, was charged with Man/Sell/Del/Resale SCH. II, Poss. of a Firearm During a Dangerous Situation, Contraband in a Penal Institution, Prohibited Weapons, Simple Possession, and Poss. of Drug Para.

Jason Rinehart, 43, Green-

wood Circle Madisonville, was charged with Man/Sell/Del/Resale SCH. II, Contraband in a Penal Institution, Prohibited Weapon, Simple Poss., and Poss. of Drug Para..

Cpl. Chris Hutchens LCSO, observed a vehicle turn onto Spring Street from Hwy 11. There were two males in the

(see LCSO ctd. pg. 4)

Call 865-771-2249 to Advertise and start saving today!
Has your group got an event coming up?
Let us know!!!

To Get a Burning Permit:
 Loudon (865) 986-8395
 Monroe (423) 442-7401
 Roane (865) 354-1054

Notice: The Daily Edition does not knowingly accept fraudulent or misleading materials. The Daily Edition cannot guarantee the validity of offerings or statements contained herein. All liability for the contents of all advertising, and for any claims that may arise therefrom, is the responsibility of the advertiser or its agency. The Daily Edition reserves the right to reject, edit, or abbreviate any advertisement submitted. Advertising is accepted with the understanding that all liability for all copyright violations is the sole responsibility of the advertiser. Photographs, artwork and other copy submitted for publication is considered the sole property of the advertiser. The Daily Edition will make every effort but will not be liable for failure to publish and ad or for typographical and layout errors. All statements and information about highlights featured items, letters to the editor, herein are those solely given to the interviewer or writer and the Daily Edition assumes no responsibility of the accuracy or validity thereof. The Daily Edition will gladly reprint at no charge that part of an advertisement in which an error occurs provided a claim is made within 3 days of the first publication of the ad. Information contained in the Wazzup is received anonymously and the Daily Edition assumes no responsibility for information and reserves the right to edit or reject any and/or all submissions. The Daily Edition is a daily newspaper of general circulation in Loudon County defined under TCA 2-1-104(a)(13). The Daily Edition also serves Monroe, Knox, Anderson, Roane and Blount counties and serves 30,000 readers weekly. Send mail to PO Box 1240, Lenoir City TN 37771. 865-771-2249. email: dan1204us@yahoo.com

The Daily Edition is Loudon County's premier public interest and paid advertising paper. The Daily Edition is produced and published daily Monday through Friday and is circulated throughout Loudon County and parts of Monroe and Knox Counties. Display advertising rates \$5.00 per column inch and quantity discounts available. Call for information on upcoming promotions and events.

HACIENDA Ayala's
Mexican Restaurant
 Market Dr. * Lenoir City (In Front of Food City)

Real Authentic Mexican Food at Affordable Prices

BEST MARGARITA

You've Tried The Rest
 Now Come Have The Best!!!

We Accept ALL Competitors Coupons Outside of Mexico City!

986-3553



Good Credit OK • Bad Credit OK • Bankruptcies OK • Repo OK



2010 Kia Soul Sporty, 4 cyl, Auto, PW, PL, A/C, Great On Gas, Like New



2010 Ford Escape Limited Leather, Alloy Wheels, Heat, A/C, Luggage Rack, 79K,



2007 Dodge Ram 1500 Quad Cab, Thunder Road PKG, 20 in. Wheels, Low Miles, Hemi



2008 Ford Explorer 84k, 3rd Row Seating, Luggage Rack, Tow Pkg, PW, PL



2011 Ford Ranger Low Miles, Tow Pkg, New Tires, A/C, Heat, Bed Liner.



2011 Dodge Grand Caravan DVD, Stow & Go, Loaded, Remote Doors, Rear A/C

DEPENDABLE MOTORS 986-9343
 803 E. Broadway • Lenoir City

Serving Loudon County for 20 Years

* WAC. See Dealer for details

Visit our website at: www.dependablemotorslc.com

assault

Jamie Brian Couch, 37, Watkins Road, Loudon, was charged with domestic assault.

Deputy Mark Tinnel LCSO, was dispatched to Watkins Road, Loudon, TN on a call

of domestic assault.

Upon arrival, Deputy spoke with the complainants/victim. Victim advised that she had got into an argument with her husband, Jamie B. Couch. She stated that the argument was over Mr. Couch talking to another female over Facebook. She stated that when she attempted to get his phone, he got mad and threw her across the room, hit her in the head, and took her phone, saying that he would kill her. She stated that she then ran outside of the house, where Mr. Couch went after her throwing a golf club and pogo stick at her. She stated she got in her car, and Mr. Couch dragged her out of it,

hitting her in the head. Victim did have visible swelling on her forehead. and the golf club was laying near the car. Mr. Couch was taken into

custody for domestic violence assault, and transported to the Loudon County Jail. Deputy Mark Tinnel LCSO, made the arrest.

For Sale: Oak Wood Mulch

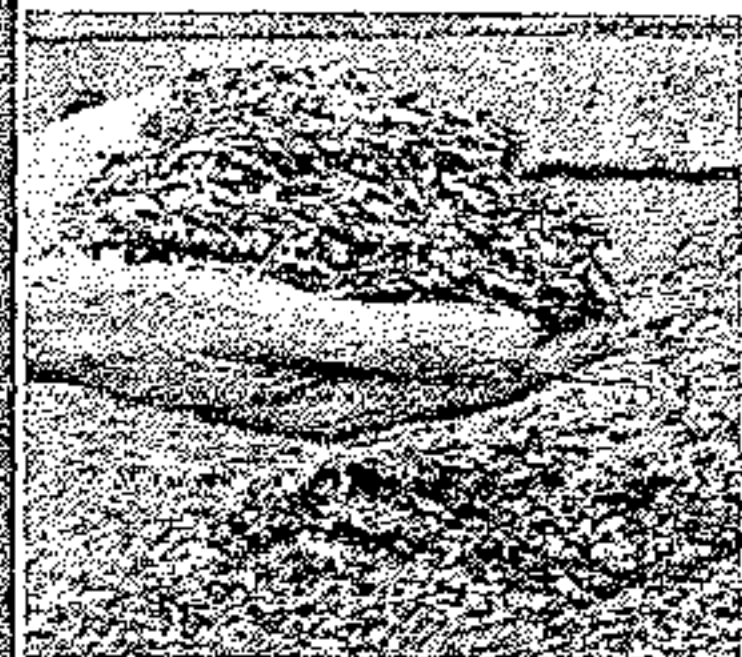

Mushroom Compost Topsoil.

Firewood



Call Steve Spoon
986-4282

The Daily Edition
serving Loudon and surrounding counties since 1986

C&C Lawn Care
Mowing, Mulching, Trimming, Edging, Clear Debris
Free Estimates
Call Chad 865-271-8070

West End Storage & Warehouses
502 Ward Avenue • Loudon
Call 865-458-4774 or 865-679-5555

C&J Towing and Recovery
LOWEST TOWING RATES AROUND!!!

Have you been overcharged for any type of towing service in the Lenoir City area? If you have a breakdown or accident please OWNER REQUEST C&J Towing with the officer. Also please call your Sheriff and ask him to place C&J Towing on the "Rotation List*" and help other motorists save as much as you did! We at C&J are locally owned and operated, State approved, licensed, bonded and insured. Call and let us know if your denied service or how we can be of assistance.

*note: the "Rotation List" is a list of wrecker services that provide service for wrecks, DUI's, breakdowns, etc. and are on an on-call basis for service. This list is approved by the Sheriff.

Cliff Teeters • Owner
865-809-1661

STAINED INK
TATTOO & PIERCING
LENOIR CITY 865 816-6440
NEW OWNER • NEW ARTIST • SINCE 2011
521 Hwy 321 next to Vape & Stuff & Inn Of Lenoir!
Clean-Affordable-Quality-Custom
Tattoo's You've Always Wanted!

BRING IN THIS Ad FOR **\$25 OFF!**
NEW INK FOR NEW CUSTOMERS ONLY!

Check us out on FB.com/
Stained.Inc.Tattoo/
www.STAINEDINC.com

BIMBO'S
Deli Open 24 Hours
865-986-9643 Call Ins Welcome

Specials
Lg. Cold Sub, bag of chips and 16 oz. fountain drink
only \$6.29
Footlong Corn Dog \$2.59

LCSO ctd. from pg. 2
 vehicle and the passenger was not wearing a seatbelt. Deputy conducted a traffic stop, and made contact with the driver Jason Rinehart, and the passenger Jeffery Elsea. Jeffery stated that they were riding around and came to drop some money off to his daughter. Both parties were very nervous during the encounter, and Jeffery's phone rang continuously during the stop. Deputy ask both parties were ask to exit the vehicle and Jeffery stated there was a handgun underneath the seat. Once both parties exited the vehicle Deputy secured the weapon. A check revealed Jeffery to have an active warrant out of McMinn. Deputy deployed his
 (see LCSO ctd. pg. 5)

Help Wanted

**Experienced
 Dispatcher
 Needed At
 Moneymaker
 Wrecker Service**
 Apply in person
 at 11776 Hwy
 70, Lenoir City

BUDGET *Transmissions*

302 S. Northshore Drive Knoxville

(865) 584-4391 budget-transmissions.com

Why Buy From Budget?

- Free Towing From Lenoir City or Loudon County
- 20 Years of BBB Zero Customer Complaints Award Member
- A+ Plus Rated
- Huge Transmission Inventory
- Best Technicians Period!!!
- Call (865) 584-4391 Today!

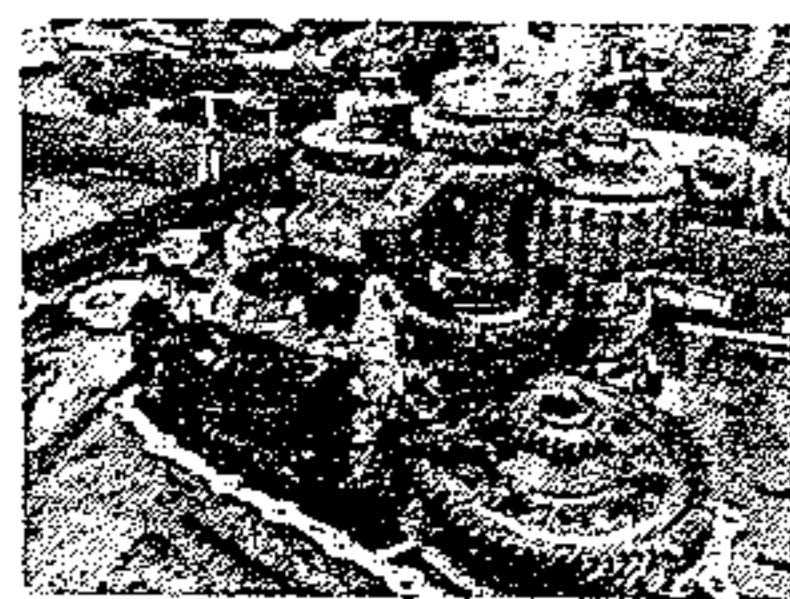

Approved Auto Repair



NEED HELP WITH INCOME TAX? PROFESSIONAL TAX SERVICE

PRICE - 95% of returns between \$60-\$140

(No Coupons Required)

LOCALLY Owned & Operated - Open Year Round

30+ Years in the business

ALL Preparers with 10+ years experience

Pro Tax

**111 E. Broadway
 Lenoir City, TN 37771
 Phone 865-986-4035**

**US Armed Service Active Duty Personnel, "THANK YOU", Tax Return Free*

good
 to know
 you™

IMMEDIATE OPENINGS!

Randstad is NOW HIRING for 2nd shift Assembly Positions at Commercial Vehicle Group. These are long-term, temp-to-hire positions!

Hours: 4:30pm - 3:30am (end times vary)

Pay: \$10/\$10.50 per hour

You may apply by visiting our Facebook page www.facebook.com/vonorejob and clicking the "Sign Up" button. You can also get a paper application from the Guard Shack at 200 National Drive, Vonore, TN 37885.

For questions, call 423.884.4733

www.randstadstaffing.com

EOE



Staffing | Professionals | Search & Placement | HR Solutions | Inhouse Services

charge

Donald Edeard McCoy, 38, of Agnes Street, Knoxville, was charged with driving on revoked/suspended license and contraband in a penal institution.

Officer Nick Halsey LCSO, initiated a traffic stop on Donald Edward McCoy for a registration violation. Upon further investigation it was made known

to Officer that Mr. McCoy was operating the motor vehicle on a suspended driver license. Mr. McCoy was then taken into custody and transported to the Loudon Co jail without incident. Upon entering the jail to be searched, Mr. McCoy stated that he had marijuana inside his pants on his person after Officer asked him if he had anything else on him. Options were

explained to Mr. McCoy. Officer Nick Halsey LCPD, made the arrest.

Fire

An autopsy has been performed and the investigation is ongoing at this time.

GOOD SHEPHERD CENTER DINNER AND AUCTION

The Good Shepherd Center of Monroe County will hold

its annual fund raising Dinner and Auction on April 2, 2016.

The location will be at the Tellico West Conference Center, 121 Grand Vista, Vonore TN 37885.

The silent auction will begin at 5:30 PM and the catered dinner will be at 6:30 PM.

Entertainment will be the dynamic singing duo known as Vocal Point.

Tickets are \$40 each, of which 20 dollars is income

tax deductible. For those who wish to support the Good Shepherd but are unable to attend this function, there are Feed a Family tickets available, also \$40 each.

Tickets may be purchased at The Good Shepherd Center, The Monroe County Chamber of Commerce, the Kahite Club House and individual Good Shepherd volunteers.

The Good Shepherd Center is a 501©3 organization.

Some of the things The Good Shepherd Center provides are food to over 2,100 men, women and children every month, personal care items as requested, clothing to each person per household, miscellaneous items each month, transportation via ETHRA for medical appointments, emergency housing for fire victims, layette sets for newborn babies and utility vouchers.

The Good Shepherd Center is supported financially by churches, local businesses, and individuals. Additional funds are provided through grants, auxiliary groups, Monroe County governmental agencies and fundraising events such as this Dinner/Auction event.

LCSO ctd. from pg. 4

partner K-9 Dante to sniff the vehicle and he did alert. During a search of the vehicle in the backseat a camera case was found with two clear baggies, one containing meth and the other marijuana, and a meth pipe. Beside the driver seat and console was a set of brass knuckles, accessible to both parties. Both parties were placed under arrest. Once at the jail both were search and located on Jeffery

(see Lcso conc.. pg. 8)

PURDY'S AUTO PARTS AND SALVAGE
WE BUY SCRAP IRON • COPPER • BRASS • ALUMINUM

\$ **Paying Top \$\$\$**
Call For Latest Prices

You Name It, We Buy It!

Radiators, Wheels, Batteries, Appliances, Farm Equipment

Copper
Paying Top \$\$\$
Call For Latest Prices

Complete Cars
per 100 lbs.

Scrap Metal
Paying Top \$\$\$
Call For Latest Prices
per 100 lb

We Buy Batteries

Aluminum Cans
Paying Top \$\$\$
Call For Latest Prices

Now Selling
Aftermarket
Body Parts at
Discount Prices

You Call We Haul!
423-519-5402

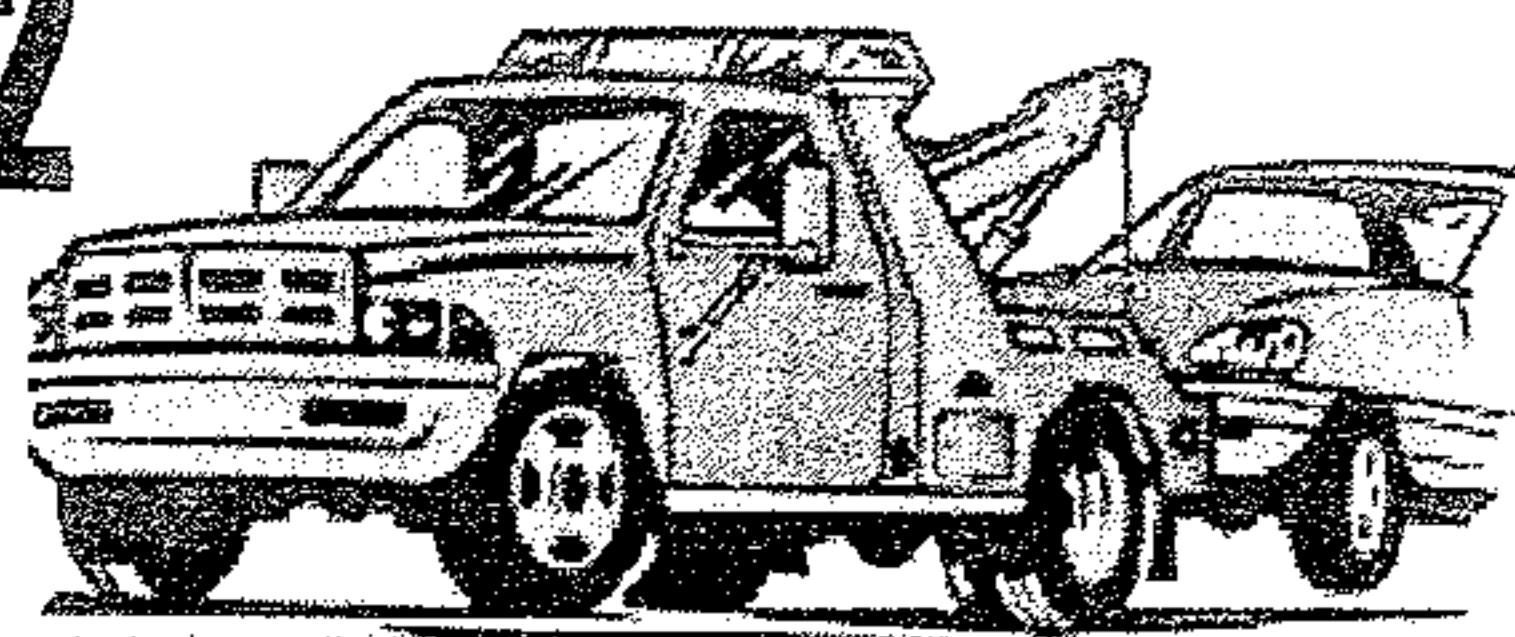

Prices subject to change with the market.

423 337-3977
149 County Road 323 Sweetwater

Prices subject to change with the market.

sentenced

worth was convicted of a Hobbs Act robbery at the Burger King located on Simpson Road in Lenoir City, Tenn., which occurred on Jan. 30, 2014, and a carjacking in Knoxville, Tenn., which occurred on Feb. 3, 2014. The trial evidence showed that during the Burger King robbery, Hayworth brandished an airsoft pistol and, while pointing the pistol at the employees, ordered them to fill up a bag with money from the safe. His co-defendant, Timothy Chudley, was employed at the Burger King and, unbeknownst to his

co-workers, was in on the robbery. During the commission of the robbery, Hayworth hit Chudley in the head with his pistol, causing Chudley to bleed. Hayworth fled the Burger King in a vehicle that he wrecked less than one mile from the Burger King. He left the accident scene before law enforcement arrived, but the trial evidence revealed that the vehicle contained: the pistol used during the robbery;

Help Wanted

Position Available Immediately! Apply in person at the Kenjo Marathon on Hwy 321 in Lenoir City.

the robber's mask, which contained Hayworth's DNA; Hayworth's identification card; and prescription medication in Hayworth's name. Cash from the robbery was also recovered from within the wrecked vehicle and all over the highway. Finally, Hayworth's cellular telephone, which contained text messages to and from Chudley that showed their planning of the robbery, was also recovered.

Although law enforcement searched for Hayworth, he was not found on the night of the Burger King robbery. Trial evidence revealed that four days

after the Burger King robbery, Hayworth carjacked a pregnant woman in Knoxville, Tenn., who was less than one week away from delivering her baby. After he violently wrestled the keys away from her, the pregnant victim had to endure an agonizing wait for an ambulance as she feared that her full-term baby, who was not moving, was dead. Upon arriving at the hospital, it was discovered that the baby was, in fact, healthy.

Agencies involved in this investigation include the Federal Bureau of Investigation (FBI) Safe Streets Task Force, which is made

up of agents with the FBI and officers from the Knoxville Police Department and Knox County Sheriff's Office; Knoxville Police Department; Knox County Sheriff's Office Major Crimes Unit; Loudon County Sheriff's Office, and Lenoir City Police Department. Assistant U.S. Attorneys Kelly A. Norris and Cynthia F. Davidson represented the United States.

We Want To Buy TRACTS of TIMBER
for an onsite quote
Call or text
423-371-0999
email: buytimber@outlook.com

LOOK! \$75 Weekly Payments LOOK!

MARTY'S AUTO SALES • 986-2222 • MARTY'S AUTO SALES • 986-2222 • MARTY'S AUTO SALES • 986-2222 • MARTY'S AUTO SALES • 986-2222 • MARTY'S AUTO SALES •

Bad Credit
Divorce
Fixed Income
Repos
Bankruptcy
No Credit

APPROVED! **NO CREDIT CHECKS**

Visit Us On The Web At:
martysautosales.net

 <p>\$99 down*</p> <p>97 Escort, auto, gas saver Only \$99 down *</p>	 <p>\$299 down*</p> <p>03 Taurus, runs good, Only \$299 down *</p>	 <p>\$199 down*</p> <p>99 Venture, 7 passenger, Only \$199 down *</p>	 <p>\$499 down*</p> <p>01 Sebring 2dr. sporty, Only \$499 down *</p>
 <p>\$599 down*</p> <p>05 Trailblazer, auto, good miles Only \$599 down *</p>	 <p>\$499 down*</p> <p>04 Aveo, auto, gas saver, Only \$499 down *</p>	 <p>\$799 down*</p> <p>06 Tiburon GT, 5 speed, sporty, Only \$799 down *</p>	 <p>\$99 down*</p> <p>98 Bonneville, 6 cyl, Auto, low payments only \$99 down *</p>

NO Credit Checks *Marty's Auto Sales* **986-2222** **100% Approval*** *Se Habla Español*

*See Dealer for details. All down payments plus tax, tag, title and fees.

MARTY'S AUTO SALES • 986-2222 • MARTY'S AUTO SALES • 986-2222 • MARTY'S AUTO SALES • 986-2222 • MARTY'S AUTO SALES • 986-2222 • MARTY'S AUTO SALES •

LCSO conc. from pg. 5
 were 5 small baggies
 of meth in his socks.
 and Jason Rinehart
 had 2 small baggies
 of meth inside his hat
 he was wearing. Cpl.

Chris Hutchens LCSO,
 made the arrest.

To Advertise for
 as low as \$1 per
 day. Call
 865-771-2249

THE RELIC SHOP

521 Hwy 321 Lenoir City Suite 3
 next to Stained Inc and the Inn of Lenoir
865-250-9280

HUGE NEW SELCTION OF FOSSILS, ARTIFACTS,
 COINS, AND MORE

ALL AMETHYST 40% OFF

GREAT SELECTION OF ANCIENT MEGALADON
 SHARK TOOTH OVER 8 MILLION YEARS OLD

Is Your Washer Broken?

Call Me

I Only Charge \$100 Period!!!

Call Allen

865-617-7113

A Name You Already Know And Trust Just Got Even More Dependable
DEPENDABLE AUTO SERVICE, LUBE AND TIRES
Is Now Offering
Expert, Affordable Transmission Service

All ASE Certified Technicians

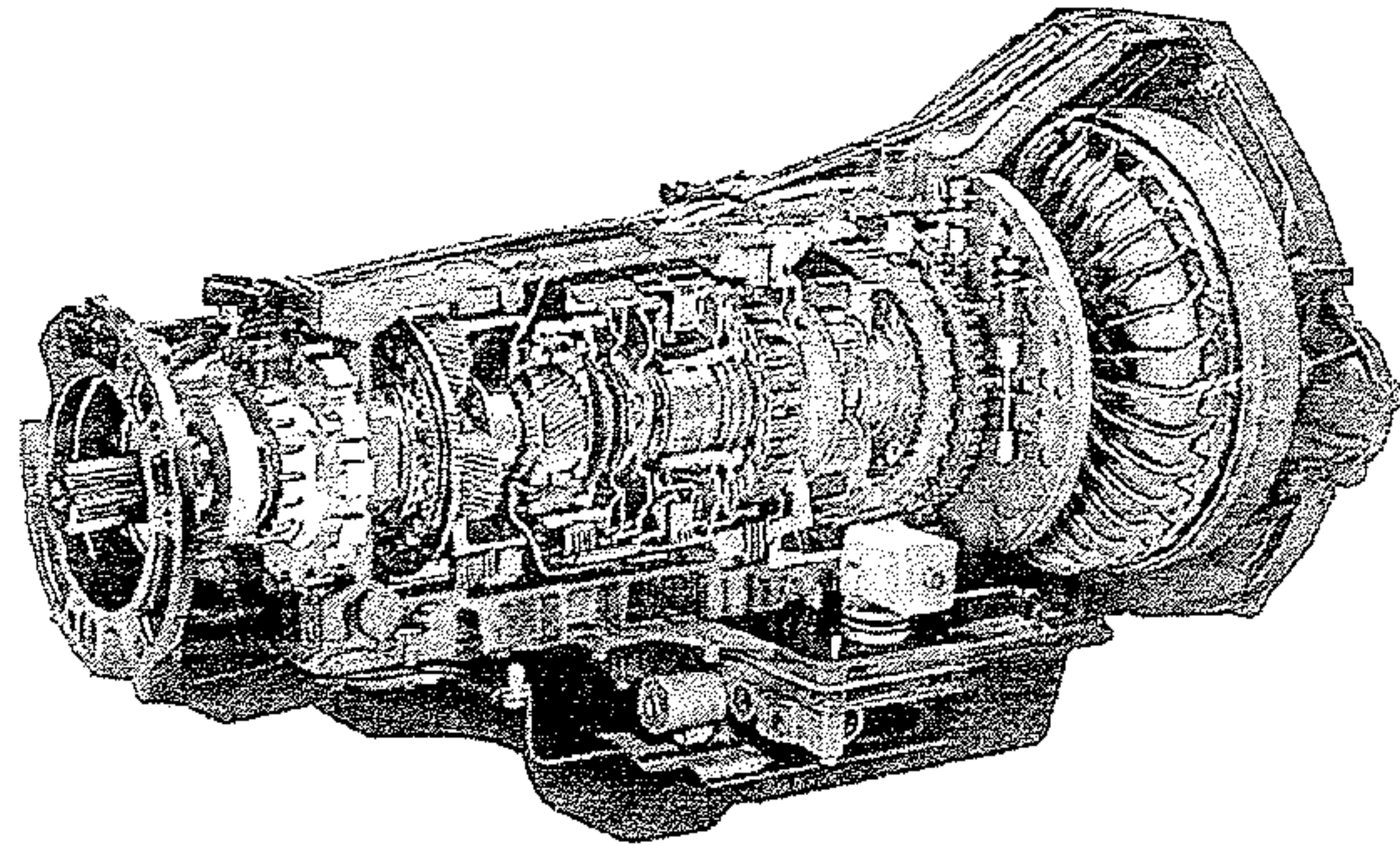

We proudly welcome all New Customers
 and Former Advanced Transmission
 Customers with a 10% Discount and Any
 Transmission Service or Repair*

865-986-9359

865-986-5050

Bad Credit, No Credit OK!!! We Finance Everybody!!!

Taxes Done Here!!! Bring your last pay stub or W2 and DRIVE TODAY!!!

Over 100 Cars, Trucks & Vans in Stock - Warranties On ALL Vehicles Sold!!!



2007 Chevrolet Uplander,
 60k miles, NICE!!!

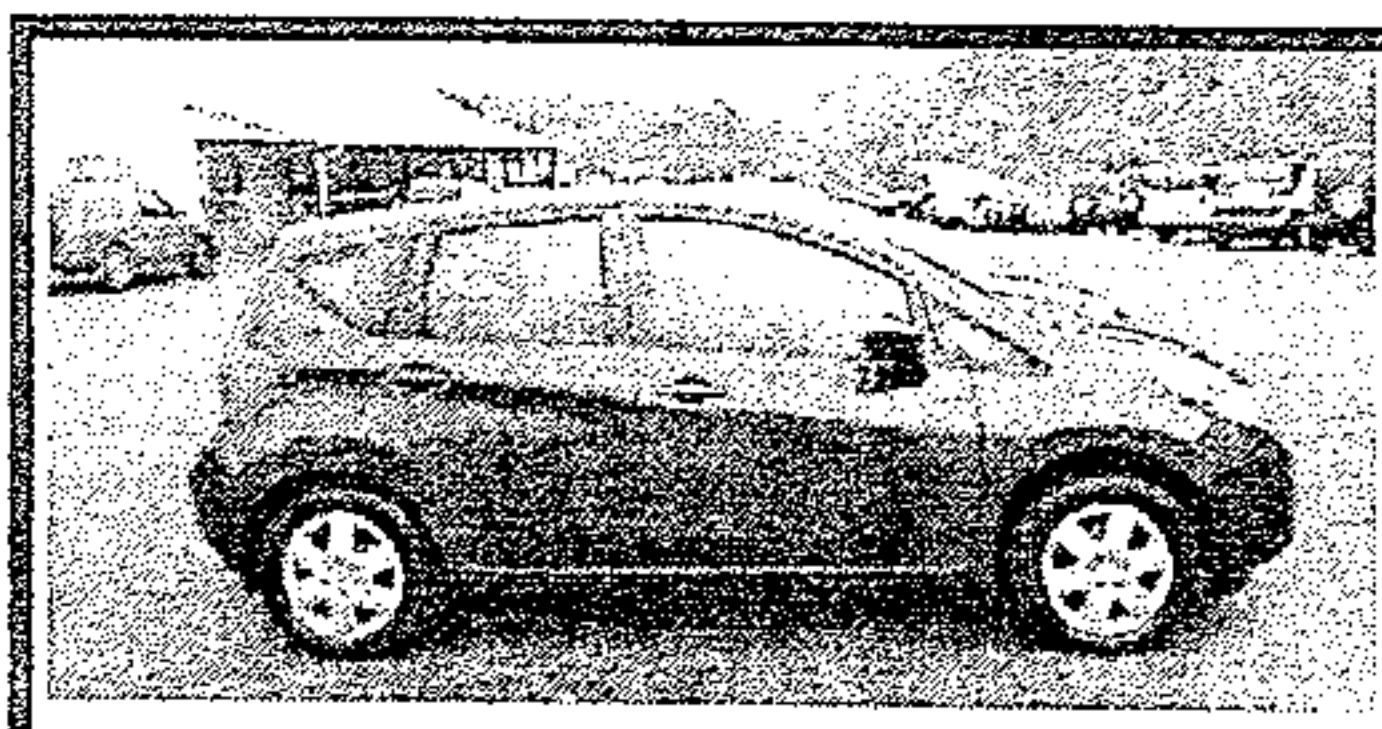

2015 Nissan Versa Note, Fac-
 tory Warranty, Low Miles

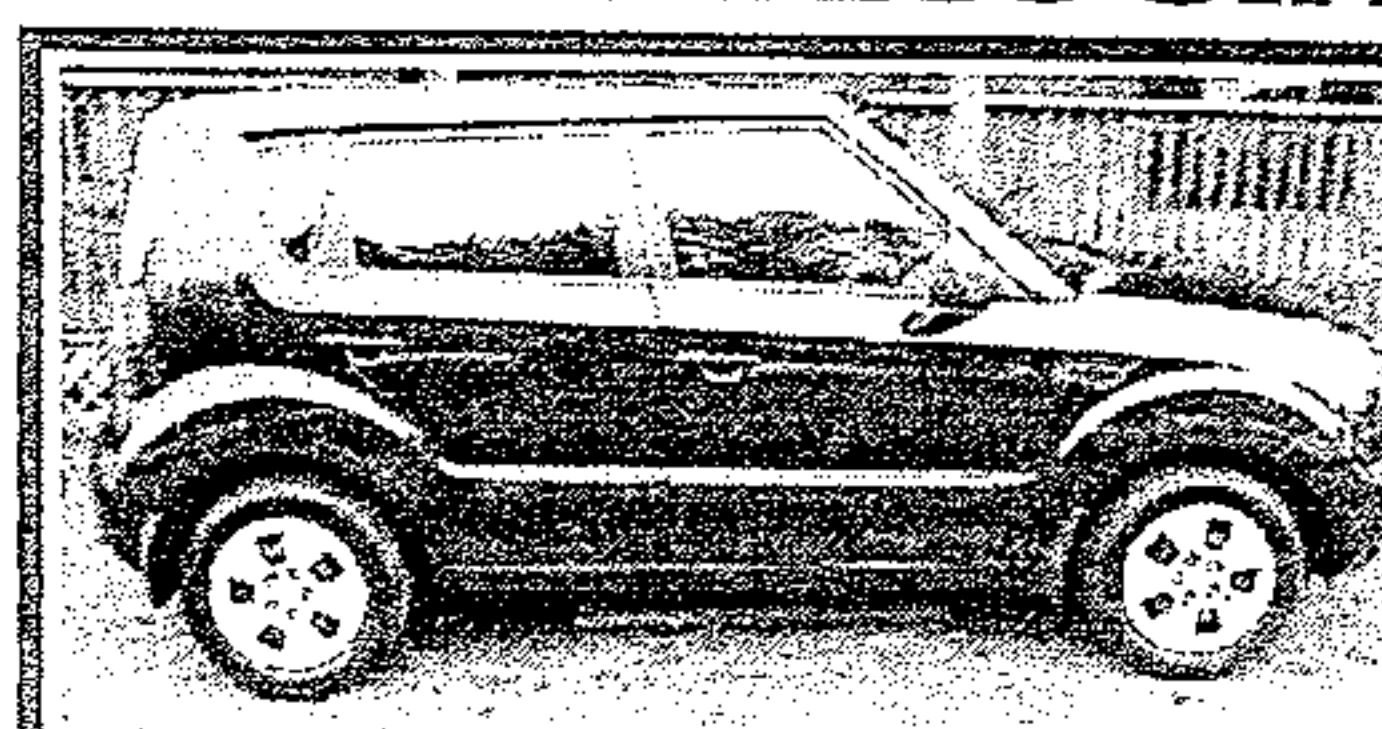

2011 Kia Soul, 5 speed, 4 dr,
 Gas Saver, Nice & Clean



2008 Saturn VUE, LOADED!!!
 4dr, Ready to go on a trip!

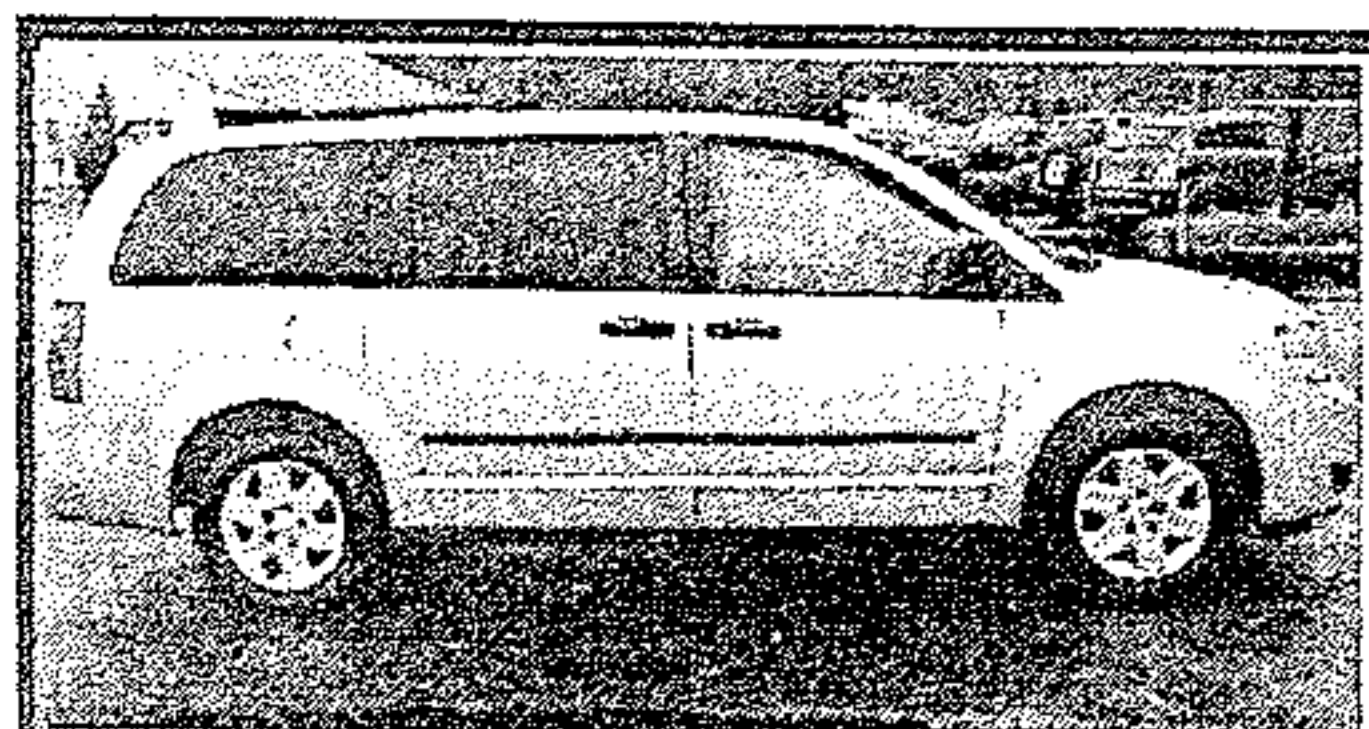

2008 Dodge Grand Caravan,
 Nice, Clean, Stow n Go!

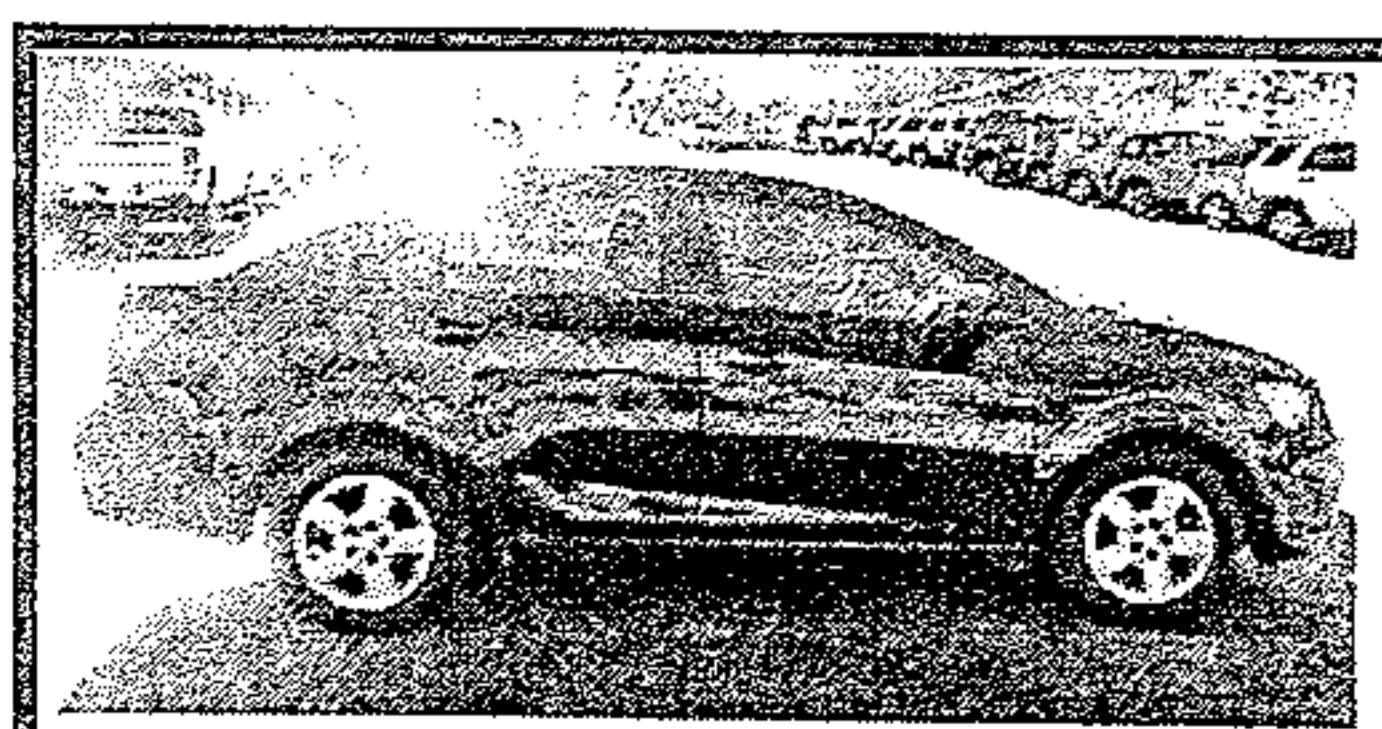

2014 Chevy Sonic, Factory
 Warranty, Low Miles!



Mitsubishi Raider, Ext. Cab,
 Super Nice Truck

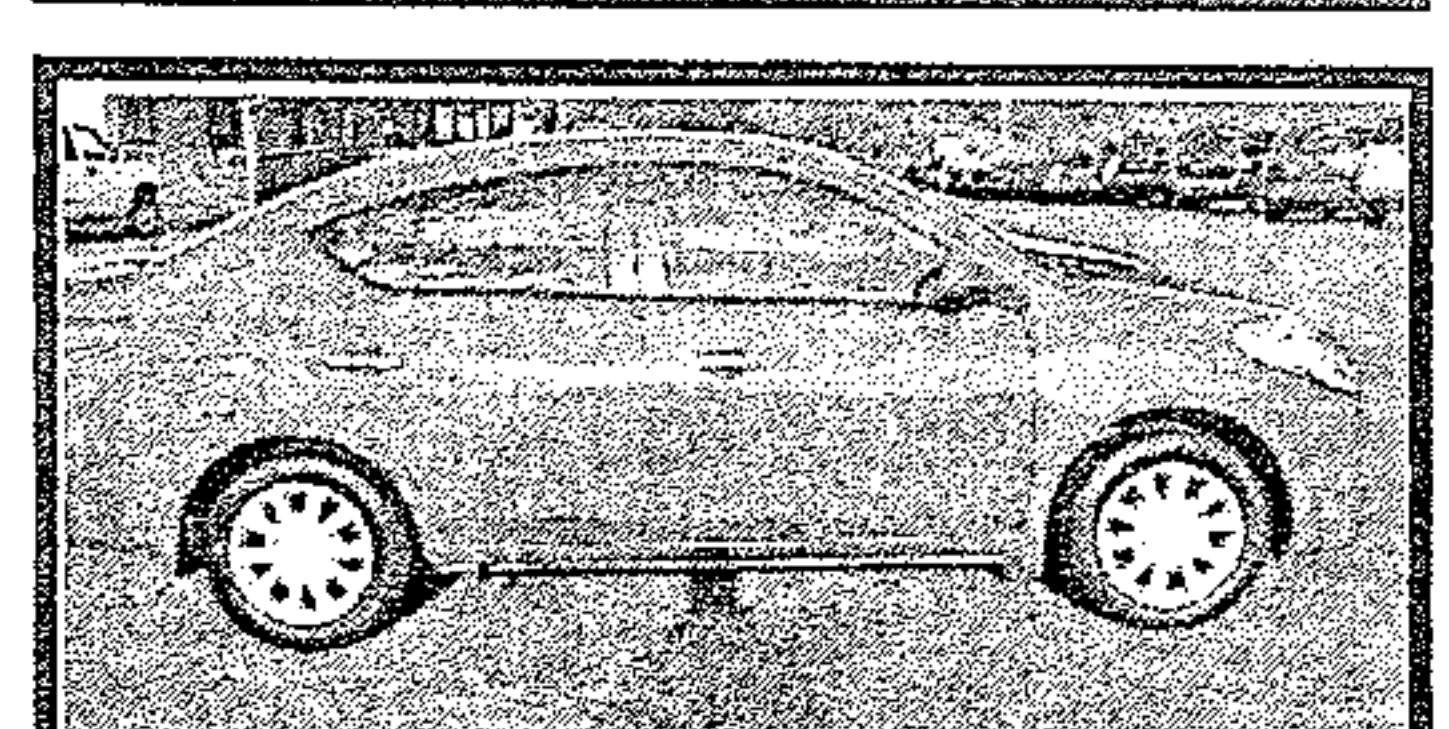

2013 Nissan Versa, Like New!
 LOADED!!!

WALT WILLIAMS, INC.

*with approved credit

3003 Highway 11 Lenoir City, TN **865-986-1111**