

The Daily Edition

50¢

Serving Loudon, Monroe and Surrounding Counties

Friday, March 11, 2016

THP charges 2 at wreck scene; drugs found

No charity for a meth user named Charity

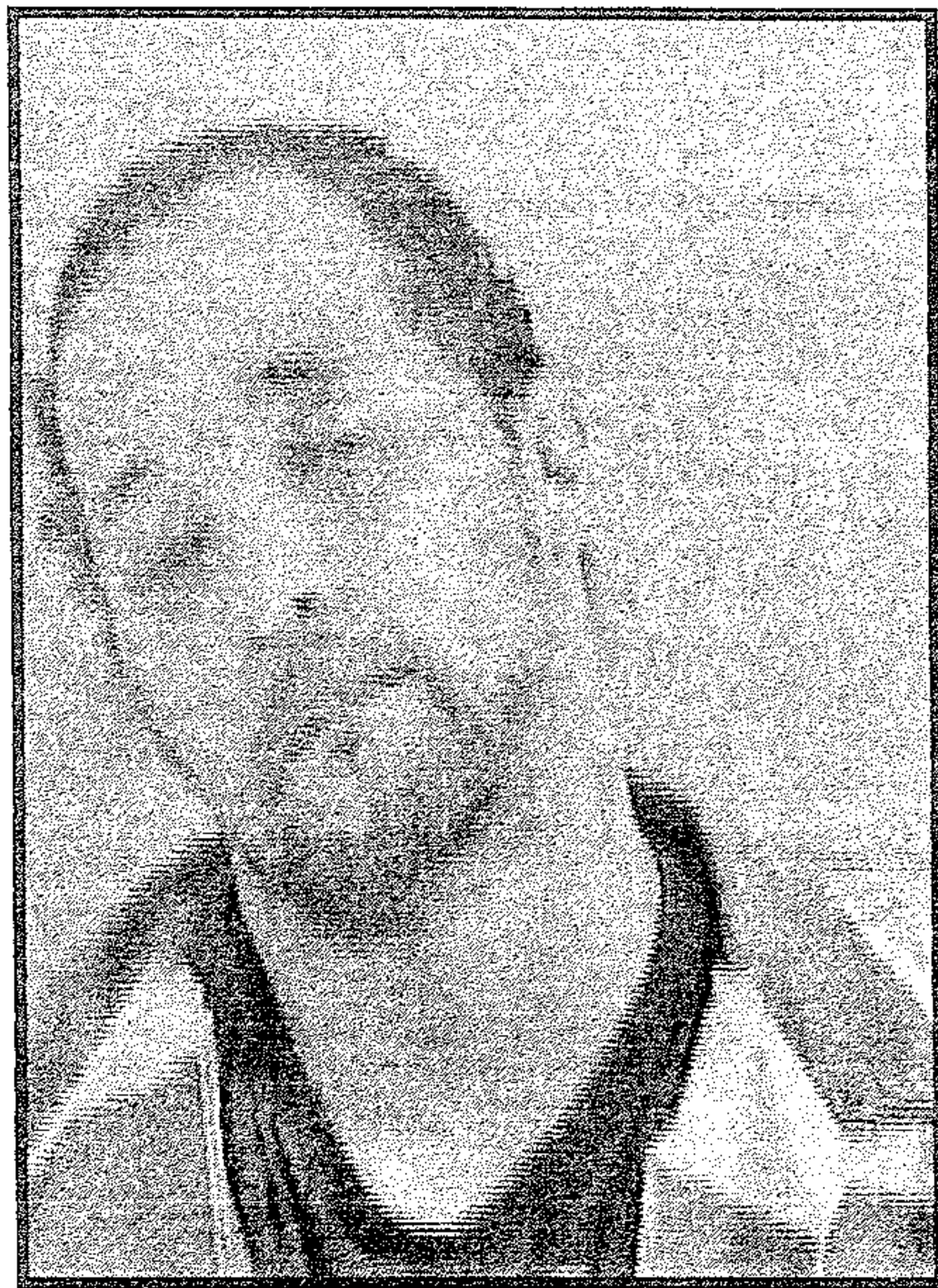

Joshua Tillman

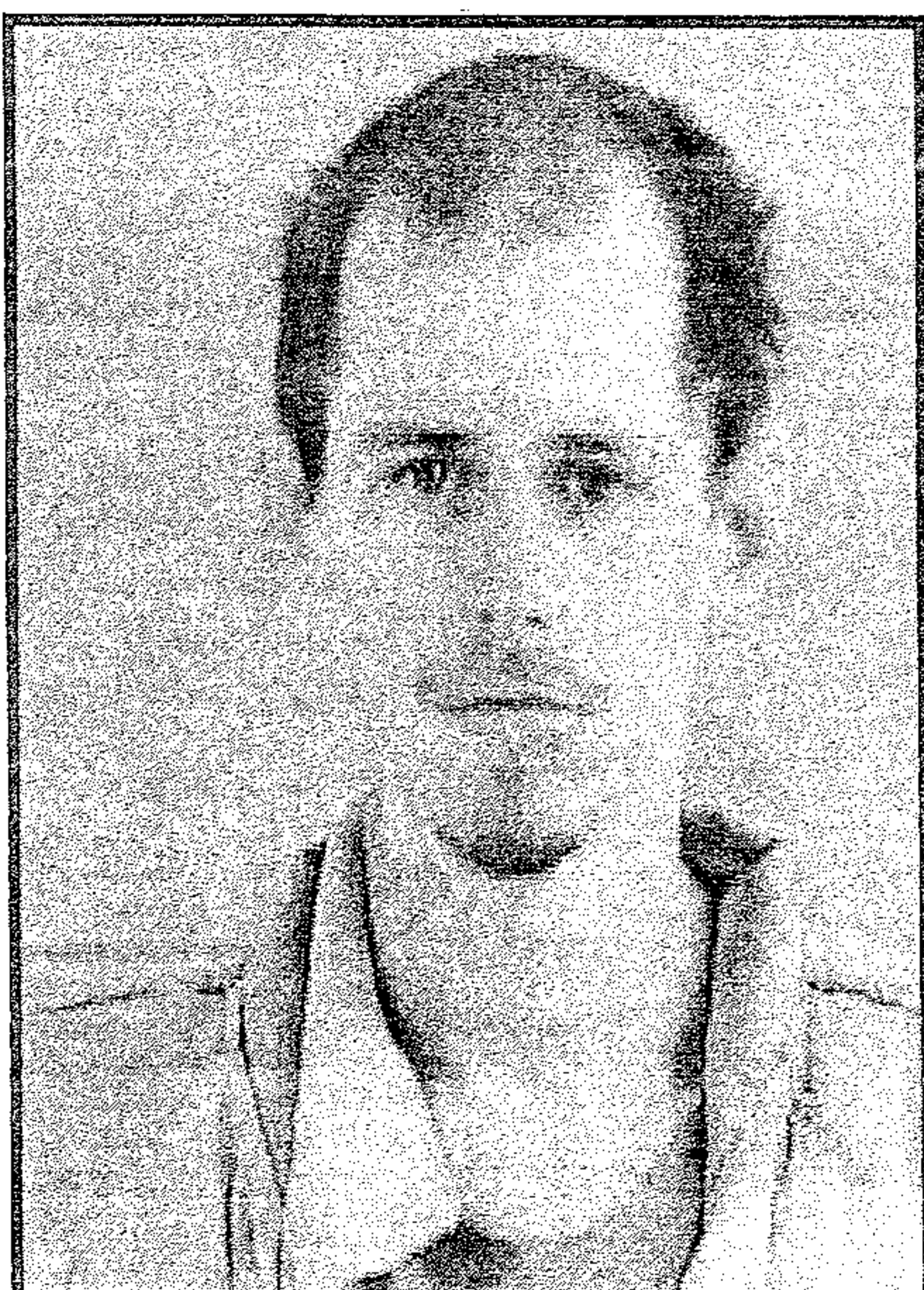

Wilford Gartin (see THP pg. 2)



Charity Wampler (see meth pg. 5)

Stopped for driving below the speed limit



Rebekah Rogers (see DUI pg. 3)

Fayette County Audit Includes Multiple Uncorrected Problems

An audit released today by the Tennessee Comptroller's Office identifies 14 areas of concern with the way Fayette County is being run.

The findings in the fiscal year 2015 report are spread across several county offices. Six of the findings were also noted in last year's report, but had not been sufficiently

(see audit pg. 7)

GOODSHEPHERD CENTER DINNER AND AUCTION

The Good Shepherd Center of Monroe County will hold its annual fund raising Dinner and Auction on April 2, 2016.

The location will be at the Tellico West Conference Center, 121 Grand Vista, Vonore TN 37885.

The silent auction will begin at 5:30 PM and the catered dinner will be at 6:30 PM.

(see GS pg. 5)

Verse of the Day

What shall we conclude then? Are we any better? Not at all! We have already made the charge that Jews and Gentiles alike are all under sin. As it is written: "There is no one righteous, not even

one ..." — Romans 3:9-10

Obituaries

see inside
Wazzup

It's flu season for sure it seems everybody is getting it and reportedly the doctors offices

are giving nothing!

Weather

Today: Scattered thunderstorms, especially in the afternoon. High 71F. Tonight: Showers in the evening, then cloudy overnight. Thunder possible. Low 56F.

Saturday Mostly cloudy skies. Slight chance of a rain shower. High 79F. Saturday Night Considerable cloudiness with occasional rain showers. Thunder possible. Low 59F.

(Continued on page 6)

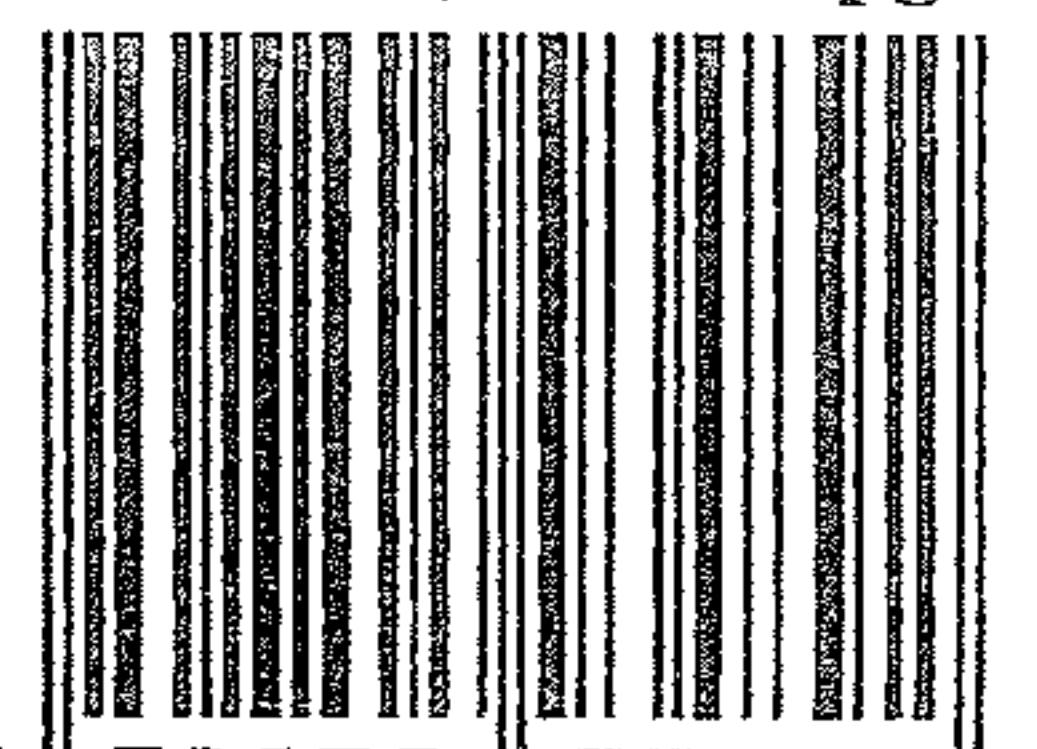

3 08805 93489 2

THP

Wilford Gartin, 27, Chapman Hwy Seymour, was charged with DUI, Simple possession, Driving on Revoked License, and Contraband in a Penal Institution.

Joshua Tillman, 37, Washington Ave Athens, was charged with DUI by Consent, and Poss. of Meth.

Trooper Smith THP, was dispatched to a single vehicle accident on -75 at the 81 mm. Upon arrival Trooper observed that the vehicle had ran off the roadway and had not applied any brakes and traveled in excess of a 100 yards off the interstate and came to a final rest in a tree line. Both the driver Wilford Gartin, and passenger Joseph

(see THP ctd. pg. 4)

Call 865-771-2249 to Advertise and start saving today!
Has your group got an event coming up?
Let us know!!!

To Get a Burning Permit:

Loudon (865) 986-8395
 Monroe (423) 442-7401
 Roane (865) 354-1054

Notice: The Daily Edition does not knowingly accept fraudulent or misleading materials. The Daily Edition cannot guarantee the validity of offerings or statements contained herein. All liability for the contents of all advertising, and for any claims that may arise therefrom, is the responsibility of the advertiser or its agency. The Daily Edition reserves the right to reject, edit, or abbreviate any advertisement submitted. Advertising is accepted with the understanding that all liability for all copyright violations is the sole responsibility of the advertiser.

Photographs, artwork and other copy submitted for publication is considered the sole property of the advertiser. The Daily Edition will make every effort but will not be liable for failure to publish and ad or for typographical and layout errors. All statements and information about highlights featured items, letters to the editor, herein are those solely given to the interviewer or writer and the Daily Edition assumes no responsibility of the accuracy or validity thereof. The Daily Edition will gladly reprint at no charge that part of an advertisement in which an error occurs provided a claim is made within 3 days of the first publication of the ad. Information contained in the Wazzup is received anonymously and the Daily Edition assumes no responsibility for information and reserves the right to edit or reject any and/or all submissions. The Daily Edition is a daily newspaper of general circulation in Loudon County defined under TCA 2-1-104(a)(13).

The Daily Edition also serves Monroe, Knox, Anderson, Roane and Blount counties and serves 30,000 readers weekly. Send mail to PO Box 1240, Lenoir City TN 37771. 865-771-2249. email: dan1204us@yahoo.com

The Daily Edition is Loudon County's premier public interest and paid advertising paper. The Daily Edition is produced and published daily Monday through Friday and is circulated throughout Loudon County and parts of Monroe and Knox Counties. Display advertising rates \$5.00 per column inch and quantity discounts available. Call for information on upcoming promotions and events.

HACIENDA Ayala's
Mexican Restaurant
 Market Dr. * Lenoir City (In Front of Food City)

Real Authentic Mexican Food at Affordable Prices

BEST MARGARITA

You've Tried The Rest
 Now Come Have The Best!!!

We Accept ALL Competitors Coupons Outside of Mexico City!

986-3553



Good Credit OK • Bad Credit OK • Bankruptcies OK • Repo OK



2010 Kia Soul Sporty, 4 cyl, Auto, PW, PL, A/C, Great On Gas, Like New



2010 Ford Escape Limited Leather, Alloy Wheels, Heat, A/C, Luggage Rack, 79K,



2007 Dodge Ram 1500 Quad Cab, Thunder Road PKG, 20 in. Wheels, Low Miles, Hemi



2008 Ford Explorer 84k, 3rd Row Seating, Luggage Rack, Tow Pkg, PW, PL



2011 Ford Ranger Low Miles, Tow Pkg, New Tires, A/C, Heat, Bed Liner.



2011 Dodge Grand Caravan DVD, Stow & Go, Loaded, Remote Doors, Rear A/C

DEPENDABLE MOTORS 986-9343
803 E. Broadway • Lenoir City

Serving Loudon County for 20 Years

* WAC. See Dealer for details

Visit our website at: www.dependablemotorslc.com

DUI

Rebekah Elinor Rogers, 22, of Jacobs Crossing Drive, Crossville, was charged with driving under the influence.

Officer Akins LPD, observed a vehicle coming towards his direction on Hwy

72 with there bright lights on and never deemed them. Officer got behind the vehicle and followed it about a mile and a half. On his observation, he witnessed the vehicle doing fifteen MPH under the posted speed limit, which is a forty five MPH zone. Officer witnessed the vehicle swerving from the yellow line to the white line, several times. Officer conducted a vehicle stop, and identified the driver as Ms. Rebekah Rogers. After making contact, Officer noticed that Ms. Rogers had blood shot watery eyes and a strong odor of an alcoholic

beverage arising from her person. Officer advised her the reason of the stop and asked her if she had been drinking. Ms. Rogers advised, that she

drunk a couple glasses of wine, approximately three glasses, prior to stopping her. Officer asked Ms. Rog-

(see DUI ctd. pg. 5)

For Sale: Oak Wood Mulch



Mushroom Compost Topsoil.



Firewood

Call Steve Spoon
986-4282

The Daily Edition
serving Loudon and surrounding counties since 1986

C&C Lawn Care
Mowing, Mulching, Trimming, Edging, Clear Debris
Free Estimates
Call Chad 865-271-8070

West End Storage & Warehouses
502 Ward Avenue • Loudon
Call 865-458-4774 or 865-679-5555

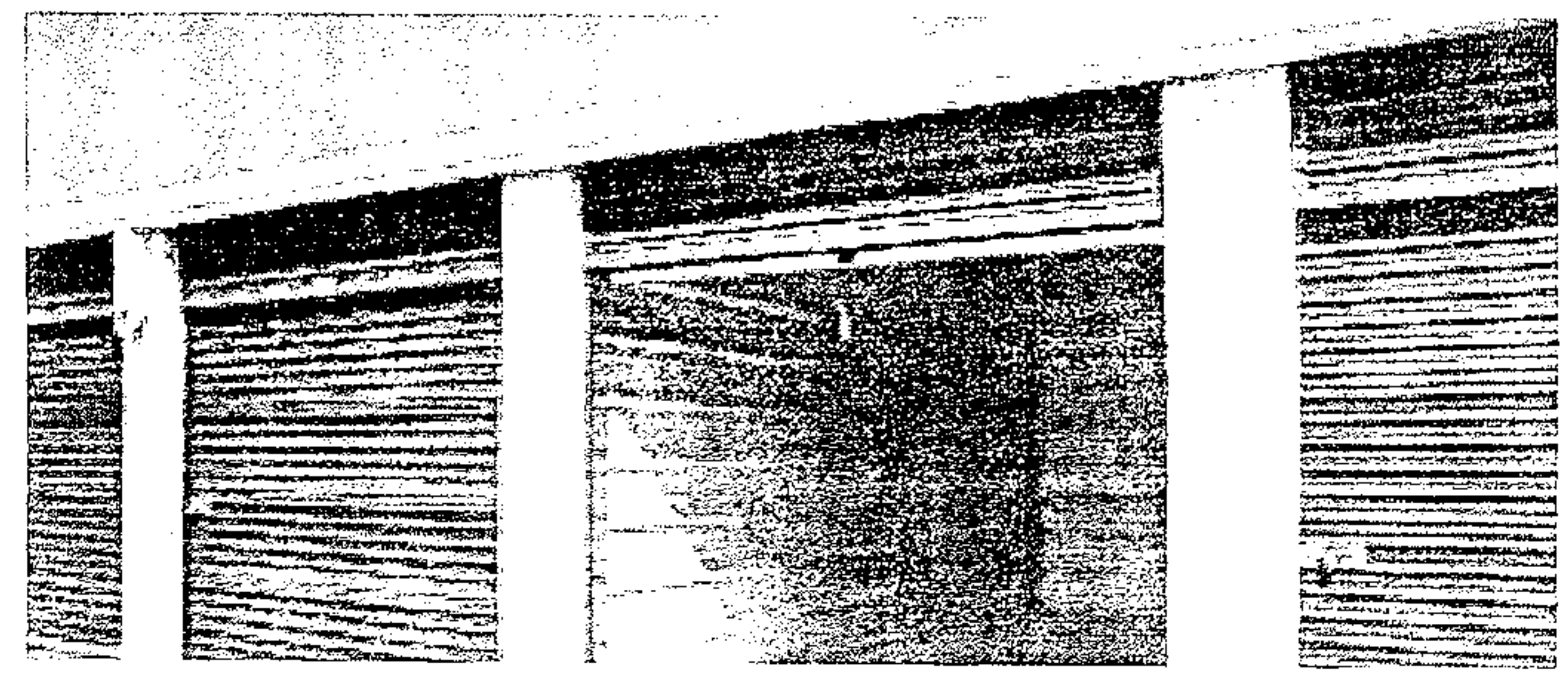

STAINED INK
TATTOO & PIERCING
LENOIR CITY 865 816-6440
NEW OWNER • NEW ARTIST • SINCE 2011
521 Hwy 321 next to Vape & Stuff & Inn Of Lenoir!
Clean-Affordable-Quality-Custom
Tattoo's You've Always Wanted!

BRING IN THIS AD FOR **\$25 OFF**
NEW INK FOR NEW CUSTOMERS ONLY!

Check us out on FB.com/
Stained.Inc.Tattoo/
www.STAINEDINC.com

C&J Towing and Recovery
LOWEST TOWING RATES AROUND!!!

Have you been overcharged for any type of towing service in the Lenoir City area? If you have a breakdown or accident please OWNER REQUEST C&J Towing with the officer. Also please call your Sheriff and ask him to place C&J Towing on the "Rotation List*" and help other motorists save as much as you did! We at C&J are locally owned and operated, State approved, licensed, bonded and insured. Call and let us know if your denied service or how we can be of assistance.

*note: the "Rotation List" is a list of wrecker services that provide service for wrecks, DUI's, breakdowns, etc. and are on an on-call basis for service. This list is approved by the Sheriff.

Cliff Teeters • Owner
865-809-1661

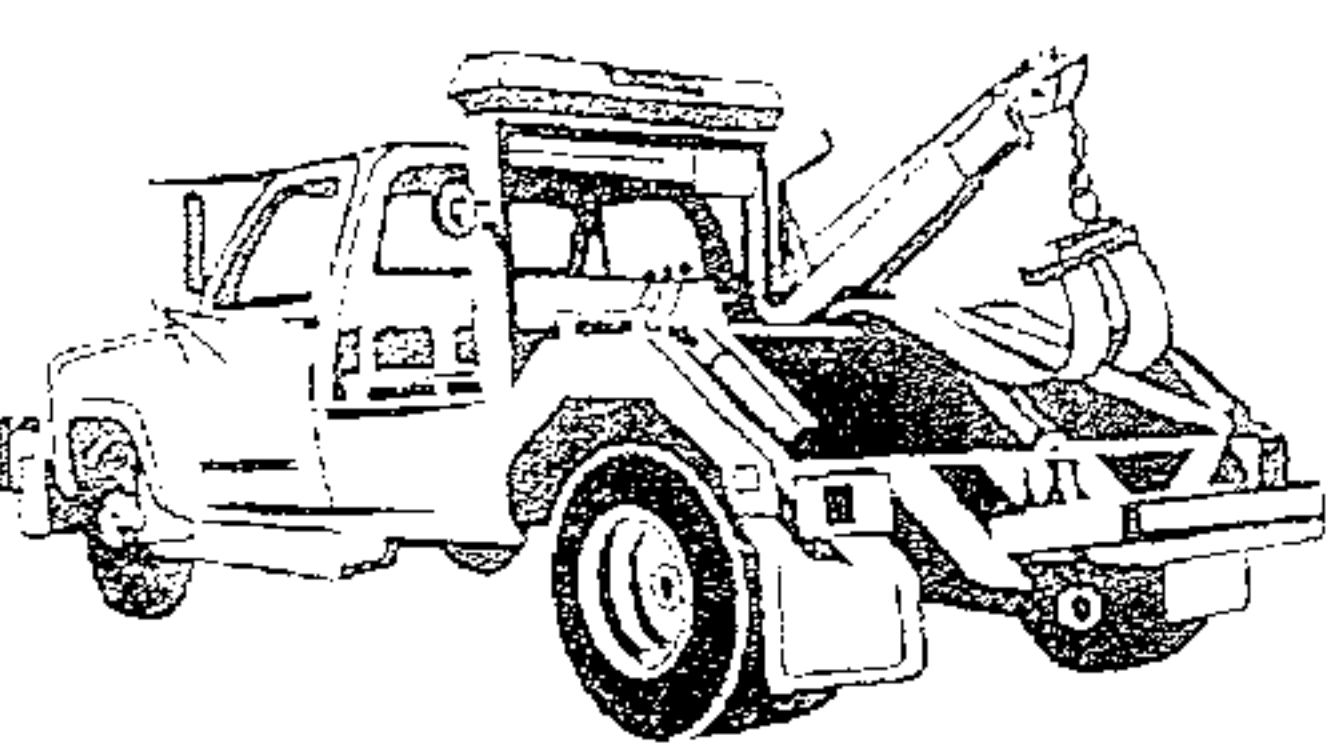

BIMBO'S
Deli Open 24 Hours
865-986-9643 Call Ins Welcome

Specials

Lg. Cold Sub, bag of chips and 16 oz. fountain drink
only \$6.29

Footlong Corn Dog \$2.59

THP ctd. from pg. 2

Tillman, both refused medical treatment. Upon speaking with the driver Wilford Trooper noticed his speech was slurred, eyes were bloodshot, pupils were constricted and having body tremors. Trooper ask Wilford if he had taken any medication he stated no that he had used marijuana and methamphetamines the night prior. Wil-

ford failed all sobriety test. Wilford license were revoked. Wilford was placed under arrest and ask if he had anything else on him he stated no. Joseph Tillman id the owner of the vehicle and allowed Wilford to drive while he was under the influence, Joseph was charged with DUI by Consent he also had meth in his possession. While Wilford was be-

(see THP ctd. pg. 5)

Help Wanted

**Experienced
Dispatcher
Needed At
Moneymaker
Wrecker Service**
Apply in person
at 11776 Hwy
70, Lenoir City

BUDGET Transmissions

302 S. Northshore Drive Knoxville

(865) 584-4391 budget-transmissions.com

Why Buy From Budget?

Free Towing From Lenoir City
or Loudon County

20 Years of BBB Zero Customer
Complaints Award Member
A+ Plus Rated

Huge Transmission Inventory

Best Technicians Period!!!

Call (865) 584-4391 Today!

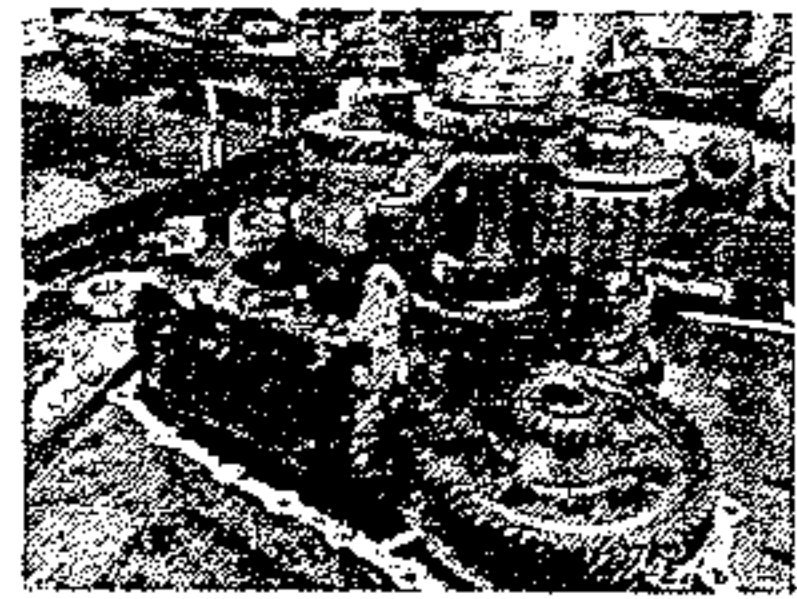

NEED HELP WITH INCOME TAX? PROFESSIONAL TAX SERVICE

PRICE - 95% of returns between \$60-\$140

(No Coupons Required)

LOCALLY Owned & Operated - Open Year Round

30+ Years in the business

ALL Preparers with 10+ years experience

Pro Tax

111 E. Broadway

Lenoir City, TN 37771

Phone 865-986-4035

*US Armed Service Active Duty Personnel, "THANK YOU", Tax Return Free

good
to know
you™

IMMEDIATE OPENINGS!

Randstad is NOW HIRING for 2nd shift Assembly Positions at Commercial Vehicle Group. These are long-term, temp-to-hire positions!

Hours: 4:30pm - 3:30am (end times vary)

Pay: \$10/\$10.50 per hour

You may apply by visiting our Facebook page www.facebook.com/vonorejob and clicking the "Sign Up" button. You can also get a paper application from the Guard Shack at 200 National Drive, Vonore, TN 37885.

For questions, call 423.884.4733

www.randstadstaffing.com

EOE

randstad

Staffing | Professionals | Search & Placement | HR Solutions | Inhouse Services

meth

Charity Wampler, 36, Big Sandy Road Philadelphia, was charged with Simple Possession, Theft of Property, and Poss. of Drug Para. Deputy Cody Fritts LCSO, observed a blue vehicle parked at the back of the Dollar Store in Philadelphia. A female appeared to be stealing boxes and food crates.

Deputy identified the female as Charity Wampler. Deputy ask her if she had permission to take the items she stated no. It was confirmed through the store manager she did not have permission to take items. Deputy ask Charity if she had anything illegal on he she pulled a item from her right pocket and tried to stuff a baggie with white powder back in

her pocket. Deputy ask Charity to hand him the baggie, which she did. The baggie contained a small amount of Methamphetamine in it. A search of the vehicle revealed 4 hypodermic needles, a spoon, and a razor blade. The boxes and crates were returned to the store and Charity was placed under arrest. Deputy Cody Fritts LCSO, made the arrest.

DUI ctd. from pg. 3
 ers to exit the vehicle and ask her to perform Standardized Field Sobriety Test. As she exited the vehicle, he noticed she was unsteady on her feet. During the Sobriety test. She did poorly on the Horizontal Due to officer observation, he felt like Ms. Rogers was under the influence of alcohol and/or drugs. officer placed Ms. Rogers under arrest. She was

transported to Loudon Emergency Room, then transported to the Loudon County Jail. The above incident did occur in the City of Loudon. Officer Akins LPD, made the arrest

GS

Entertainment will be the dynamic singing duo known as Vocal Point.

Tickets are \$40 each, of which 20 dollars is income tax deductible. For those who wish to support the Good Shepherd but are unable to attend this function, there are Feed a Family tickets available, also \$40 each.

Tickets may be purchased at The Good Shepherd Center, The Monroe County Chamber of Commerce, the Kahite Club House and individual Good Shepherd volunteers.

The Good Shepherd Center is a 501©3 organization.

Some of the things The Good Shepherd Center provides are food to over 2,100 men, women and children every month, personal care items as requested, clothing to each person per household, miscellaneous items each month, transportation via ETHRA for medical appointments, emergency housing for fire victims, layette sets for newborn babies and utility vouchers.

The Good Shepherd Center is supported financially by churches, local businesses, and individuals. Additional funds are provided through grants, auxiliary groups, Monroe County governmental agencies and fundraising events such as this Dinner/Auction event.

THP ctd. from pg. 4

ing searched at the jail Deputy did find a marijuana blunt in his buttock. Trooper Smith THP, made the arrest.

PURDY'S AUTO PARTS AND SALVAGE

WE BUY SCRAP IRON • COPPER • BRASS • ALUMINUM

\$

Paying Top \$\$\$

Call For Latest Prices

You Name It, We Buy It!

Radiators, Wheels, Batteries, Appliances, Farm Equipment

Copper

Paying Top \$\$\$

Call For Latest Prices

You Call We Haul!

423-519-5402



* Prices subject to change with the market.

423 337-3977

149 County Road 323 Sweetwater

Complete Cars

per 100 lbs.

Scrap Metal

Paying Top \$\$\$

Call For Latest Prices

per 100 lb

We Buy Batteries

Aluminum Cans

Paying Top \$\$\$

Call For Latest Prices

**Now Selling
 Aftermarket
 Body Parts at
 Discount Prices**

* Prices subject to change with the market.

audit addressed by local officials.

For the third year in a row, at least two funds required material audit adjustments in order to correct year-end financial statements. Account balances in the General and General Debt Service funds required adjustments totaling \$525,505 and \$175,749, respectively. These adjustments are a strong indicator of a county's failure to maintain its accounting records.

Auditors also found multiple other problems that included county purchasing procedures, expenditures

exceeding appropriations, cash overdrafts, and unreconciled accounts.

Comptroller auditors have included recommendations to correct all 14 of the findings noted in the audit report.

"Fayette County leaders should work closely with its Audit Committee to address these ongoing issues," Comptroller Justin P. Wilson said. "It concerns me when I see the number of audit

findings growing from one year to the next. It's also troublesome when issues have gone uncorrected over several years."

To view the audit online, go to: <http://www.comptroller.tn.gov/la/>

If you suspect fraud, waste or abuse of public money in Tennessee, call the Comptroller's toll-free hotline at (800) 232-5454, or file a report online at: www.comptroller.tn.gov/hotline. Follow us on twitter: @TN-COT

Haslam Appoints Smith Circuit Court Judge for 30th District

Replacement for the late Judge D'Army Bailey

Tennessee Gov. Bill

Haslam today appointed Valerie L. Smith as circuit court judge for the 30th Judicial District, which serves Shelby County.

Smith's appointment fills the vacancy created last year by the death of Judge D'Army Bailey.

Smith, 40, has been an attorney at Nahon, Saharovich & Trotz in Memphis since 2006, where she has managed hundreds of cases and practiced extensively in court in Shelby County as well as circuit courts throughout the state, the Tennessee Claims Commission, bankruptcy court and federal court.

She served as assistant district attorney general in Shelby County from 2000-2006, where she worked on numerous jury and bench trials, managed various aspects of criminal prosecution

and worked on special assignments including narcotics prosecution and the anti-gang unit. Smith was a clerk for Shelby County Circuit Court Judge James F. Russell from 1999-2000.

"We're fortunate to have someone with Valerie Smith's experience to bring to the bench in the 30th District," Haslam said. "Her service in the Shelby County District Attorney General's office and her years of work in private practice have prepared her to serve the people of the 30th Judicial District well."

"I am deeply humbled and thank Governor Haslam for this appointment," Smith said. "I am honored and grateful for this opportunity to serve the citizens of Shelby

see Judge ctd. pg. 8

Help Wanted

Position Available Immediately! Apply in person at the Kenjo Marathon on Hwy 321 in Lenoir City.

LOOK! \$75 Weekly Payments LOOK!

MARTY'S AUTO SALES • 986-2222 • MARTY'S AUTO SALES • 986-2222 • MARTY'S AUTO SALES • 986-2222 • MARTY'S AUTO SALES • 986-2222 • MARTY'S AUTO SALES • 986-2222

- Bad Credit
- Divorce
- Fixed Income
- Repos
- Bankruptcy
- No Credit



APPROVED!

Visit Us On The Web At: martysautosales.net

NO CREDIT CHECKS

\$99 down*

97 Escort, auto, gas saver
Only \$99 down *

\$299 down*

03 Taurus, runs good, Only
\$299 down *

\$199 down*

99 Venture, 7 passenger,
Only \$199 down *

\$499 down*

01 Sebring 2dr. sporty, Only
\$499 down *

\$599 down*

05 Trailblazer, auto, good
miles Only \$599 down *

\$499 down*

04 Aveo, auto, gas saver,
Only \$499 down *

\$799 down*

06 Tiburon GT, 5 speed,
sporty, Only \$799 down *

\$99 down*

98 Bonneville, 6 cyl, Auto, low
payments only \$99 down *

NO Credit Checks

Marty's Auto Sales
986-2222

Se Habla Espanol

100% Approval*

*See Dealer for details. All down payments plus tax, tag, title and fees.

MARTY'S AUTO SALES • 986-2222 • MARTY'S AUTO SALES • 986-2222 • MARTY'S AUTO SALES • 986-2222 • MARTY'S AUTO SALES • 986-2222 • MARTY'S AUTO SALES • 986-2222

Judge ctd. from pg. 7

County as a circuit court judge."

Smith received her law degree from the University of Memphis in 2000 after receiving a bachelor's degree in business administration from the University of Memphis in 1997.

She has been involved

in numerous community activities, including membership in the Junior League of Memphis since 2002 and the Mid-Town Memphis Rotary Club since 2011. Smith served as a board member for Mid-South Spay Neuter Services from 2012-2015 and for the Rotary Club from 2012-2014.

THE RELIC SHOP

521 Hwy 321 Lenoir City Suite 3
next to Stained Inc and the Inn of Lenoir
865-250-9280

HUGE NEW SELECTION OF FOSSILS, ARTIFACTS,
COINS, AND MORE

ALL AMETHYST 40% OFF

GREAT SELECTION OF ANCIENT MEGALODON
SHARK TOOTH OVER 8 MILLION YEARS OLD

Is Your Washer Broken?

Call Me

I Only Charge \$100 Period!!!

Call Allen

865-617-7113

A Name You Already Know And Trust Just Got Even More Dependable
DEPENDABLE AUTO SERVICE, LUBE AND TIRES
is Now Offering
Expert, Affordable Transmission Service

All ASE Certified Technicians

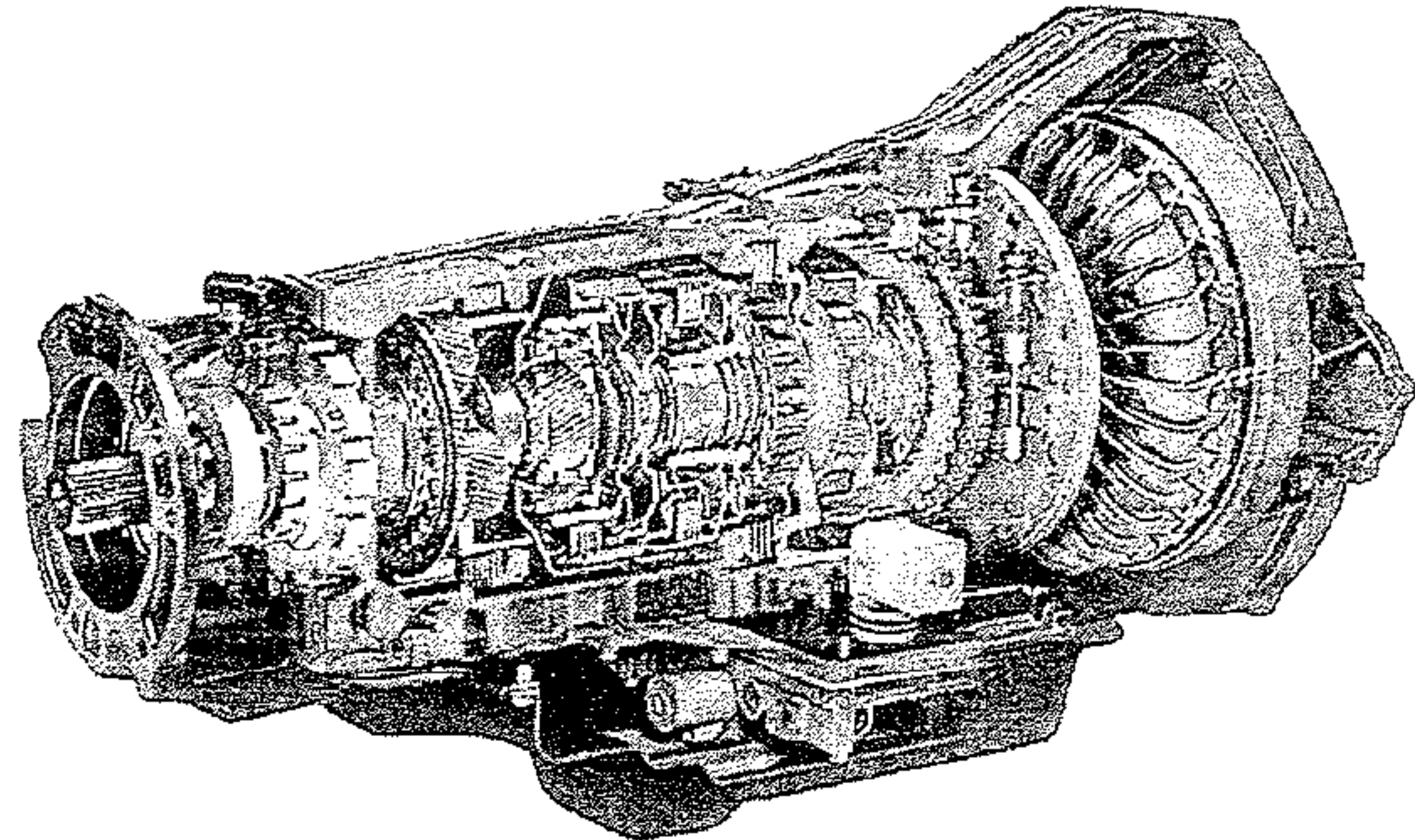

We proudly welcome all New Customers
and Former Advanced Transmission
Customers with a 10% Discount and Any
Transmission Service or Repair*

865-986-9359

865-986-5050

Bad Credit, No Credit OK!!! We Finance Everybody!!!

Taxes Done Here!!! Bring your last pay stub or W2 and DRIVE TODAY!!!

Over 100 Cars, Trucks & Vans in Stock - Warranties On ALL Vehicles Sold!!!



2007 Chevrolet Uplander,
60k miles, NICE!!!

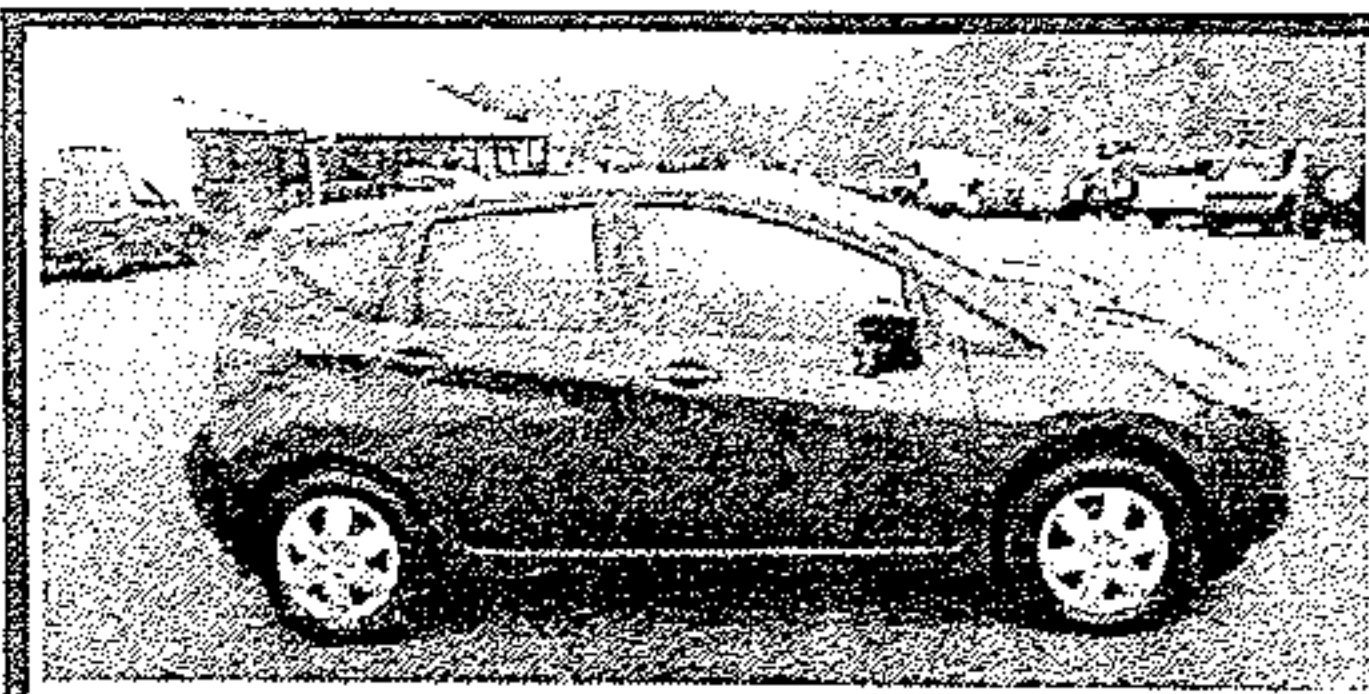

2015 Nissan Versa Note, Fac-
tory Warranty, Low Miles

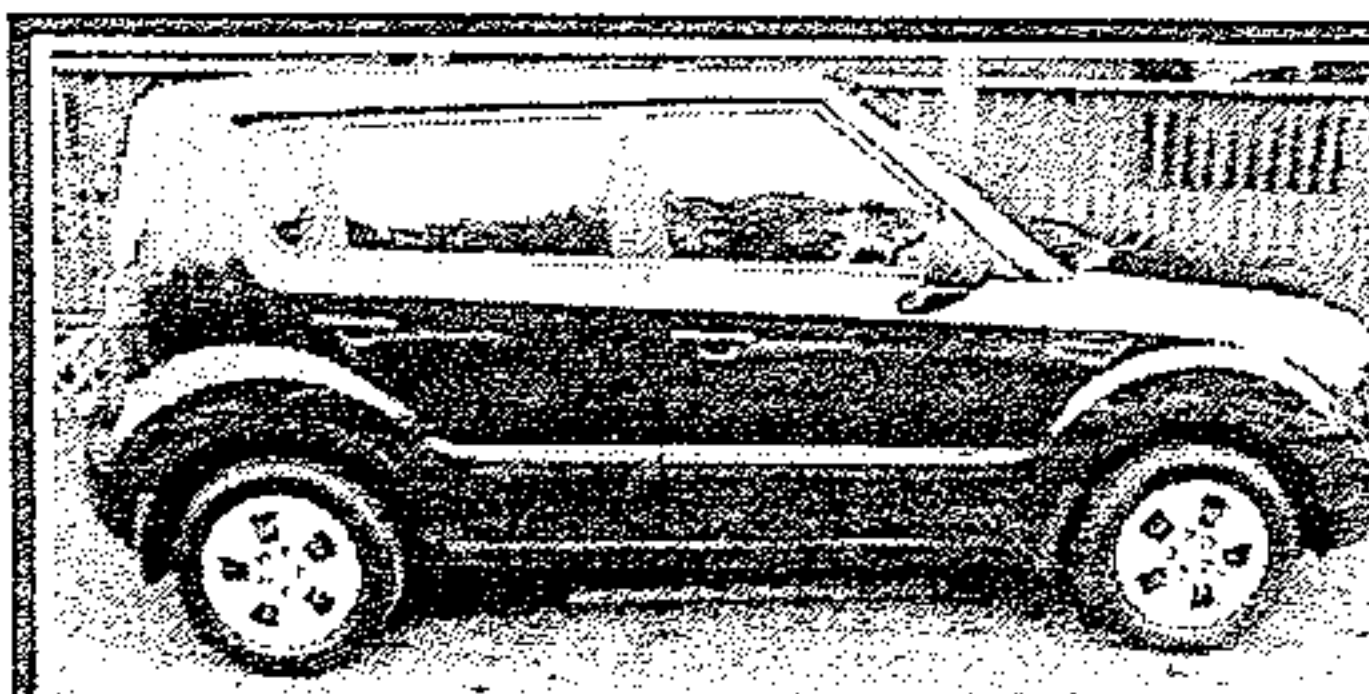

2011 Kia Soul, 5 speed, 4 dr,
Gas Saver, Nice & Clean



2008 Saturn VUE, LOADED!!!
4dr, Ready to go on a trip!

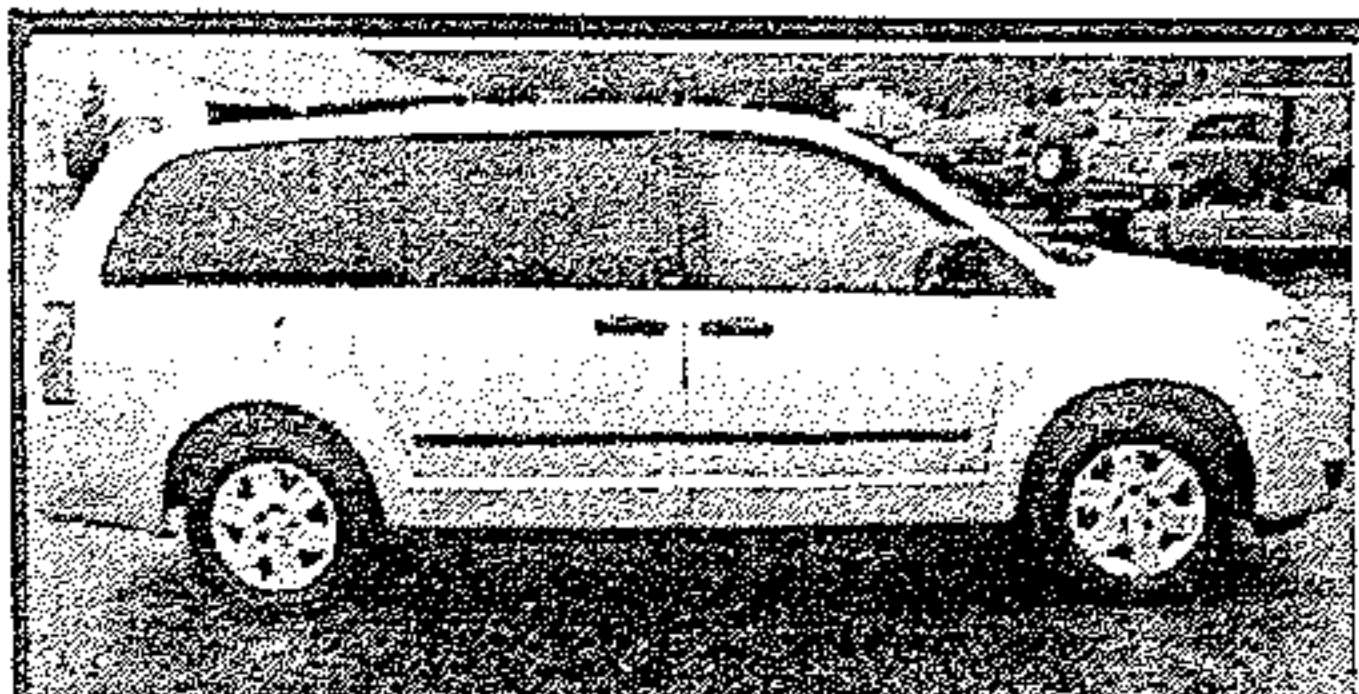

2008 Dodge Grand Caravan,
Nice, Clean, Stow n Go!

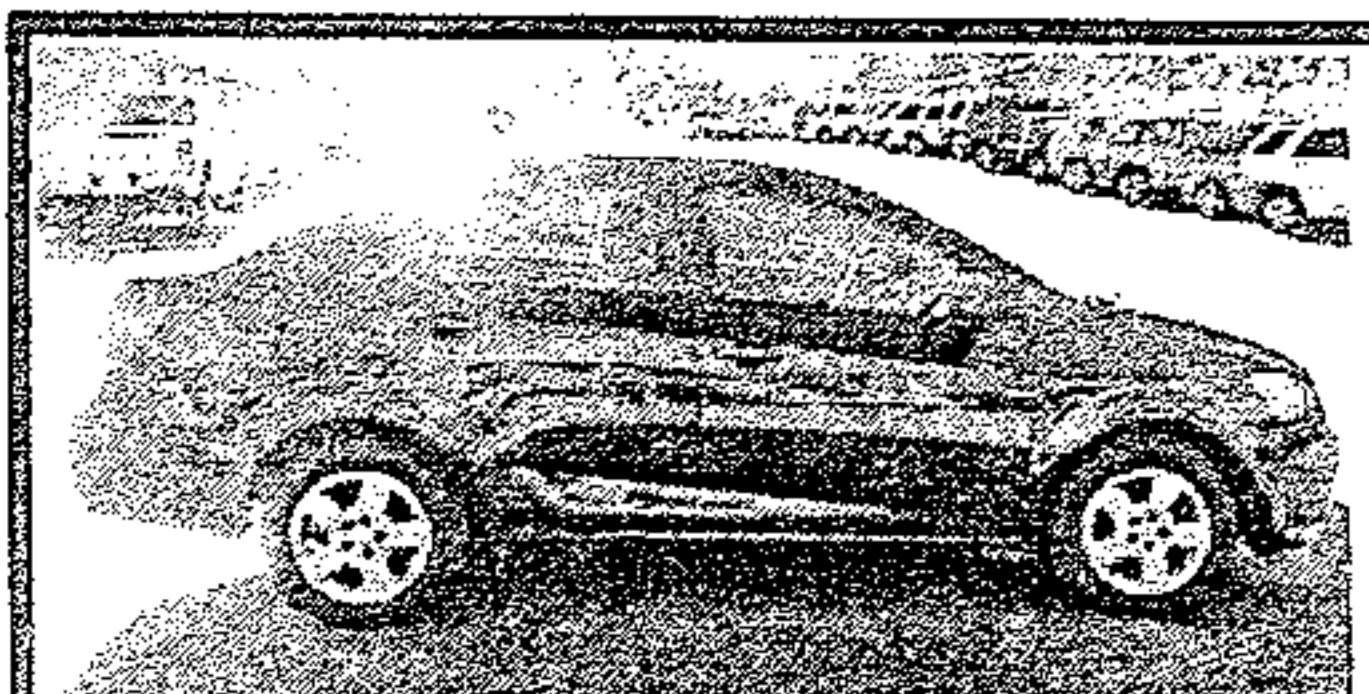

2014 Chevy Sonic, Factory
Warranty, Low Miles!

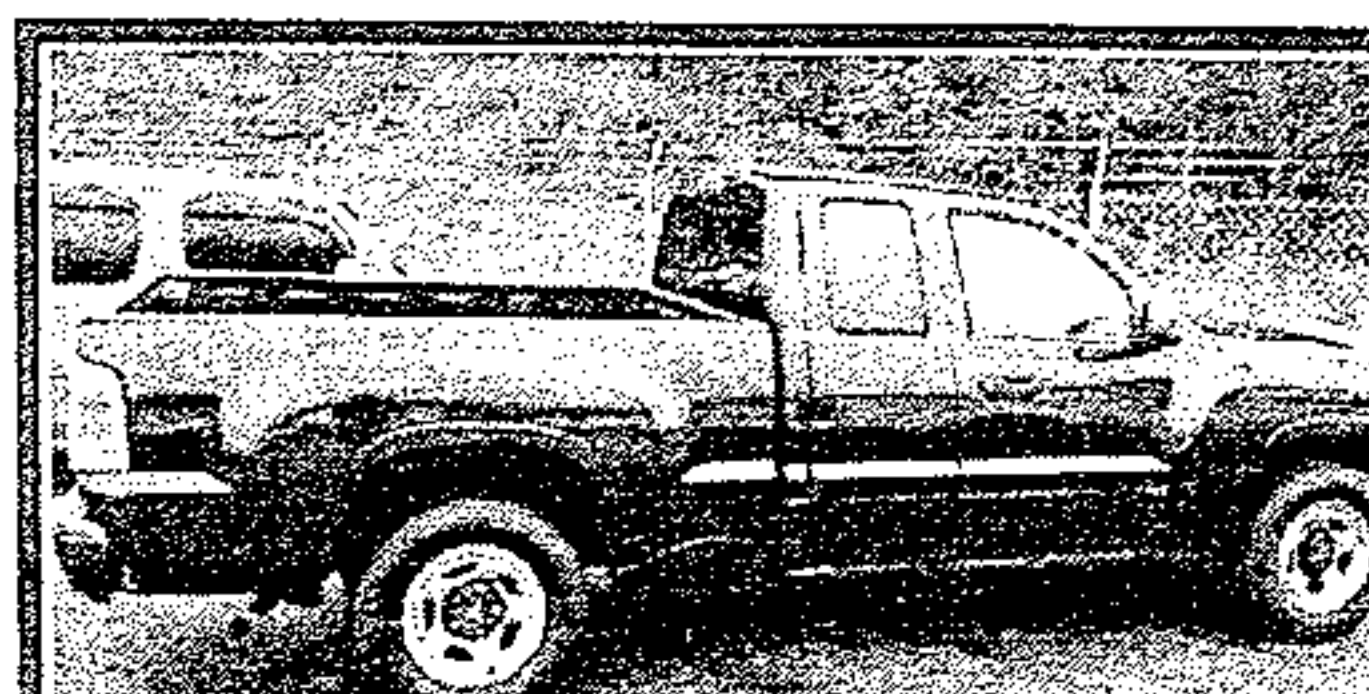

Mitsubishi Raider, Ext. Cab,
Super Nice Truck

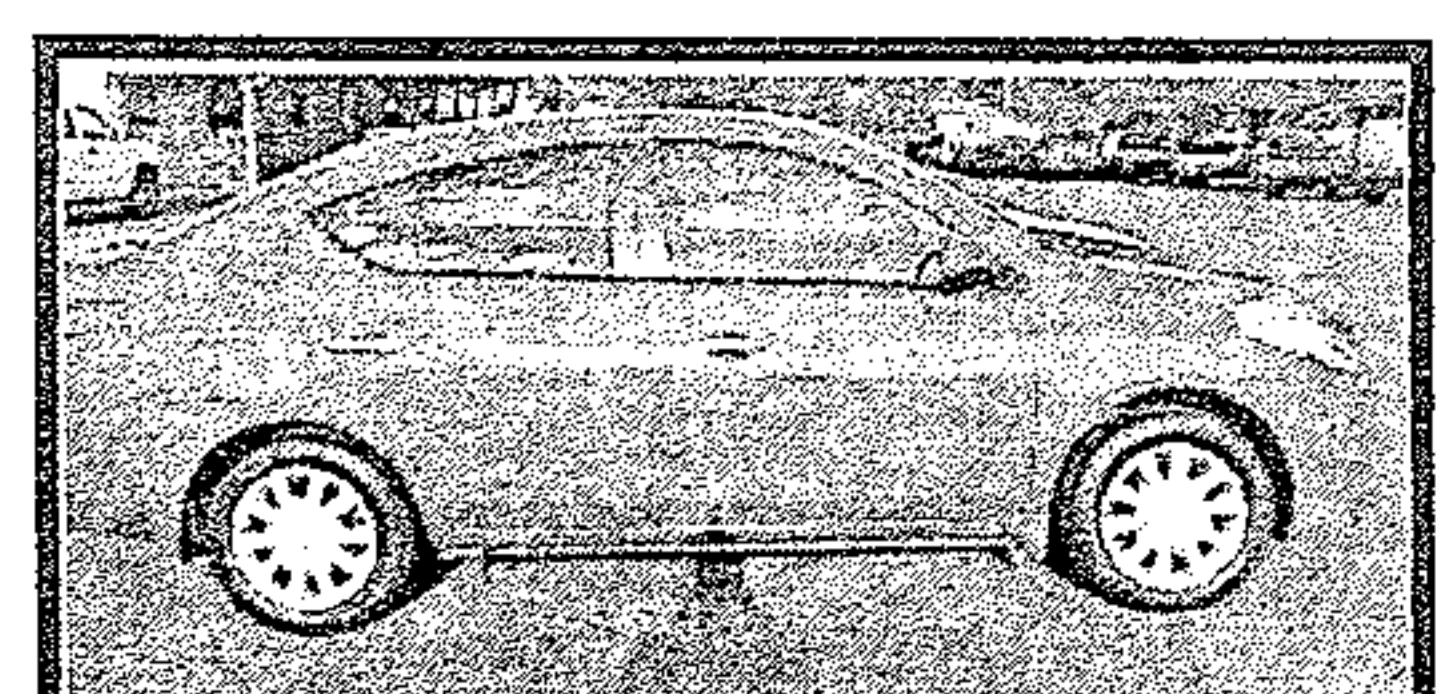

2013 Nissan Versa, Like New!
LOADED!!!

WALT WILLIAMS, INC.

*with approved credit

3003 Highway 11 Lenoir City, TN **865-986-1111**