

The Daily Edition

50¢

Serving Loudon, Monroe and Surrounding Counties

Thursday, March 10, 2016

Teen nabbed while eating the weed!

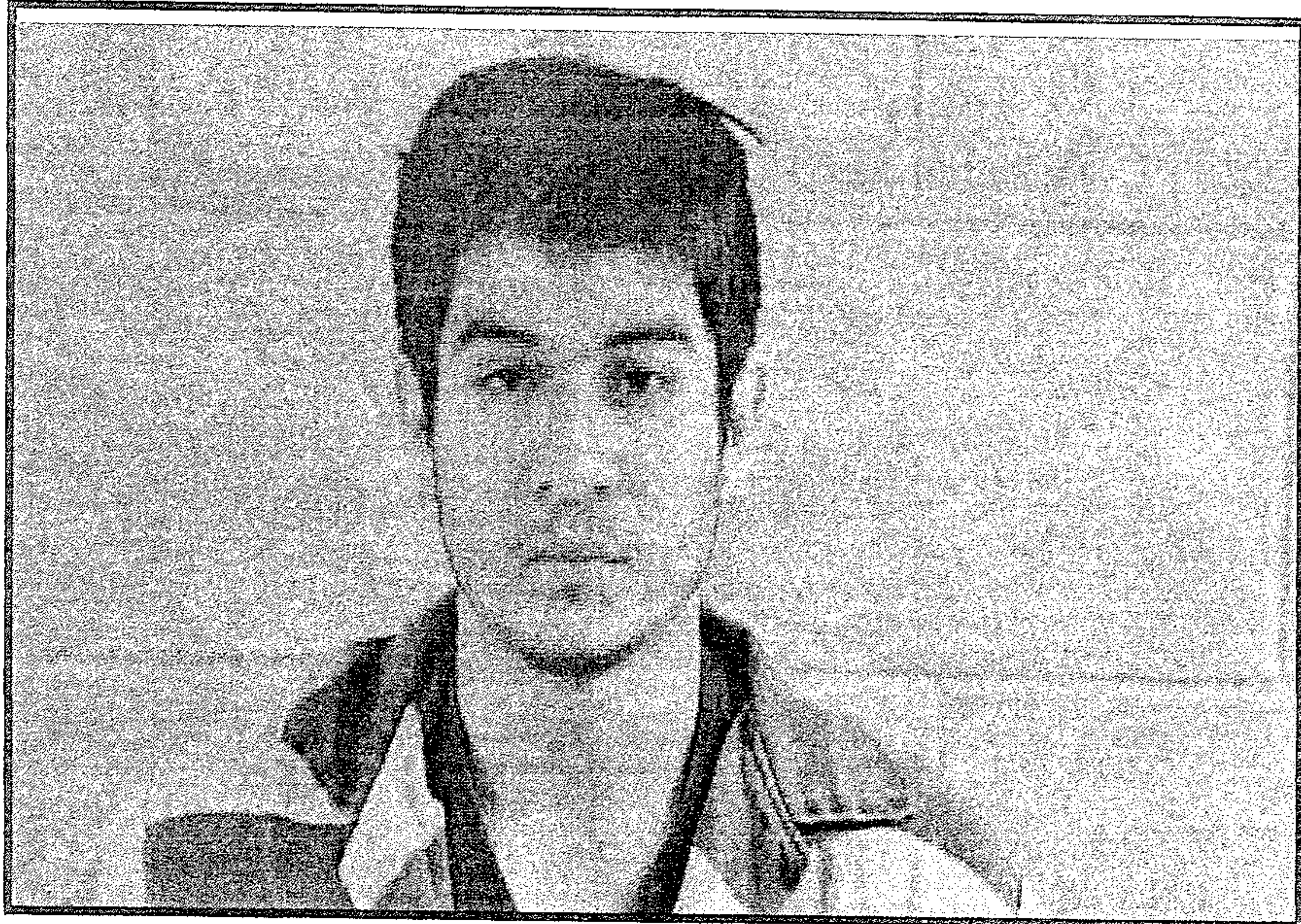

Jose Cortes

(see weed pg. 2)

Couple charged in DUI traffic stop

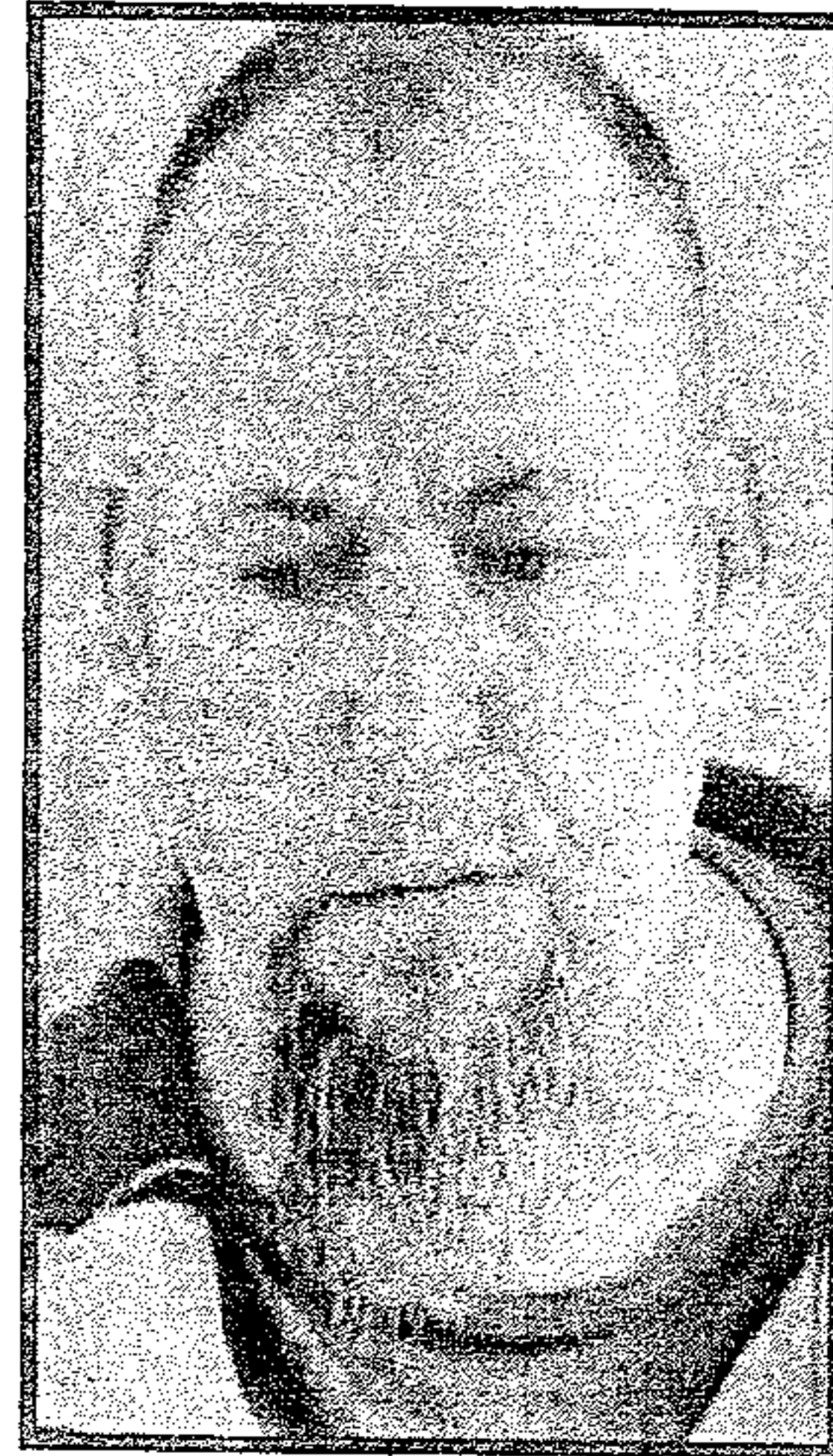

Jack Christian



Amanda Windham
(see couple pg. 5)

Knoxville FBI Agent In Charge speaks with Members of the American Legion Post 256

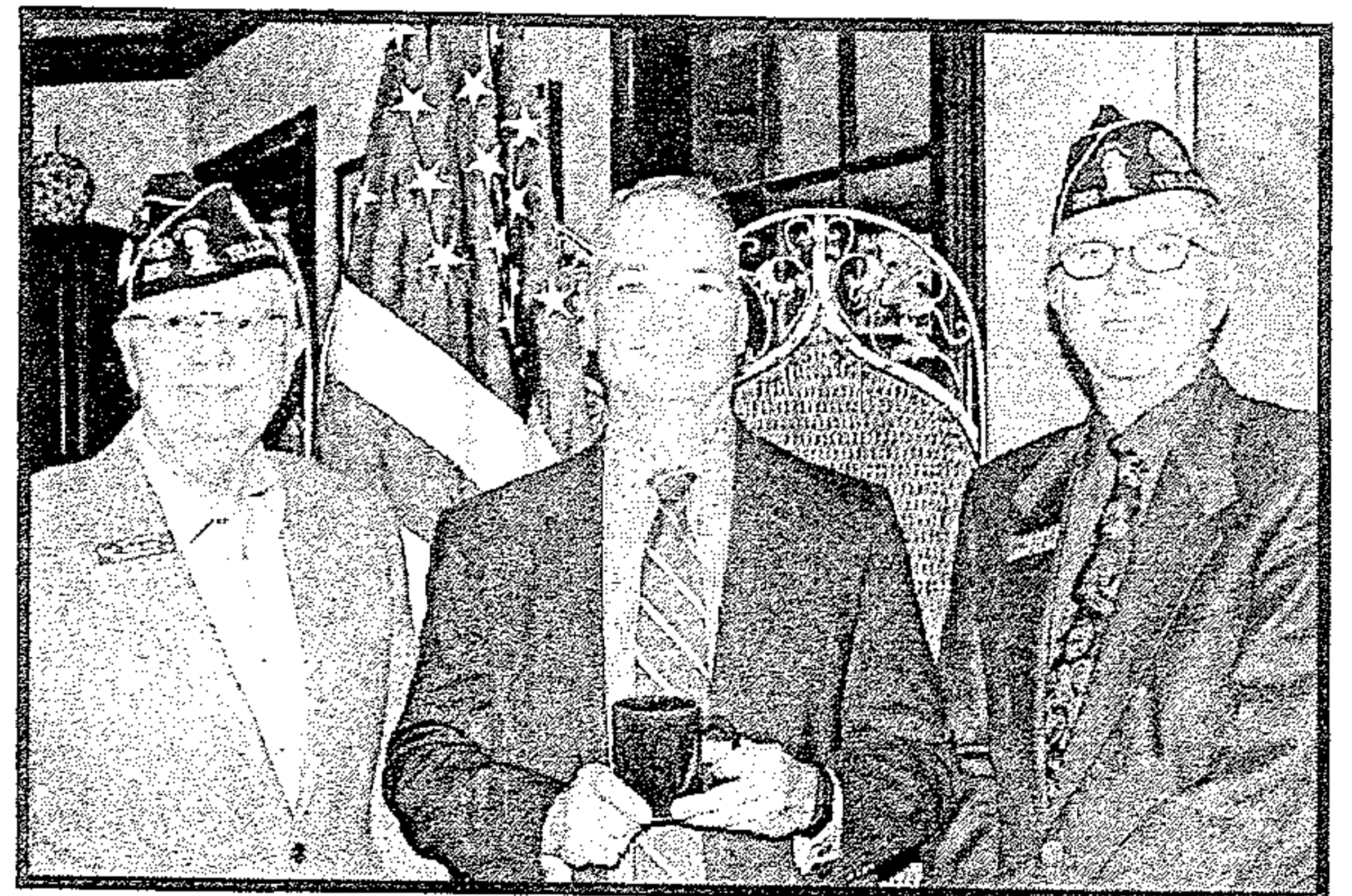

(L to R) Vic Vickery, American Legion Commander, Post 256; Edward W. Reinhold, FBI Special Agent in Charge of Knoxville Division; Pat Brooks, Vice Commander Post 256 (photo by James Patterson)

Lottery Fraud

Scammers Target the Elderly

The telephone call came from out of the blue. The man on the line told the 83-year-old retired schoolteacher she had won a substantial lottery prize. All that was required to claim the windfall was to pay taxes and other fees.

Before it was over, the victim—a Virginia resident who had meticulously saved for her retirement—was out more than \$500,000 in a scam that has become all too familiar among the elderly.

The criminals behind these lottery frauds and other telemarketing scams

(see fraud pg. 7)

GOOD SHEPHERD CENTER DINNER AND AUCTION

The Good Shepherd Center of Monroe County will hold its annual fund raising Dinner and Auction on April 2, 2016.

The location will be at the Telli-co West Conference Center, 121 Grand Vista, Vonore TN 37885.

The silent auction will begin at 5:30 PM and the catered dinner will be at 6:30 PM.

(see GS pg. 5)

Verse of the Day

When Christ, who is your life, appears, then you also will appear with him in glory. — Colossians 3:4

Obituaries

see inside

Wazzup

LCPD is working a big time Click it or Ticket Drive so be sure to buckle up or you WILL get stopped in Lenoir City!

Weather

Today: Partly cloudy skies. High 77F.
Tonight: Cloudy with showers. Thunder possible. Low near 60F.
Friday: Cloudy. High 73F.

Friday Night Cloudy Low near 55F.

Horoscopes

Pisces 2/19-3/20

Taking a long hard look at your finances is top priority now, but unfortunately this isn't just about bal-

(Continued on page 6)

(see Legion pg. 3)



weed

Jose Cortes, 18, Ivy Avenue Lenoir City, was charged with Resisting Arrest, Tampering/Fabricating with Evidence, Evading Arrest, Man/Sell/Poss of Controlled Substance, and Poss. of Drug Para. Sgt. Mike Newman and Officer Bryan Blakney LPD, made contact with Jose Lopez after

a brief pursuit where Jose finally stopped in the parking lot of Paul's Tires. While Officer approached the vehicle Officer observed Jose stuffing something in his mouth in an attempt to conceal or destroy something. After making contact with Jose Officer observed it to be a green leafy substance believed to

(see weed ctd. pg. 4)

Call 865-771-2249 to Advertise and start saving today!
Has your group got an event coming up?
Let us know!!!

To Get a Burning Permit:
 Loudon (865) 986-8395
 Monroe (423) 442-7401
 Roane (865) 354-1054

Notice: The Daily Edition does not knowingly accept fraudulent or misleading materials. The Daily Edition cannot guarantee the validity of offerings or statements contained herein. All liability for the contents of all advertising, and for any claims that may arise therefrom, is the responsibility of the advertiser or its agency. The Daily Edition reserves the right to reject, edit, or abbreviate any advertisement submitted. Advertising is accepted with the understanding that all liability for all copyright violations is the sole responsibility of the advertiser.

Photographs, artwork and other copy submitted for publication is considered the sole property of the advertiser. The Daily Edition will make every effort but will not be liable for failure to publish and ad or for typographical and layout errors. All statements and information about highlights featured items, letters to the editor, herein are those solely given to the interviewer or writer and the Daily Edition assumes no responsibility of the accuracy or validity thereof. The Daily Edition will gladly reprint at no charge that part of an advertisement in which an error occurs provided a claim is made within 3 days of the first publication of the ad. Information contained in the Wazzup is received anonymously and the Daily Edition assumes no responsibility for information and reserves the right to edit or reject any and/or all submissions. The Daily Edition is a daily newspaper of general circulation in Loudon County defined under TCA 2-1-104(a)(13).

The Daily Edition also serves Monroe, Knox, Anderson, Roane and Blount counties and serves 30,000 readers weekly. Send mail to PO Box 1240, Lenoir City TN 37771. 865-771-2249. email: dan1204us@yahoo.com

The Daily Edition is Loudon County's premier public interest and paid advertising paper. The Daily Edition is produced and published daily Monday through Friday and is circulated throughout Loudon County and parts of Monroe and Knox Counties. Display advertising rates \$5.00 per column inch and quantity discounts available. Call for information on upcoming promotions and events.

HACIENDA Ayala's
Mexican Restaurant
 Market Dr. * Lenoir City (In Front of Food City)

Real Authentic Mexican Food at Affordable Prices

BEST MARGARITA

You've Tried The Rest
 Now Come Have The Best!!!

We Accept ALL Competitors Coupons Outside of Mexico City!

986-3553

Good Credit OK • Bad Credit OK • Bankruptcies OK • Repo OK



2010 Kia Soul Sporty, 4 cyl, Auto, PW, PL, A/C, Great On Gas, Like New



2010 Ford Escape Limited Leather, Alloy Wheels, Heat, A/C, Luggage Rack, 79K,



2007 Dodge Ram 1500 Quad Cab, Thunder Road PKG, 20 in. Wheels, Low Miles, Hemi



2008 Ford Explorer 84k, 3rd Row Seating, Luggage Rack, Tow Pkg, PW, PL



2011 Ford Ranger Low Miles, Tow Pkg, New Tires, A/C, Heat, Bed Liner.



2011 Dodge Grand Caravan DVD, Stow & Go, Loaded, Remote Doors, Rear A/C

DEPENDABLE MOTORS 986-9343

803 E. Broadway • Lenoir City

Serving Loudon County for 20 Years

* WAC. See Dealer for details

Visit our website at: www.dependablemotorslc.com

legion

Edward W. Reinhold, Special Agent in Charge of Knoxville Division recently met with members of American Legion Tellico Lake Post 256. As guest speaker, Mr.

Reinhold discussed many of today's challenges for the FBI, from cyber security to concerns with more people joining militias and "Patriot groups". Special Agent Reinhold was also in charge of the investigation of the fatal shootings at the Navy reserve facility in Chattanooga, Tennessee in July 2015. That event as quoted by the Director of the FBI, was "mo-

tivated by foreign terrorist organization propaganda". 423.884.6476 and visit the For more information about Post 256 website: www.telli-the-American-Legion.com contact colakepost256.org

For Sale: oak Wood Mulch

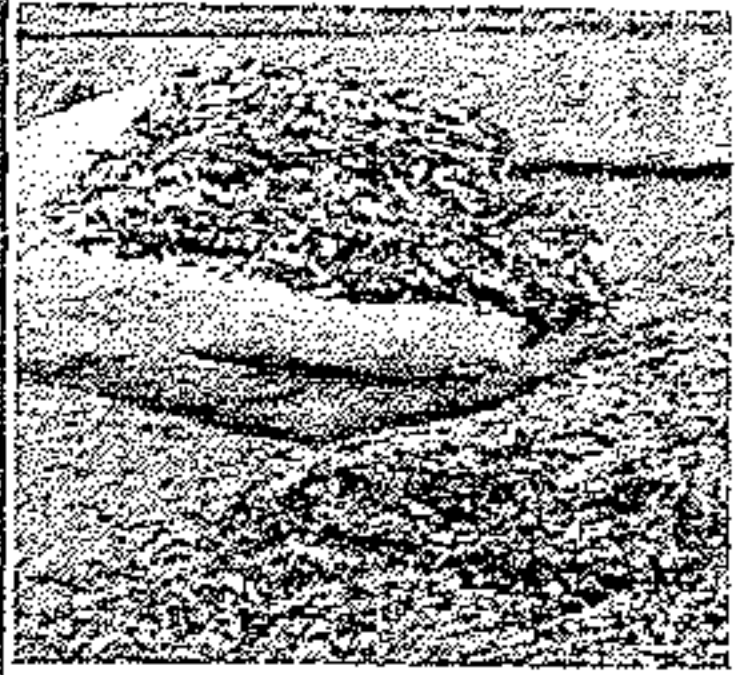

Mushroom Compost Topsoil.

Firewood

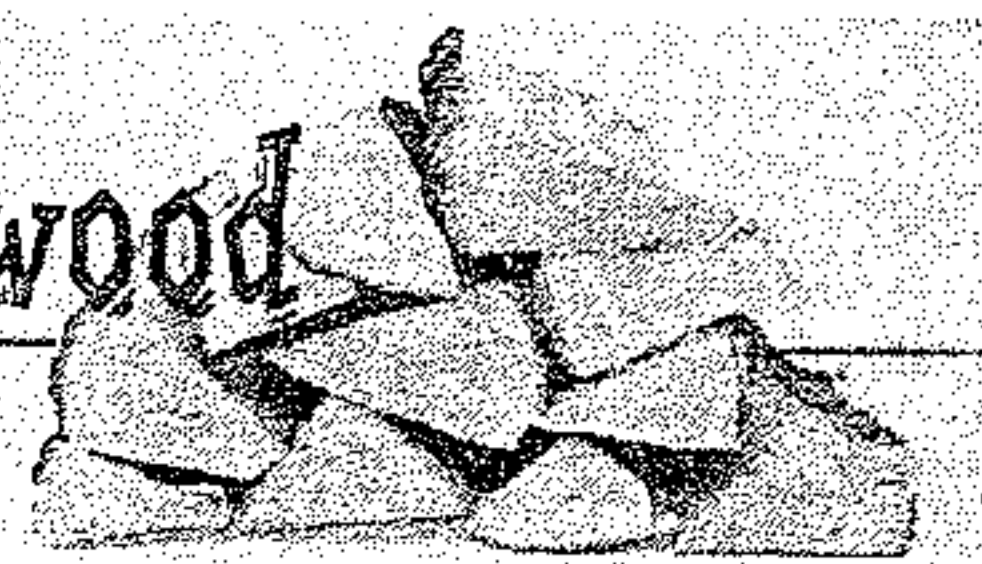

Call Steve Spoon
986-4282

The Daily Edition

serving Loudon and surrounding

counties since 1986

C&C Lawn Care
Mowing, Mulching, Trimming, Edging, Clear Debris
Free Estimates
Call Chad 865-271-8070

West End Storage & Warehouses
502 Ward Avenue • Loudon
Call 865-458-4774 or 865-679-5555

STAINED INK
TATTOO & PIERCING
LENOIR CITY 865 816-6440
NEW OWNER • NEW ARTIST • SINCE 2011
521 Hwy 321 next to Vape & Stuff & Inn Of Lenoir!
Clean-Affordable-Quality-Custom
Tattoo's You've Always Wanted!

BRING IN THIS AD FOR **\$25 OFF!**
NEW INK FOR NEW CUSTOMERS ONLY!

Check us out on FB.com/
Stained.Inc.Tattoo/
www.STAINEDINC.com

C&J Towing and Recovery
LOWEST TOWING RATES AROUND!!!

Have you been overcharged for any type of towing service in the Lenoir City area? If you have a breakdown or accident please OWNER REQUEST C&J Towing with the officer. Also please call your Sheriff and ask him to place C&J Towing on the "Rotation List*" and help other motorists save as much as you did! We at C&J are locally owned and operated, State approved, licensed, bonded and insured. Call and let us know if your denied service or how we can be of assistance.

*note: the "Rotation List" is a list of wrecker services that provide service for wrecks, DUI's, breakdowns, etc. and are on an on-call basis for service. This list is approved by the Sheriff.

Cliff Teeters • Owner
865-809-1661

BIMBO'S
Deli Open 24 Hours
865-986-9643 Call Ins Welcome

Specials
Lg. Cold Sub, bag of chips and 16 oz. fountain drink
only \$6.29
Footlong Corn Dog \$2.59

weed ctd. from pg. 2
be marijuana. Jose was ordered to get out of the vehicle and spit out the substance several times but failed to do so. Jose was removed from the vehicle while removing him Jose reached in his pocket and tried to stuff the remaining Marijuana in his mouth. Jose was told to spit it out which he refused again, while

Sgt. Newman placed hands on Jose to place him in custody Jose jerk away and turned towards Officer in an aggressive manner. Jose was taken to the ground and continued to try to stuff the substance in his mouth and resist Officers. To gain control of the situation Officer deployed a dry stun from the taser and Jose quit resisting. Jose
(see weed ctd. pg. 5)

Help Wanted

**Experienced
Dispatcher
Needed At
Moneymaker
Wrecker Service**
Apply in person
at 11776 Hwy
70, Lenoir City

BUDGET *Transmissions*

302 S. Northshore Drive Knoxville

(865) 584-4391 budget-transmissions.com

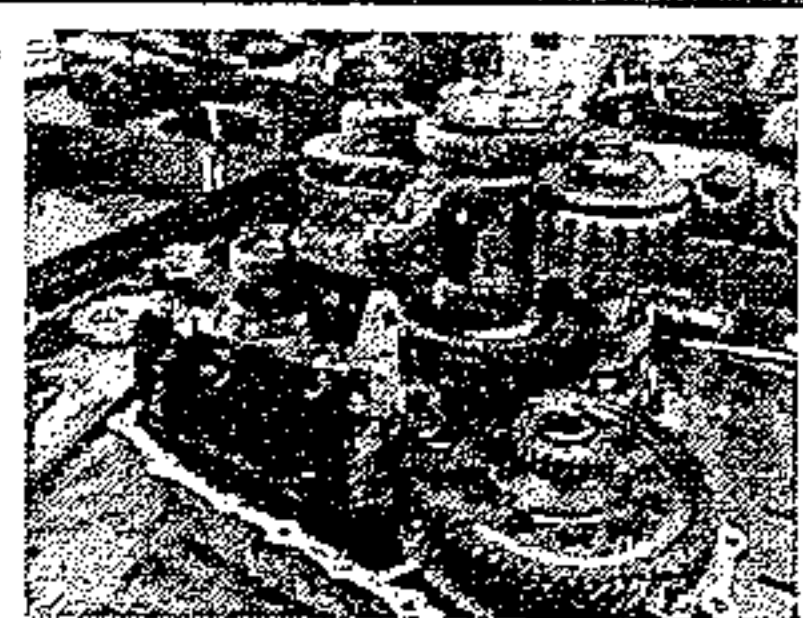

Why Buy From Budget?

Free Towing From Lenoir City
or Loudon County

20 Years of BBB Zero Customer
Complaints Award Member
A+ Plus Rated

Huge Transmission Inventory

Best Technicians Period!!!

Call (865) 584-4391 Today!



Approved
Auto Repair



NEED HELP WITH INCOME TAX? PROFESSIONAL TAX SERVICE

PRICE - 95% of returns between \$60-\$140

(No Coupons Required)

LOCALLY Owned & Operated - Open Year Round

30+ Years in the business

ALL Preparers with 10+ years experience

Pro Tax

111 E. Broadway

Lenoir City, TN 37771

Phone 865-986-4035

**US Armed Service Active Duty Personnel, "THANK YOU", Tax Return Free*

good
to know
you™

IMMEDIATE OPENINGS!

Randstad is NOW HIRING for 2nd shift Assembly Positions at Commercial Vehicle Group. These are long-term, temp-to-hire positions!

Hours: 4:30pm - 3:30am (end times vary)

Pay: \$10/\$10.50 per hour

You may apply by visiting our Facebook page www.facebook.com/vonorejob and clicking the "Sign Up" button. You can also get a paper application from the Guard Shack at 200 National Drive, Vonore, TN 37885.

For questions, call 423.884.4733

www.randstadstaffing.com

EOE

randstad

Staffing | Professionals | Search & Placement | HR Solutions | Inhouse Services

couple

Amana Windham, 33, Caldwell Road Loudon, was charged with DUI by Consent, and Simple Possession.

Jack Chriatian, 45, Caldwell Road Loudon, was charged with DUI, Driving on Revoked License, and Violation of Implied Consent.

Deputy Robbie Lane LCSO, observed a sil-

ver truck traveling east on Fork Creek Road. The truck crossed over the center yellow line and white fog line several times. Deputy conducted a traffic stop on Fork Creek @ Steekee Creek Road. Deputy made contact with the driver Jack Christian, who had red watery eyes, slurred speech and a strong odor of alcoholic beverage coming from inside the vehicle.

Jack exited the vehicle and was unsteady on his feet and could not perform sobriety test. Jack was placed under arrest. The passenger and owner of the vehicle Amanda Windham, had red watery eyes, slurred speech and a strong odor of alcoholic beverage coming from her person. Amanda allowed Jack to drive the vehicle knowing he was under the influence.

Amanda was ask if she had anything on her person that was illegal, Amanda stated she had some marijuana in a plastic wrapper in her front pocket. Amanda was placed under arrest. Deputy Robbie Lane LCSO, made the arrest.

GS

Entertainment will be the dynamic singing duo known as Vocal Point.

Tickets are \$40 each,

of which 20 dollars is income tax deductible. For those who wish to support the Good Shepherd but are unable to attend this function, there are Feed a Family tickets available, also \$40 each.

Tickets may be purchased at The Good Shepherd Center, The Monroe County Chamber of Commerce, the Kahite Club House and individual Good Shepherd volunteers.

The Good Shepherd Center is a 501©3 organization.

Some of the things The Good Shepherd Center provides are food to over 2,100 men, women and children every month, personal care items as requested, clothing to each person per household, miscellaneous items each month, transportation via ETHRA for medical appointments, emergency housing for fire victims, layette sets for newborn babies and utility vouchers.

The Good Shepherd Center is supported financially by churches, local businesses, and individuals. Additional funds are provided through grants, auxiliary groups, Monroe County governmental agencies and fundraising events such as this Dinner/Auction event.

weed ctd. from pg. 4

was taken in to custody. A search of the vehicle revealed several small baggies throughout the vehicle and some baggies in the glove box that contained a green leafy substance that were packaged consistent for resale, 2 packs of rolling papers were also found. officer Bryan Blakney LPD, made the arrest.

PURDY'S AUTO PARTS AND SALVAGE

WE BUY SCRAP IRON • COPPER • BRASS • ALUMINUM

\$ **Paying Top \$\$\$**
Call For Latest Prices

You Name It, We Buy It!

Radiators, Wheels, Batteries, Appliances, Farm Equipment

Copper
Paying Top \$\$\$
Call For Latest Prices

Complete Cars
per 100 lbs.

Scrap Metal
Paying Top \$\$\$
Call For Latest Prices
per 100 lb

We Buy Batteries

Aluminum Cans
Paying Top \$\$\$
Call For Latest Prices

You Call We Haul!

423-519-5402

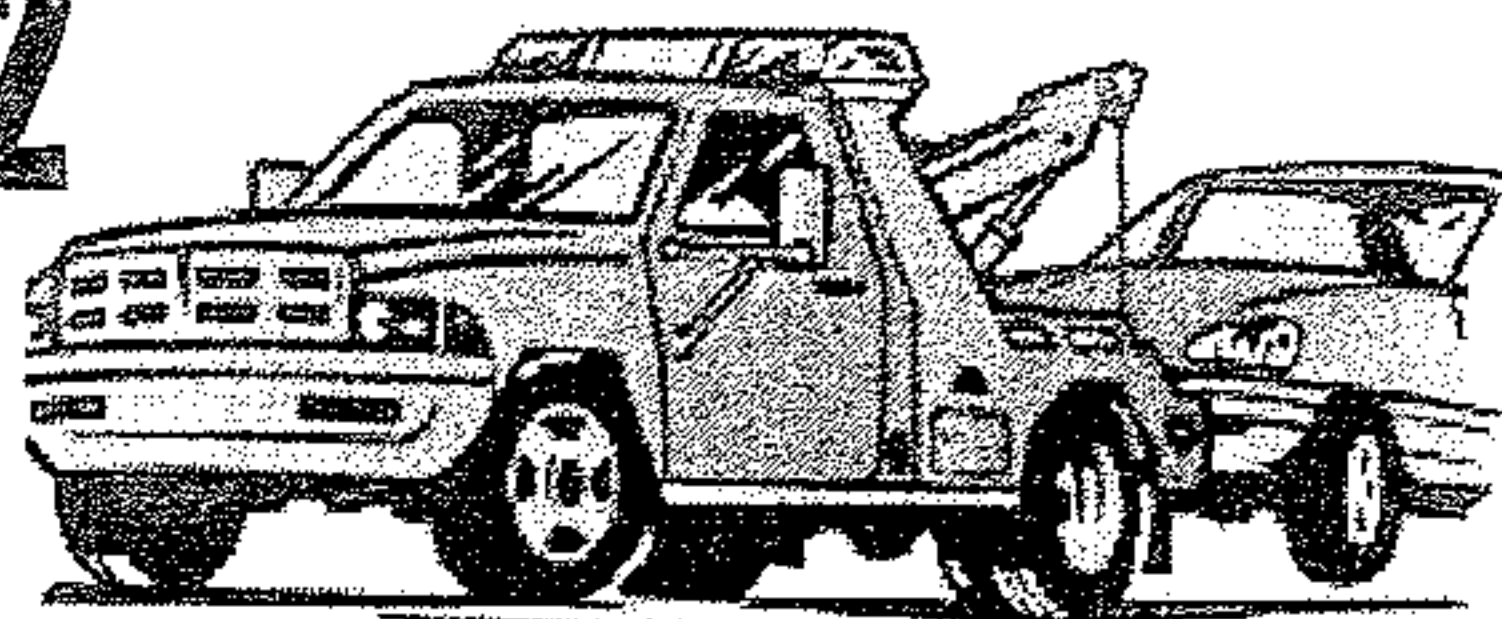

Prices subject to change with the market.

423 337-3977

149 County Road 323 Sweetwater

**Now Selling
Aftermarket
Body Parts at
Discount Prices**

Prices subject to change with the market.

fraud

prey on senior citizens for a variety of reasons, according to Special Agent John Gardner, who investigated the woman's case out of the FBI's Washington Field Office and eventually helped put the Jamaican man who victimized her behind bars.

"The first thing to know is that lottery scammers have no empathy for the elderly," Gardner said. "For them, it's all about the money." Seniors can be lured into the scam because they have financial difficulties, or they might have enough for themselves but want to leave a legacy for their children. Some may be suffering from mental decline or dementia. "Others are so lonely, they just want someone to talk

to," Gardner explained. "Some scammers become 'best friends' with their victims."

There is also the issue of technology. The criminals—many who carry out their crimes from Jamaica—use Internet tools to mask their calls so they appear to be coming from U.S. numbers with particular area codes, such as Las Vegas.

"Elderly people grew up at a time when people weren't defrauding people over the phone," Gardner said. "They are not aware of these Internet masking technologies and are generally not suspicious when the tele-

phone rings."

The fraudsters are as persuasive as they are sophisticated. "The Jamaican lottery scammers are like an organized cyber crime group," Gardner said. "They are closely knit, highly structured, and have U.S. associates—money mules—who help launder their money."

The scammers who make the calls speak excellent English and use well-practiced scripts complete with rebuttals. They are experienced and extremely manipulative. To target victims of a certain age, they buy lead lists that are widely available online.

Gardner received the Virginia woman's complaint in 2011. The ensuing investigation eventually resulted in the identification of seven subjects, all of whom

were charged in connection with the lottery scheme. Six of those individuals have been convicted, and one is a fugitive. The ringleader, Paul Laing, 31, of Sandy Bay, Jamaica, was sentenced last month to 10 years in prison for his leadership role in the scheme.

Laing pled guilty in October 2015, admitting that he defrauded numerous elderly victims, including the woman from Virginia who lost her life savings. Laing instructed victims to send funds through wire transfers, the U.S. mail, and other means directly to him in Jamaica or to co-conspirators in the U.S. Those co-conspirators—the money mules—kept a portion of the proceeds and transferred the rest to Laing. The illicit funds ran to hundreds of thousands of dollars from

more than 23 known victims, Gardner said, adding that there were likely many more victims who never came forward.

Don't Fall Victim to Lottery Scams

The Federal Trade Commission—the nation's consumer protection agency—offers the following advice to avoid falling victim to lottery scams and other telemarketing frauds:

- Don't pay money to collect supposed lottery or sweepstakes winnings. If you have to pay to collect, you are not winning, you are buying. Legitimate sweepstakes don't require you to pay insurance, taxes, or shipping and handling fees to collect your prize.

- Scammers pressure people to wire money through commercial

see fraud conc. pg. 8

Help Wanted
Position Available
Immediately! Apply
in person at the Kenjo
Marathon on Hwy 321
in Lenoir City.

LOOK!
\$75 Weekly Payments
LOOK!

MARTY'S AUTO SALES • 986-2222
MARTY'S AUTO SALES • 986-2222
MARTY'S AUTO SALES • 986-2222
MARTY'S AUTO SALES • 986-2222
MARTY'S AUTO SALES • 986-2222

Bad Credit

Divorce

Fixed Income

Repos

Bankruptcy

No Credit

APPROVED!

Visit Us On The Web At:

marty'sautosales.net

NO

CREDIT

CHECKS

\$499
down*

07 Cobalt, 5spd, gas saver,
runs great Only \$499 down *

\$299
down*

99 Solara, V6, auto, sporty,
Only \$299 down *

\$599
down*

04 Santa Fe, auto, Nice,
clean. Only \$599 down *

\$499
down*

01 Sebring 2dr. sporty, Only
\$499 down *

\$599
down*

05 Trailblazer, auto, good
miles Only \$599 down *

\$499
down*

04 Aveo, auto, gas saver,
Only \$499 down *

\$799
down*

06 Tiburon GT, 5 speed,
sporty, Only \$799 down *

\$99
down*

98 Bonneville, 6 cyl, Auto, low
payments only \$99 down *

NO
Credit Checks

Marty's Auto Sales

986-2222

Se Habla Espanol

100%
Approval*

*See Dealer for details. All down payments plus tax, tag, title and fees.

MARTY'S AUTO SALES • 986-2222
MARTY'S AUTO SALES • 986-2222
MARTY'S AUTO SALES • 986-2222
MARTY'S AUTO SALES • 986-2222
MARTY'S AUTO SALES • 986-2222

FBI etd. from pg. 7

money transfer companies because wiring money is the same as sending cash. When the money's been sent, there's very little chance of recovery. Likewise, resist any push to send a check or money order by overnight delivery or courier. Con artists recommend these services

so they can get their hands on your money before you realize you've been cheated.
- Remember that phone numbers can deceive. Internet technology allows scammers to disguise their area code so it looks like they're calling from your local area, but they could be calling from anywhere in the world.

THE RELIC SHOP

521 Hwy 321 Lenoir City Suite 3
next to Stained Inc and the Inn of Lenoir
865-250-9280

WE ARE IN TUCSON, ARIZONA BUYING UP FOSSILS FOR THE SHOP. WE NEED TO MAKE ROOM!!!

ALL AMETHYST 40% OFF

GREAT SELECTION OF ANCIENT MEGALODON SHARK TOOTH OVER 8 MILLION YEARS OLD

Is Your Washer Broken?

Call Me

I Only Charge \$100 Period!!!

Call Allen

865-617-7113

A Name You Already Know And Trust Just Got Even More Dependable
DEPENDABLE AUTO SERVICE, LUBE AND TIRES
is Now Offering
Expert, Affordable Transmission Service

All ASE Certified Technicians

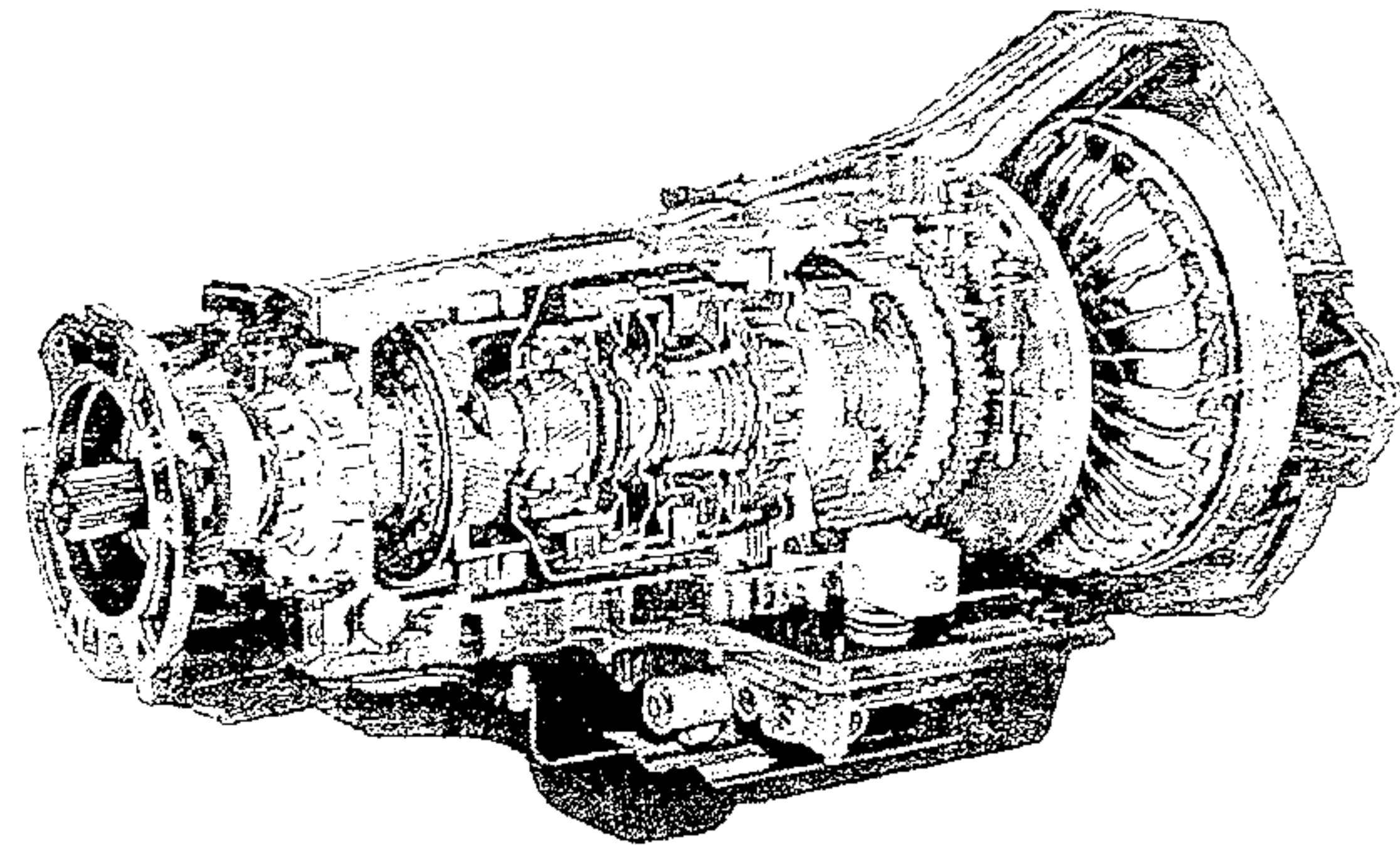

We proudly welcome all New Customers and Former Advanced Transmission Customers with a 10% Discount and Any Transmission Service or Repair*

865-986-9359

865-986-5050

Bad Credit, No Credit OK!!! We Finance Everybody!!!

Taxes Done Here!!! Bring your last pay stub or W2 and DRIVE TODAY!!!

Over 100 Cars, Trucks & Vans in Stock - Warranties On ALL Vehicles Sold!!!

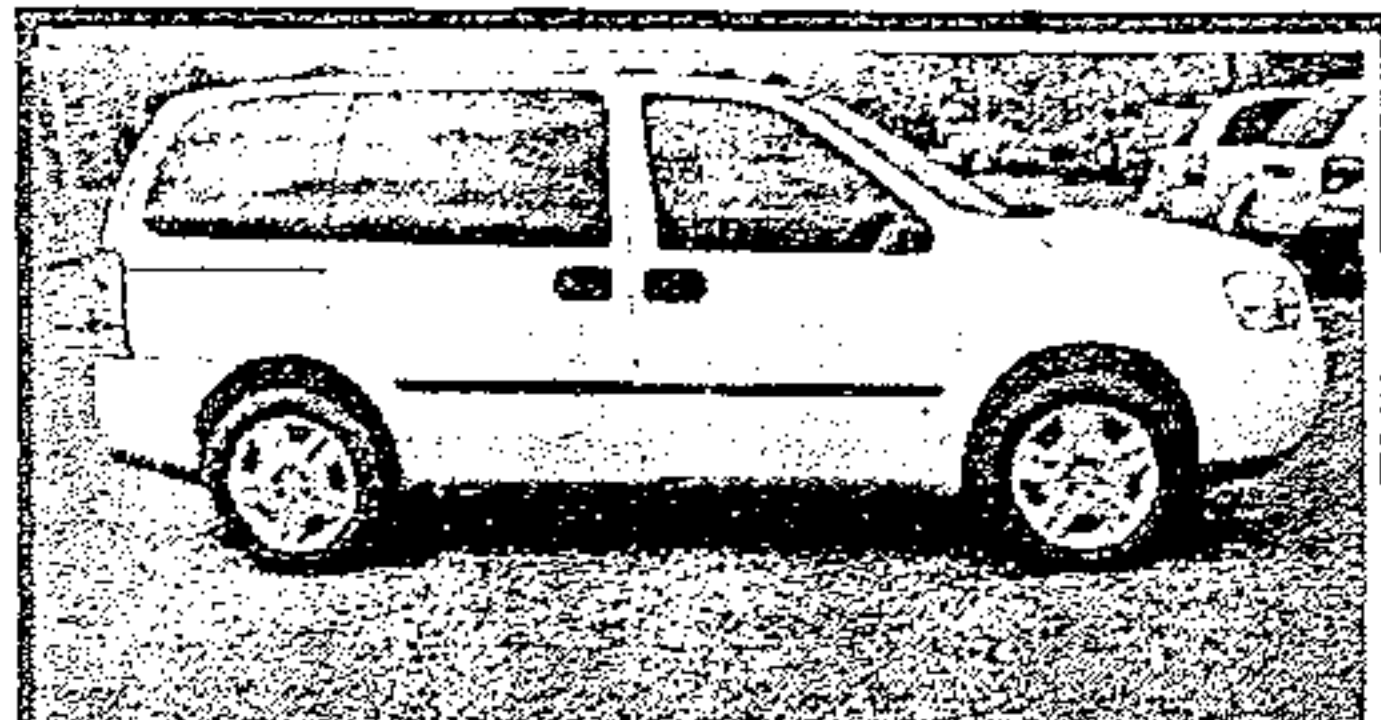

2007 Chevrolet Uplander, 60k miles, NICE!!!

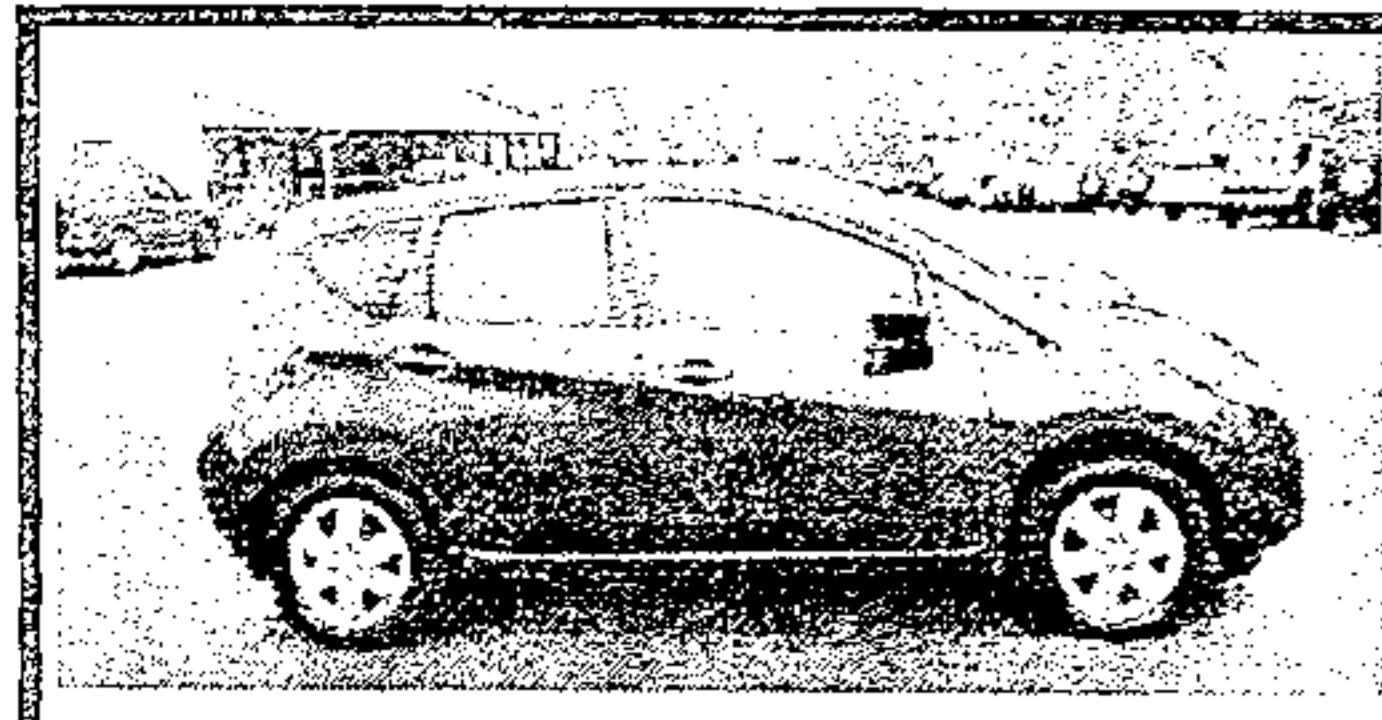

2015 Nissan Versa Note, Factory Warranty, Low Miles

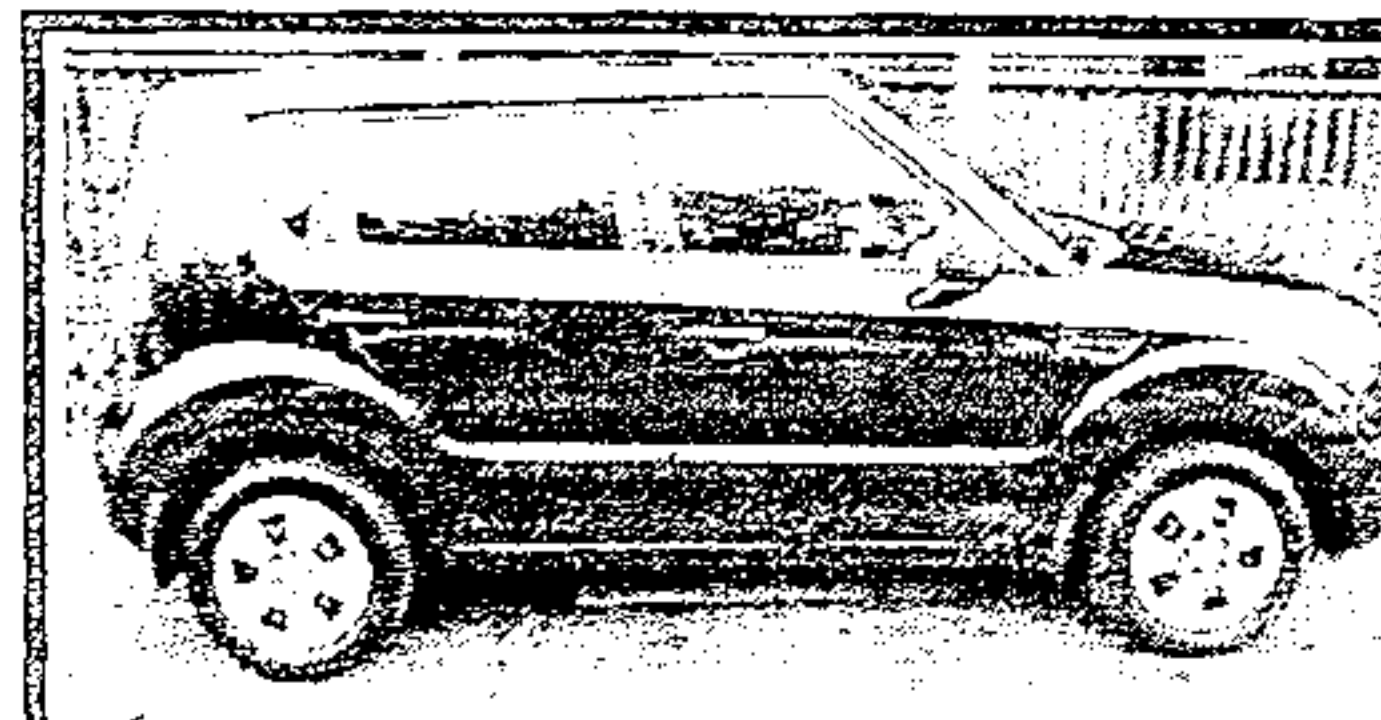

2011 Kia Soul, 5 speed, 4 dr, Gas Saver, Nice & Clean



2008 Saturn VUE, LOADED!!! 4dr, Ready to go on a trip!

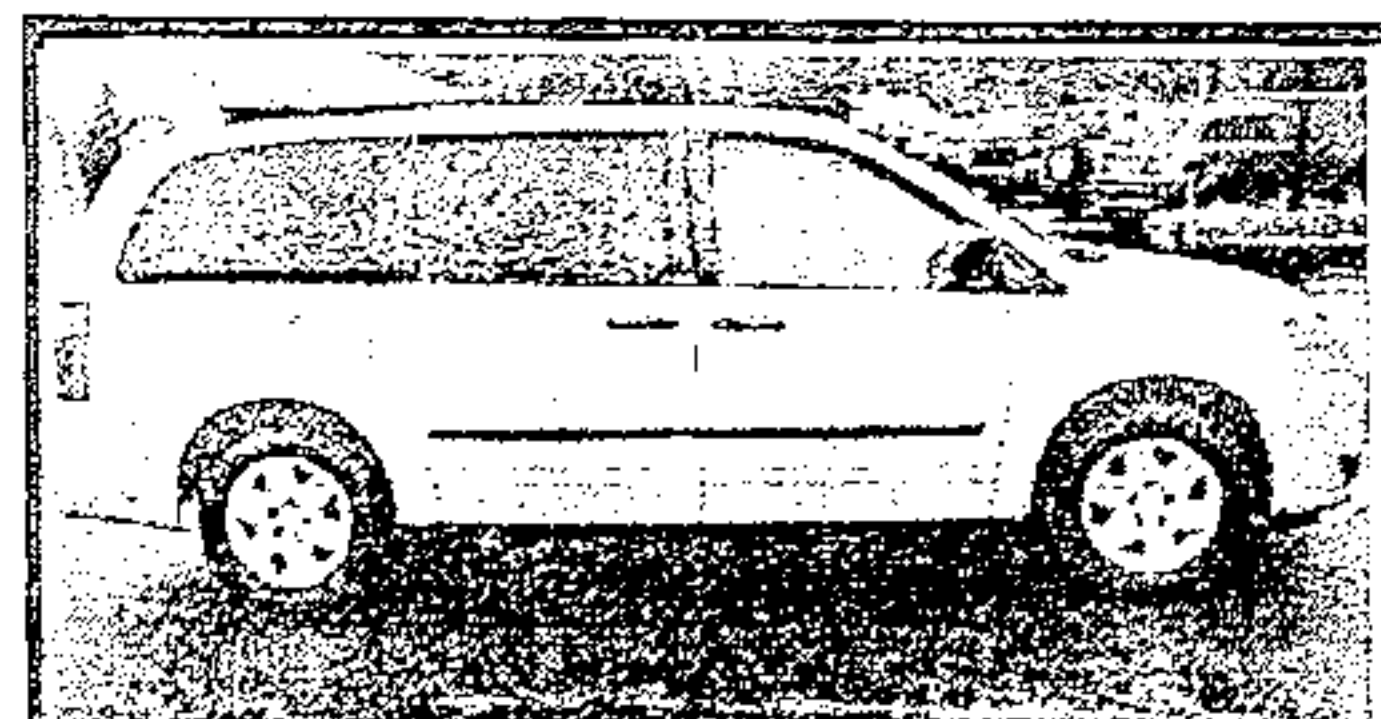

2008 Dodge Grand Caravan, Nice, Clean, Slow n Go!

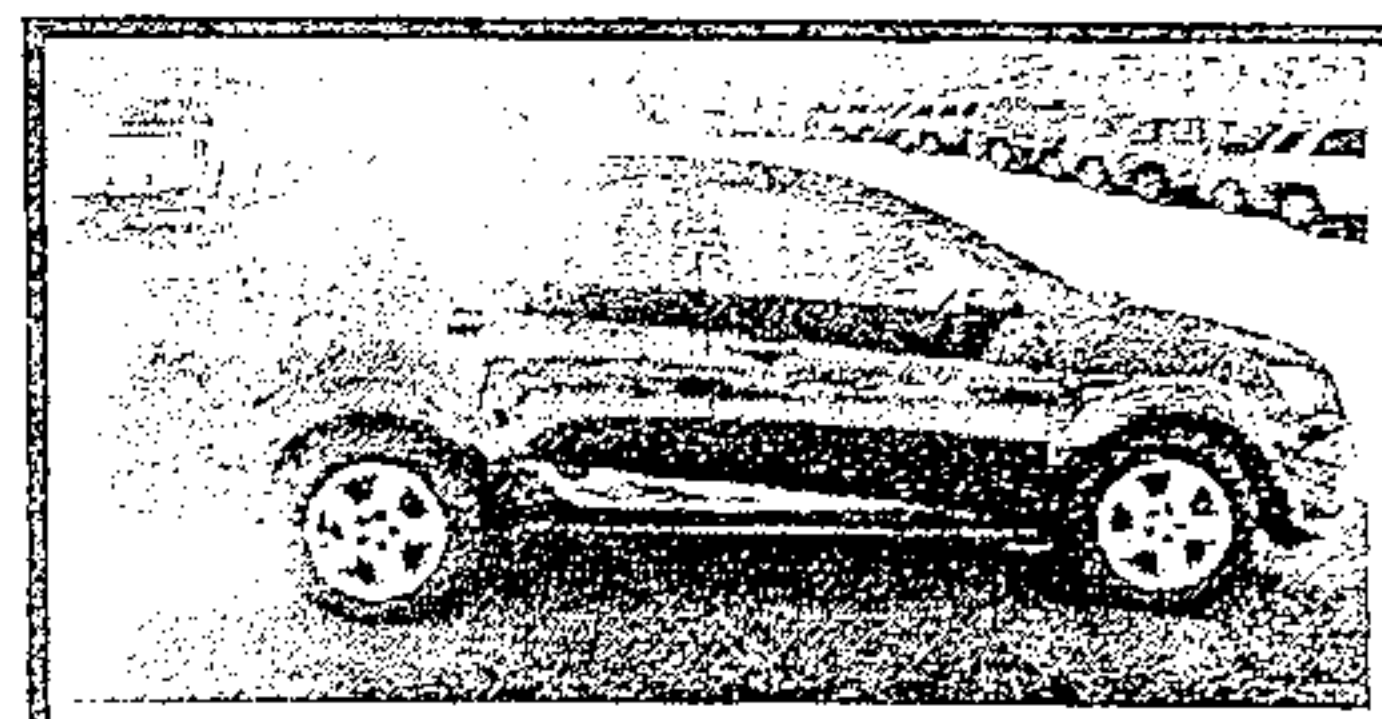

2014 Chevy Sonic, Factory Warranty, Low Miles!

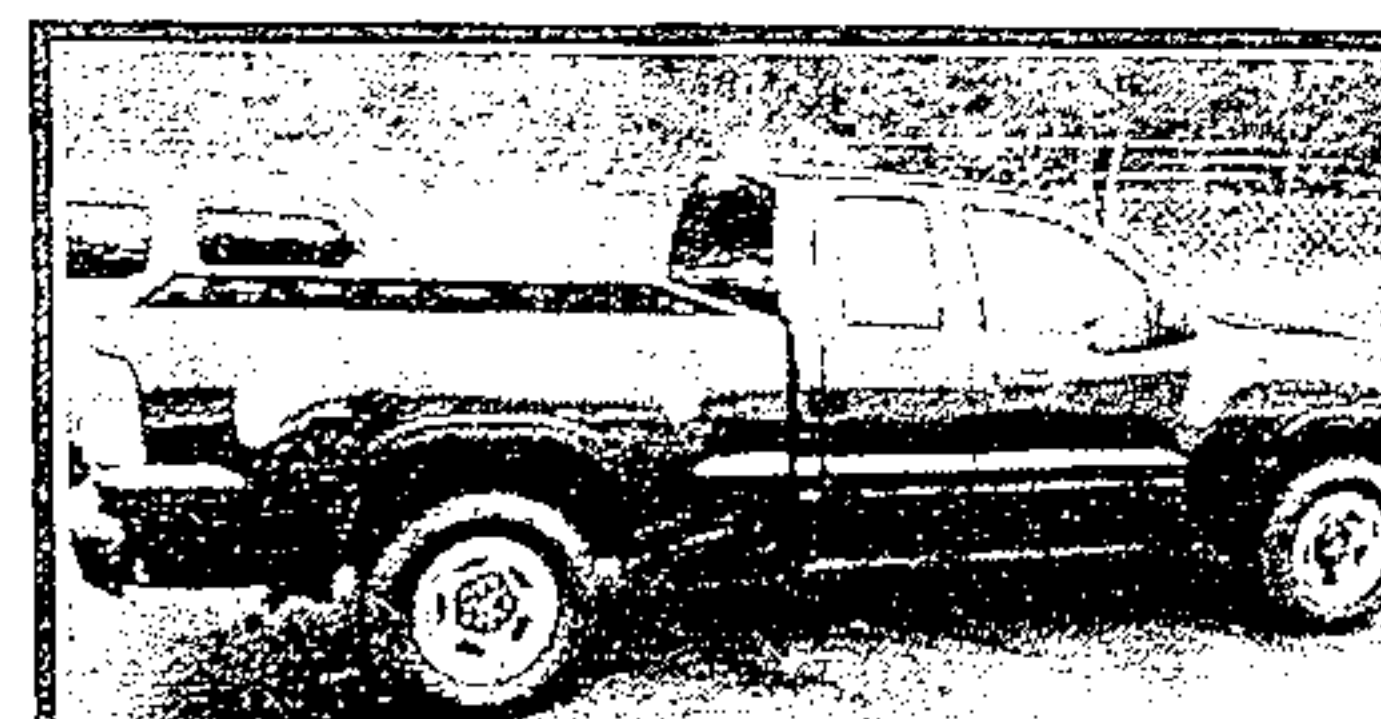

Mitsubishi Raider, Ext. Cab, Super Nice Truck

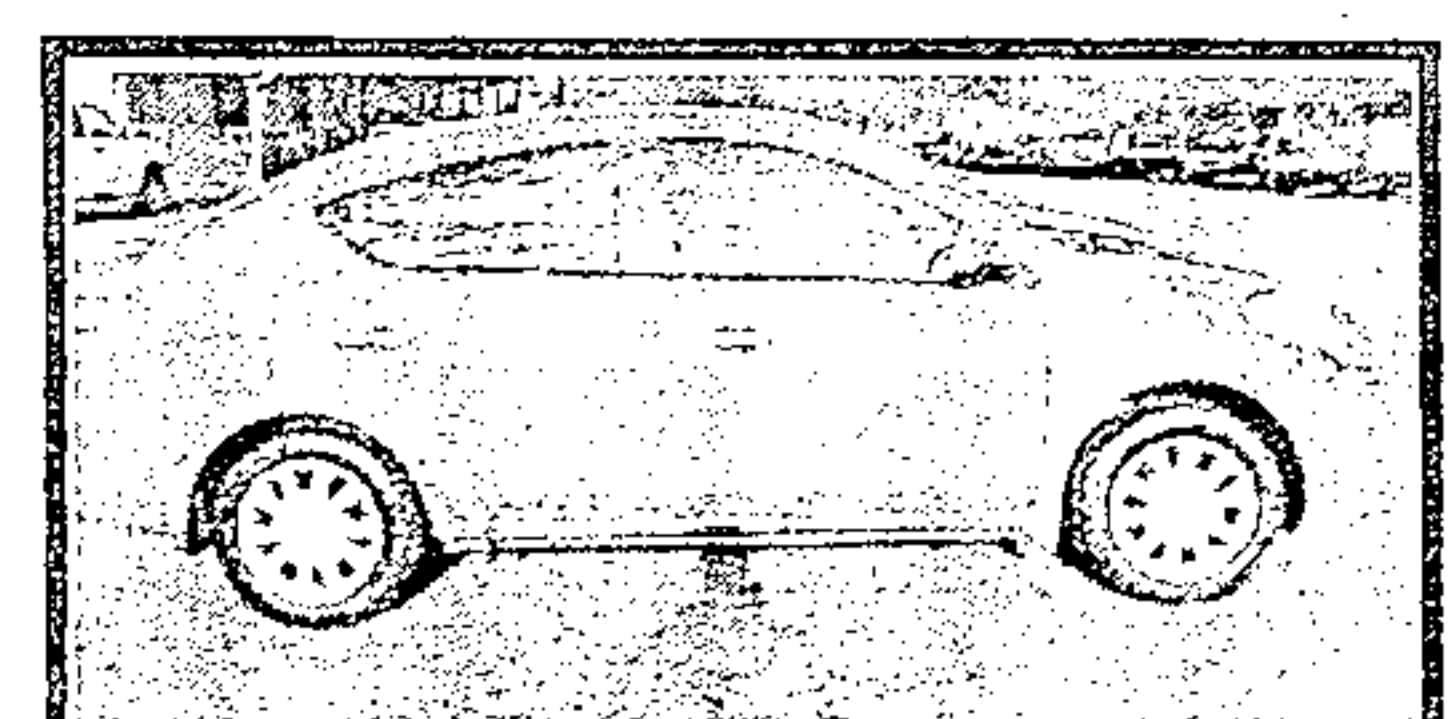

2013 Nissan Versa, Like New! LOADED!!!

WALT WILLIAMS, INC.

*with approved credit

3003 Highway 11 Lenoir City, TN **865-986-1111**