

The Daily Edition

50¢

Serving Loudon, Monroe and Surrounding Counties

Monday, February 8, 2016

Man who stole TV from Walmart then evaded police nabbed

Gary Hampton, 26, Riverbend Drive Loudon, was charged with Criminal Impersonation, Theft of Property, Reckless Endangerment, Evading Arrest, and Assisting other Agency x2.

Deputy Kevin Dailey LCSO, paced a gold vehicle at 62 in a 50 mph zone at Pond Creek and McCrary St. Upon stopping the vehicle at

(see nabbed pg. 2)

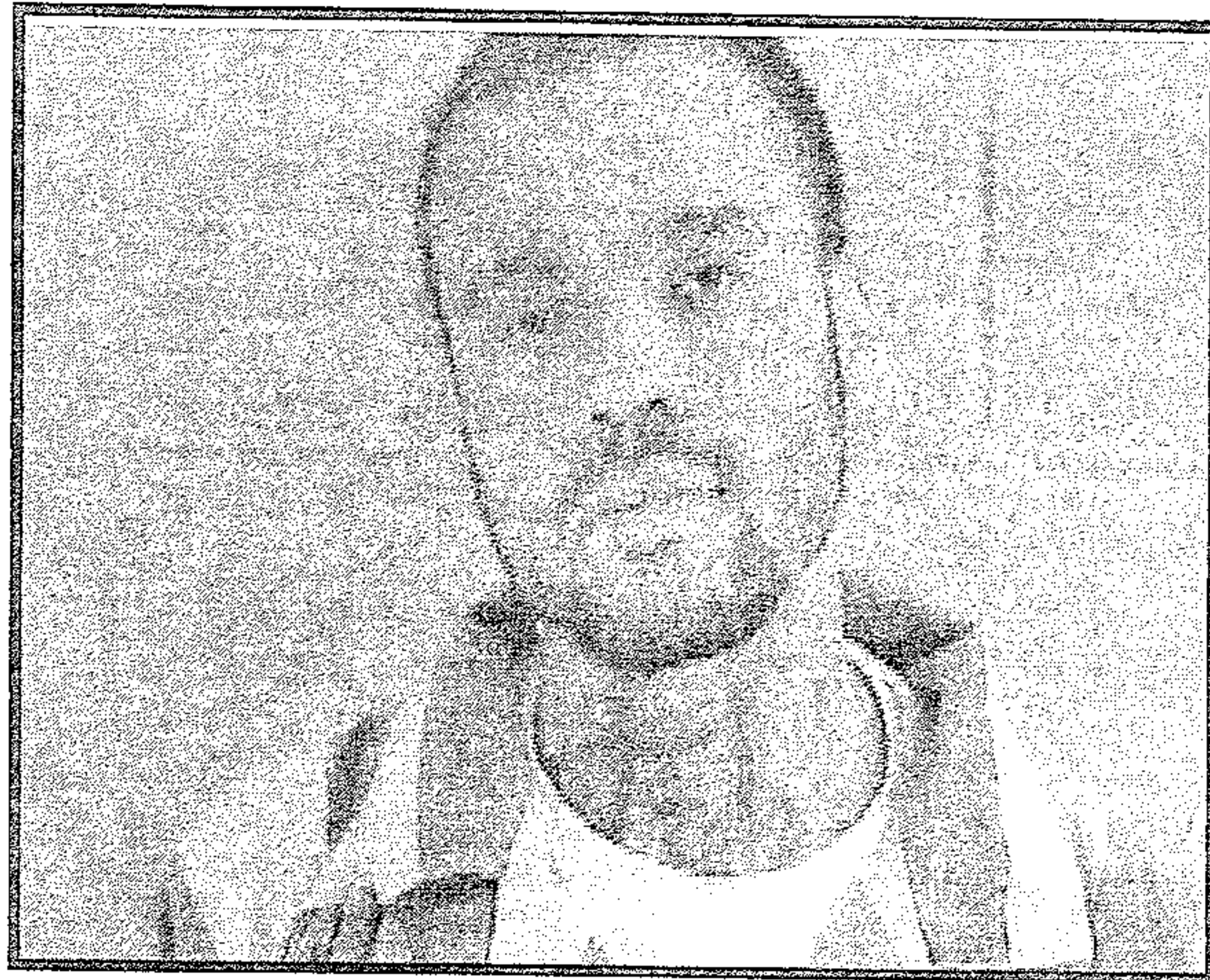

Gary Hampton

2 charged after stop for weaving by LCSO



Jared Coatney

(see stop pg. 7)



Stephanie Rutledge

Passed out in the parking lot leads to arrest

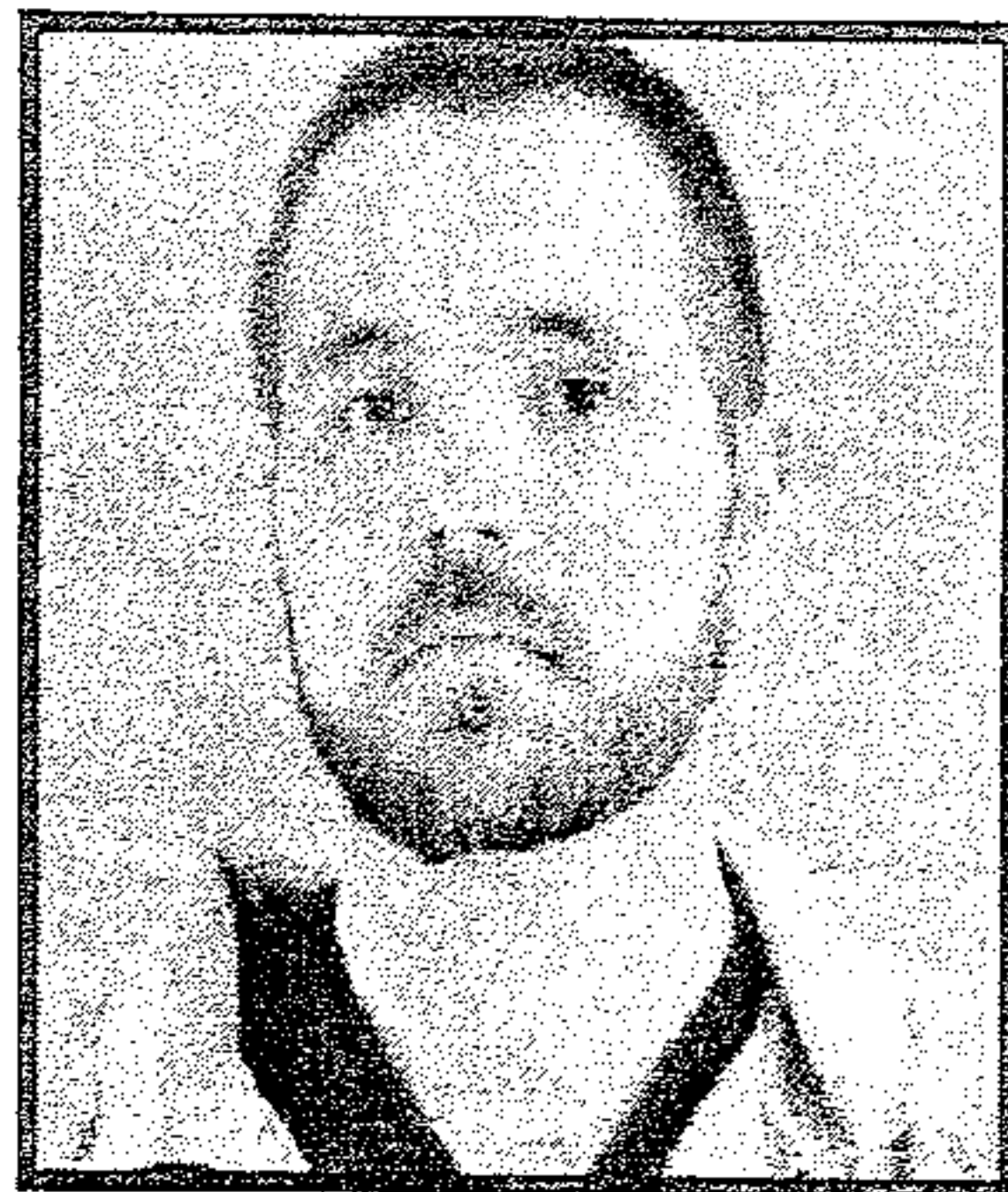

Anthony Hood

(see DUI pg. 4)

Attorney General's Smart on Crime Initiative Implemented Locally

At the direction of the U.S. Attorney General in early 2013, the

Raising Awareness of Opioid Addiction

FBI, DEA Release Documentary Aimed at Youth

Every day, the nation's law enforcement agencies at the local, state, and federal levels—including the FBI and the Drug Enforcement Administration (DEA)—use investigative resources to target the supply side in the war against drugs.

But even with numerous law enforcement successes in this area, the demand for drugs continues. And one of the more worrisome trends is a growing epidemic of prescription opiate and heroin abuse, especially

among young people.

Today, in an effort to help educate students and young adults about the dangers of opioid addiction, the FBI and DEA unveiled a documentary called *Chasing the Dragon: The Life of an Opiate Addict* at the Newseum in Washington, D.C., before an audience of educational leaders from the region. The 45-minute film, whose title refers to the

(see Documentary pg. 5)

David Elbert Hall sentenced to 120 months on Marijuana Conspiracy and Firearm Charges

David Elbert Hall, 54, of Kingsport, Tenn., was sentenced on Feb. 2, 2016, by the Honorable R. Leon Jordan, U.S. District Court Judge, to serve 120 months in federal prison for his role in an extensive marijuana distribution conspiracy centered in the

Eastern District of Tennessee and the Western District of Virginia and possessing one or more firearms in furtherance of drug trafficking.

According to the plea agreement on file with U.S. District Court, Hall admitted that between 2003 and 2015 he conspired to distribute and was accountable for at least 100 but less than 400 kilograms of marijuana. After another in-

(see sentenced pg. 4)

Verse of the Day

From inside the fish Jonah prayed ... "In my distress I called to the LORD, and he answered me. From the depths of the grave I called for help, and you listened to my cry." — Jonah 2:1-2

Obituaries

see inside **Wazzup**

How 'bout ya gonna take the big strawberry from me Ralph! Good thing they had more at the Country Kinfolks and it was awesome!

Weather

Today: Rain and snow in the morning will become intermittent in the afternoon. High 39F.

Tonight: Mainly cloudy with snow showers around before midnight. Low 23F.

Tuesday Cloudy. A few flurries or snow showers pos-

sible. High 32F. Tuesday Night Cloudy. A few flurries or snow showers possible. Low 23F.

Horoscopes

Aquarius 1/20-2/19

A vivid dream could feel so real today that you search for

(Continued on page 6)



nabbed

Fort Creek Rd and Hwy 11 contact was made with the driver also in the vehicle was a black male that gave a name of Charles but did not have an ID. A check of the driver and passenger came back clear and was warned for speeding. After Deputy spoke with fellow Deputies it was learned by a phone that the passenger

was not Charles but Marquis Hampton. Marquis has active warrants. On 1/14/16 Marquis was identified on a surveillance camera at Walmart enter the back stock room and selected a TV then loaded the TV in a white vehicle. Marquis evaded law enforcement earlier in the week and finally located and placed under arrest.

To Get a Burning Permit:

Loudon (865) 986-8395
 Monroe (423) 442-7401
 Roane (865) 354-1054

Call 865-771-2249 to Advertise and start saving today!
 Has your group got an event coming up?
 Let us know!!!

Notice: The Daily Edition does not knowingly accept fraudulent or misleading materials. The Daily Edition cannot guarantee the validity of offerings or statements contained herein. All liability for the contents of all advertising, and for any claims that may arise therefrom, is the responsibility of the advertiser or its agency. The Daily Edition reserves the right to reject, edit, or abbreviate any advertisement submitted. Advertising is accepted with the understanding that all liability for all copyright violations is the sole responsibility of the advertiser. Photographs, artwork and other copy submitted for publication is considered the sole property of the advertiser. The Daily Edition will make every effort but will not be liable for failure to publish and ad or for typographical and layout errors. All statements and information about highlights featured items, letters to the editor, herein are those solely given to the interviewer or writer and the Daily Edition assumes no responsibility of the accuracy or validity thereof. The Daily Edition will gladly reprint at no charge that part of an advertisement in which an error occurs provided a claim is made within 3 days of the first publication of the ad. Information contained in the Wazzup is received anonymously and the Daily Edition assumes no responsibility for information and reserves the right to edit or reject any and/or all submissions. The Daily Edition is a daily newspaper of general circulation in Loudon County defined under TCA 2-1-104(a)(13). The Daily Edition also serves Monroe, Knox, Anderson, Roane and Blount counties and serves 30,000 readers weekly. Send mail to PO Box 1240, Lenoir City TN 37771. 865-771-2249. email: dan1204us@yahoo.com
 The Daily Edition is Loudon County's premier public interest and paid advertising paper. The Daily Edition is produced and published daily Monday through Friday and is circulated throughout Loudon County and parts of Monroe and Knox Counties. Display advertising rates \$5.00 per column inch and quantity discounts available. Call for information on upcoming promotions and events.



HACIENDA Ayala's
 Mexican Restaurant
 Market Dr. * Lenoir City (In Front of Food City)

Real Authentic Mexican Food at Affordable Prices

BEST
MARGARITA

You've Tried The Rest
 Now Come Have The Best!!!

We Accept ALL Competitors Coupons Outside of Mexico City!
 986-3553

Good Credit OK • Bad Credit OK • Bankruptcies OK • Repo OK



2010 Kia Soul Sporty, 4 cyl, Auto, PW, PL, A/C, Great On Gas, Like New



2010 Ford Escape Limited Leather, Alloy Wheels, Heat, A/C, Luggage Rack, 79K,

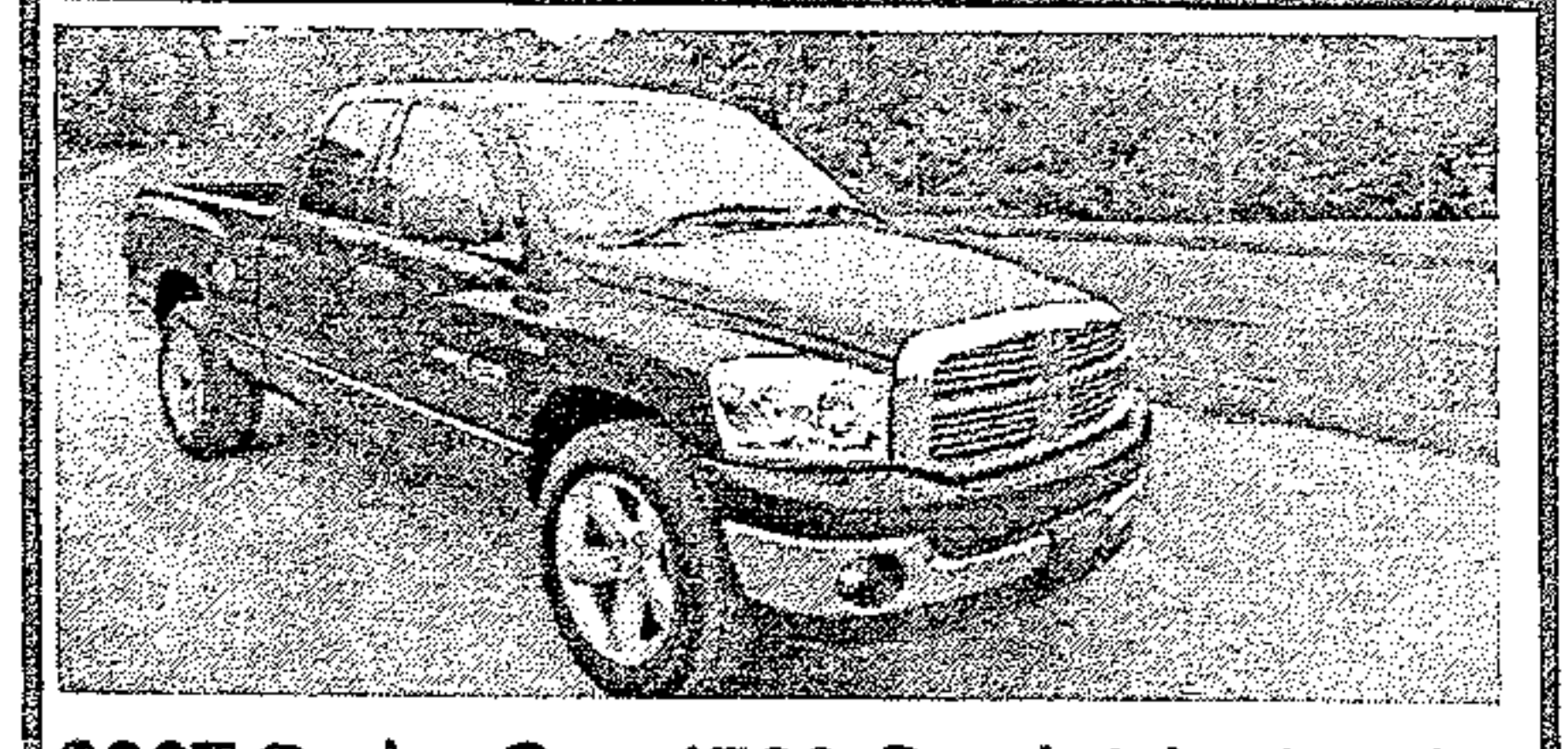

2007 Dodge Ram 1500 Quad Cab, Thunder Road PKG, 20 in. Wheels, Low Miles, Hemi



2008 Ford Explorer 84k, 3rd Row Seating, Luggage Rack, Tow Pkg, PW, PL



2011 Ford Ranger Low Miles, Tow Pkg, New Tires, A/C, Heat, Bed Liner.



2011 Dodge Grand Caravan DVD, Stow & Go, Loaded, Remote Doors, Rear A/C

DEPENDABLE MOTORS 986-9343

803 E. Broadway • Lenoir City

* WAC. See Dealer for details

Visit our website at: www.dependablemotorslc.com

Serving Loudon County for 20 Years

AG
 hensive review of the criminal justice system in order to identify reforms that would ensure federal laws are enforced more fairly and—in an era of reduced budgets—more efficiently. Five goals

were identified as a part of this review:

To ensure finite resources are devoted to the most important law enforcement priorities;

To promote fairer enforcement of the laws and alleviate disparate impacts of the criminal justice system;

To ensure just punishments for low-level, nonviolent offenders;

To bolster prevention and reentry efforts to deter crime and reduce recidivism; and,

To strengthen protections for vulnerable populations.

The Justice Department refers to this initiative as “Smart on Crime.” The U.S. Attorney’s Office for the Eastern District of Tennessee partnered with the Chief of the U.S. Probation Office

for the Eastern District of Tennessee, Tony Anderson, and his staff to implement the program locally. The local program focuses on ways to make the district safer by providing federal ex-offenders with the resources necessary to successfully re-enter the community and reduce recidivism. On Monday, Jan. 25, 2016, the local Smart on Crime Initiative started

with a Community Resource Expo in Chattanooga, Tenn. Anderson kicked off the inaugural event by addressing the ex-offenders during the expo. The expo included a partnership with or featured community service providers who include Behind the Bars, BlueCross BlueShield, Bureau of Alcohol, To-

(see AG ctd, pg. 7)

For Sale: oak Wood Mulch



Mushroom Compost Topsoil.



Firewood

Call Steve Spoon
 986-4282

West End Storage & Warehouses
 502 Ward Avenue • Loudon
 Call 865-458-4774 or 865-679-5555

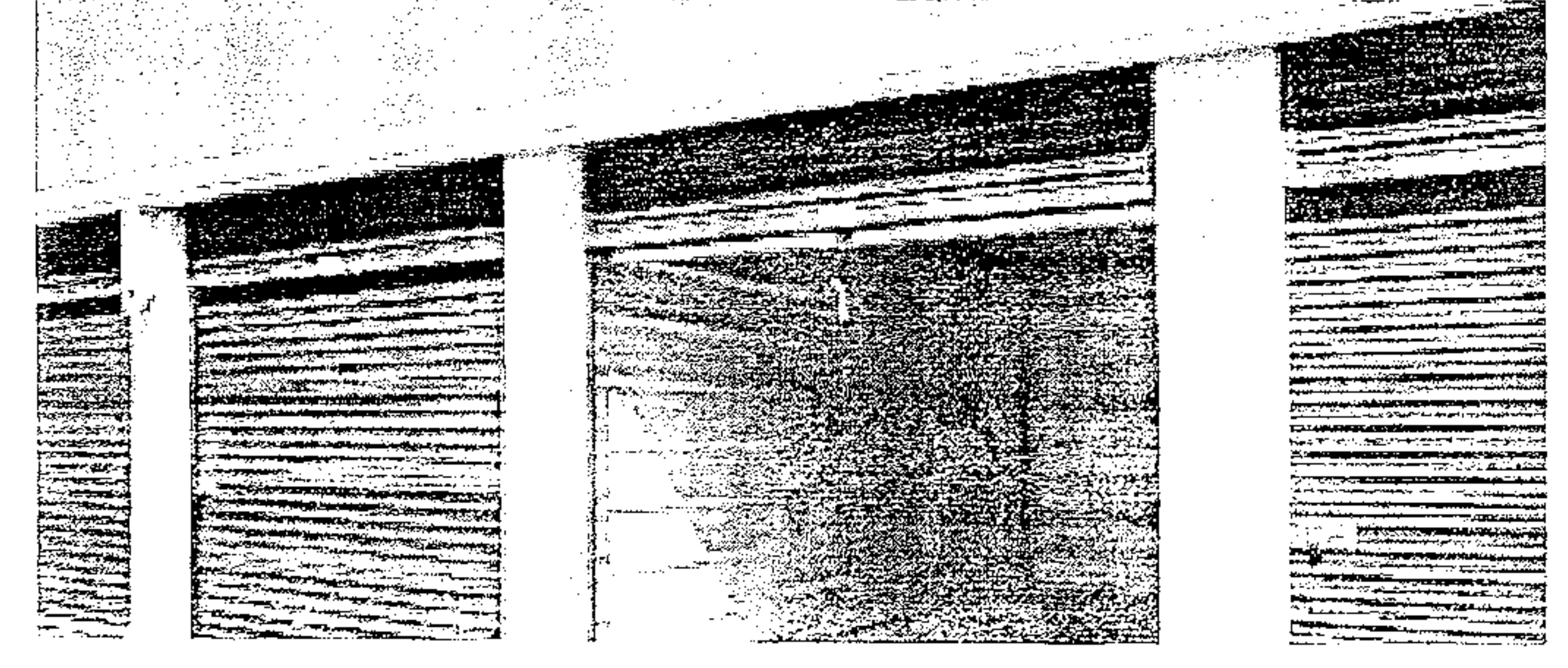

STAINED INK

TATTOO & PIERCING
 LENOIR CITY 865 816-6440
 NEW OWNER • NEW ARTIST • SINCE 2011
 521 Hwy 321 next to Vape & Stuff & Inn Of Lenoir!
 Clean-Affordable-Quality-Custom
 Tattoo's You've Always Wanted!

BRING IN THIS AD FOR **\$25 OFF!**
 NEW INK FOR NEW CUSTOMERS ONLY!

Check us out on FB.com/
 Stained.Inc.Tattoo/
 www.STAINEDINC.com



C&J Towing and Recovery

LOWEST TOWING RATES AROUND!!!

Have you been overcharged for any type of towing service in the Lenoir City area? If you have a breakdown or accident please OWNER REQUEST C&J Towing with the officer. Also please call your Sheriff and ask him to place C&J Towing on the “Rotation List*” and help other motorists save as much as you did! We at C&J are locally owned and operated, State approved, licensed, bonded and insured. Call and let us know if your denied service or how we can be of assistance.

*note: the “Rotation List” is a list of wrecker services that provide service for wrecks, DUI’s, breakdowns, etc. and are on an on-call basis for service. This list is approved by the Sheriff.

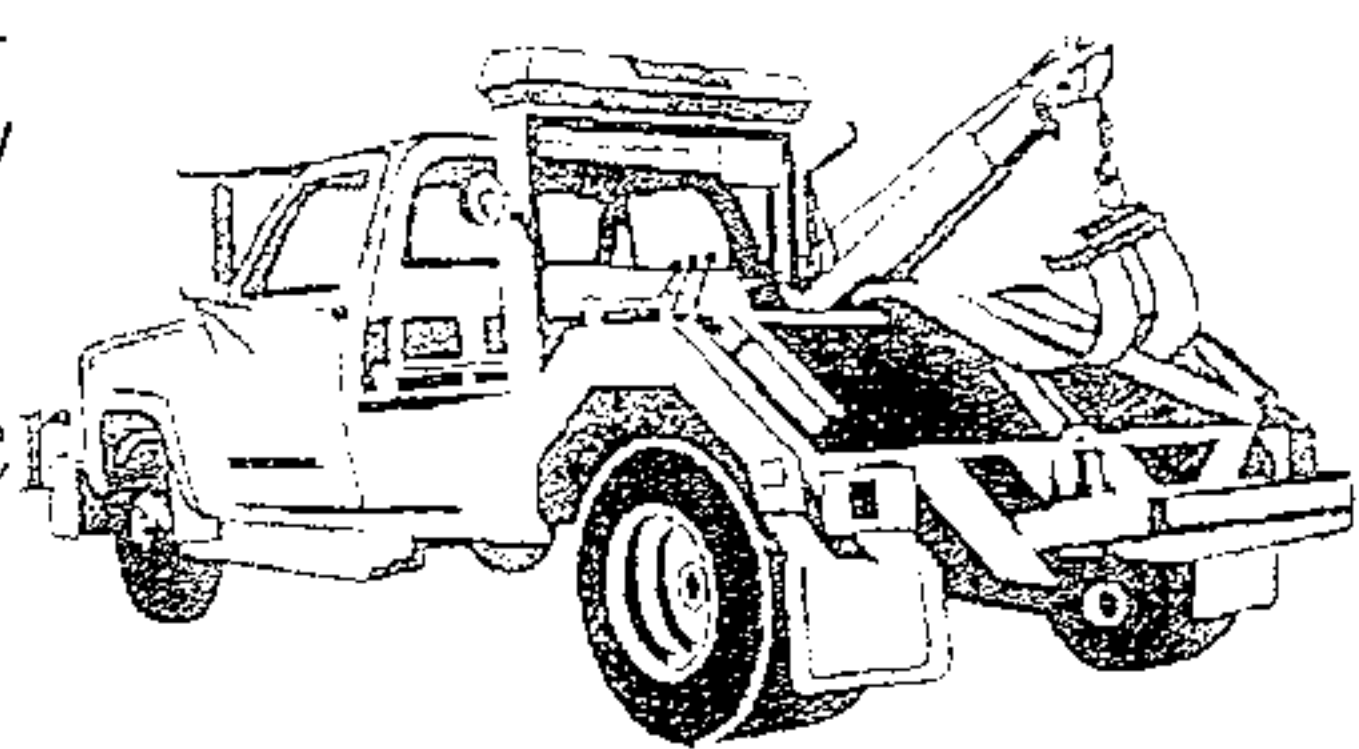
Cliff Teeters • Owner
 865-809-1661

BIMBO'S

Deli Open 24 Hours
 865-986-9643 Call Ins Welcome

Specials

Lg. Cold Sub, bag of chips and 16 oz. fountain drink
 only \$6.29

Footlong Corn Dog \$2.59

sentenced individual received shipments of marijuana from California, Hall often stored them at his farm in Mendota, Va. Hall also stipulated that he sold marijuana to a number of people, including his son, Michael Elbert Hall, 29, of Kingsport, who was previously convicted and

sentenced in federal court to serve 12 months and one day for a marijuana conspiracy charge. Hall acknowledged that the bulk of the marijuana attributed to his son came from him.

In April 2015, Hall was pulled over for a traffic stop in Kingsport. A search of his person and vehicle resulted in the seizure of

approximately \$32,496.00 in cash, over three pounds of marijuana and a loaded 9mm pistol. A search warrant was subsequently obtained for Hall's Kingsport residence, which resulted in the seizure of approximately 110 firearms, \$56,989.00 in cash, thousands of rounds of ammunition and over six more pounds of marijuana. Two

of the firearms were determined to be stolen.

Others who were previously sentenced in this conspiracy included: Morris Anthony Phillips, 39, and Antonio Barrington Parsley, 24, both of Culver City, Ca.; Glenn Draughn, 69, of Kingsport, Tenn.; Larry Thomas Williams, 68, of Mendota, Va.; and Kenny

Russell, 57, of Kingsport, Tenn., who were sentenced to 144 months, 46 months, 63 months, 140 months and 60 months in federal prison respectively.

Law enforcement agencies participating in this investigation include the Tennessee Bureau of Investigation, Internal Revenue Service - Criminal Investigation, Second District Judicial Drug Task Force, Kingsport Police Department, Russell County, Virginia Sheriff's Office and LA IMPACT (Los Angeles Interagency Police Apprehension Crime Task Force), which includes the Hawthorne, Hermosa Beach, Alhambra, Pomona, Inglewood and Culver City Police Departments. Assistant U.S. Attorney Wayne Taylor represented the United States.

DUI

Anthony Hood, 26, H Street Sweetwater, was charged with DUI. Officer Benny Houser LPD, was dispatched to the McDonald on Hwy 72 for an unconscious male in the parking lot.

Upon arrival Officer made contact with the driver identified as Anthony Hood, after numerous attempt Anthony finally rolled down the window and Deputy unlocked the vehicle.

Officer made contact with Anthony who had a strong odor of alcoholic beverage about his person. Anthony was ask to perform sobriety test which he did poorly on. Anthony was placed under arrest. Officer Benny Houser LPD, made the arrest.

PUBLIC NOTICE

Special-Called Purchasing Committee Meeting

The Lenoir City Purchasing Committee will be holding a special-called meeting at City Hall on Thursday, February 11, 2016 at 9:30 A.M. The purpose of the meeting will be to review and discuss the bids received in the previous Purchasing Committee Meeting.

Thank you.

Lenoir City Planning and Codes Department Public Notice

Public Hearing

The Lenoir City Mayor and City Council will hold a public hearing on Monday, February 22, 2016 at 6:55P.M. at Lenoir City Hall to consider final passage of the following ordinance:

AN ORDINANCE TO AMEND THE ZONING MAP OF THE CITY OF LENOIR CITY, TENNESSEE PURSUANT TO §13-7-204 OF THE TENNESSEE CODE ANNOTATED, TO REZONE PROPERTY LOCATED OFF HALL STREET FROM R-1-S SINGLE FAMILY RESIDENTIAL DISTRICT AND C-3 HIGHWAY COMMERCIAL DISTRICT TO R-2 MEDIUM DENSITY RESIDENTIAL DISTRICT.

A copy of the proposed ordinance is available for review at the Lenoir City Office of Codes Enforcement and Planning, 600 E. Broadway, Lenoir City, TN, or you may call 865-986-7224 during business hours for assistance.

How about \$50 you didn't have before?

Just come to Liberty Tax, let us do your taxes and we'll hand you \$50 cash on the spot.

119 E. Broadway Street
Downtown Hwy 11
820 Hwy 321 N

Across from Burger King

Lenoir City, TN 37771
865-986-8335



with paid tax preparation. Valid at participating locations. Cannot be comined with other offers or used toward past services. One coupon per return. Expires 2-15-15

BUDGET Transmissions

302 S. Northshore Drive Knoxville

(865) 584-4391 budget-transmissions.com



Why Buy From Budget?

- Free Towing From Lenoir City or Loudon County
- 20 Years of BBB Zero Customer Complaints Award Member
- A+ Plus Rated
- Huge Transmission Inventory
- Best Technicians Period!!!

Call (865) 584-4391 Today!

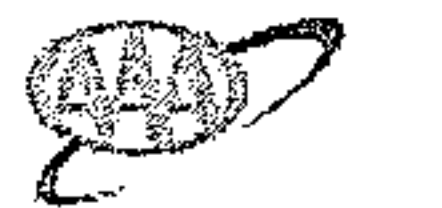

Approved Auto Repair



APPLY FOR AN EASY ADVANCE AND GET MONEY FAST!

\$750 Easy Advance at Liberty Tax at No Additional Cost!

820 Hwy 321 N 119 E. Broadway Street
Across from Burger King Downtown Hwy 11

Lenoir City, TN 37771
865-986-8335

An Easy Advance (EA) is a \$750 loan secured by your tax refund and is offered by Republic Bank & Trust Company, member FDIC, to qualifying applicants. There are no fees or interest associated with the EA. Subject to approval. Visit your Liberty office to learn more. Officer Expires 2-28-15.



Documentary never-ending pursuit of the original or ultimate high, features stark first-person accounts told by individuals who have abused opioids or whose children have abused opioids, with tragic consequences.

"This film may be difficult to watch," explains FBI Director James Comey, "but we hope it educates our students and young adults about the tragic conse-

quences that come with abusing these drugs and that it will cause people to think twice before becoming its next victim."

And according to Acting DEA Administrator Chuck Rosenberg, "The numbers are appalling—tens of thousands of Americans will die this year from drug-related deaths, and more than half of these deaths are from heroin and prescrip-

tion opioid overdoses. I hope this [documentary] will be a wakeup call for folks."

The individuals featured in the film—a few of whom are highlighted below—chose to tell their stories to help stop others from going down the same destructive path.

Katrina, a former business executive and mother who became addicted to opiates after self-medicating

with pain pills and alcohol and whose own daughter died of a drug overdose. "You can't go back and say, 'I'm sorry,' or set a better example, or talk 'em out of it," she says. And of her own addiction, she explains, "The spiral down is so fast... and I lost everything. I lost my daughter first and foremost. So all the work I did, all those dreams I had, it's like I'm starting over again

with a huge weight on my shoulder...all for a pill."

Matt, who began using marijuana at age 11 and became addicted to opiates at age 15. "In the beginning," he explains, "I would always try to get pills because you know what you're getting. Eventually, that just got too expensive...so then you'd go for heroin because it's cheaper."

Trish, whose daughter Cierra—an honor roll student at her high school—died after a heroin overdose. "Cierra did not take life for granted until she started using," says her mother. "It is much stronger than you, and it will win." Noting the broader impact of addiction, Trish adds, "It affects everyone in your family for the rest of their life...we're the ones stuck missing you."

Chasing the Dragon also features interviews with medical and law enforcement professionals discussing a variety of issues, including how quickly addiction can set in, how the increasing costs of prescription opioids can lead to the use of heroin as a less expensive alternative, the horrors of withdrawal, the ties between addiction and crime, and the fact that, contrary to popular belief, opiate abuse is prevalent in all segments of society.

The documentary is available on this website for viewing or downloading. Copies can also be obtained by contacting your local FBI or DEA field office.

PURDY'S AUTO PARTS AND SALVAGE

WE BUY SCRAP IRON • COPPER • BRASS • ALUMINUM

\$

Paying Top \$\$\$

Call For Latest Prices

You Name It, We Buy It!

Radiators, Wheels, Batteries, Appliances, Farm Equipment

Copper

Paying Top \$\$\$

Call For Latest Prices

You Call We Haul!

423-519-5402

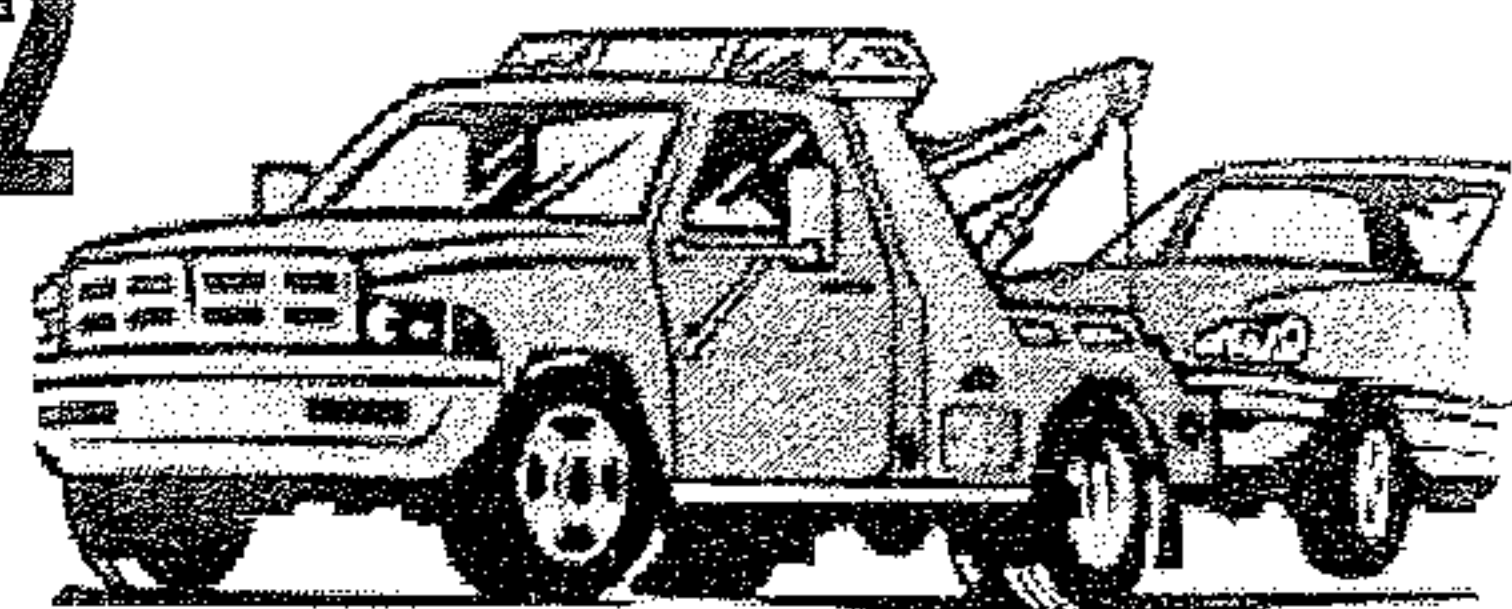

* Prices subject to change with the market.

423 337-3977

149 County Road 323 Sweetwater

Complete Cars

per 100 lbs.

Scrap Metal

Paying Top \$\$\$

Call For Latest Prices

per 100 lb

We Buy Batteries

Aluminum Cans

Paying Top \$\$\$

Call For Latest Prices

**Now Selling
Aftermarket
Body Parts at
Discount Prices**

* Prices subject to change with the market.

DV

Jared Anthony Coatney, 26, Finley Drive, Lenoir City, was charged with driving under the influence and driving on suspended.

The passenger, Stephanie Rutledge, 25, Finley Drive Lenoir City, was charged with PI.

Deputy Kenneth Palmer LCSO, was dispatched to a reckless driver on Interstate 75 south near the 81 mm. Dispatch advised it was a white vehicle getting off at the 81 exit. Deputy made contact with the vehicle, and observe it cross the fog line several times, and weaving inside the lanes.

Deputy made a traffic stop on the vehicle and made contact with the driver Jared Coatney, who appeared to be under the influence and the passenger Stephanie Rutledge passed out. Jared had slurred speech and talking very slowly. Jared did poorly on sobriety test and was placed under arrest. The passenger Stephanie fell asleep several times during the traffic stop and was placed under arrest. Deputy Kenneth Palmer LCSO, made the arrest.

AG ctd. from pg. 3

bacco, Firearms, and Explosives, Bureau of Prisons Half-Way House, Chattanooga

Community Kitchen, Chattanooga State Community College, Christian Women's Job Corp, Father to the Fatherless, Johnson Mental Health, Marion County, Tennessee Jail Chaplain, Mt. Canaan Baptist Church, Northside Neighborhood House, Olivet Church, Salvation Army, Stephens Table, Tennessee Career Center, Tennessee Department of Human Services, Tennessee Department of Labor and Workforce Development Career Center, and the United Way 2-11. Through this network of federal law enforcement officials and community service providers, the

Smart on Crime Initiative is working to make this community safer through being both smart and tough on crime. TechTown, a technology and entrepreneurial learning center, provided space for the event and

Southern Star, a local Chattanooga-based restaurant, donated full-catering services for the event. Similar events are scheduled for Knoxville and Johnson City, Tennessee this week.

JOB OPENING

Loudon County Habitat for Humanity Home Store has an opening for an Associate. This 30-hour a week position provides services related to the pickup of donated goods outside the store, and the movement of donations in the store. Assists with scheduling, determining routes, and driving the store truck. Must be able to lift 50 pounds and be able to read a map and follow directions. Must have a valid driver's license. Must be adaptable to rapidly changing conditions and have good interpersonal skills. Applications available at the store T-F 9:00-5:00 and Sat. 8:00-1:00. 303 Simpson Road East, Lenoir City. Drug Free Workplace - EOE

LOOK! \$75 Weekly Payments LOOK!

MARTY'S AUTO SALES • 986-2222 • MARTY'S AUTO SALES • 986-2222 • MARTY'S AUTO SALES • 986-2222 • MARTY'S AUTO SALES • 986-2222 • MARTY'S AUTO SALES • 986-2222

Bad Credit

Divorce

Fixed Income

Repos

Bankruptcy

No Credit

APPROVED!

Visit Us On The Web At:
martysautosales.net

NO

CREDIT

CHECKS

\$499 down*

07 Cobalt, 5spd, gas saver, runs great Only \$499 down *

\$299 down*

99 Solara, V6, auto, sporty, Only \$299 down *

\$599 down*

04 Santa Fe, auto, Nice, clean. Only \$599 down *

\$499 down*

01 Sebring 2dr. sporty, Only \$499 down *

\$499 down*

05 Sedona, Runs Great, Only \$499 down *

\$399 down*

01 Rodeo, 4cyl, 5spd, Gas Saver Only \$399 down *

\$499 down*

99 Grand Cherokee, Loaded, lthr. Only \$499 down *

\$99 down*

98 Bonneville, 6 cyl, Auto, low payments only \$99 down *

NO

Credit Checks

Marty's Auto Sales

986-2222

*See Dealer for details. All down payments plus tax, tag, title and fees.

100%

Approval*

MARTY'S AUTO SALES • 986-2222 • MARTY'S AUTO SALES • 986-2222 • MARTY'S AUTO SALES • 986-2222 • MARTY'S AUTO SALES • 986-2222 • MARTY'S AUTO SALES • 986-2222

Obits conc. from pg. 6

J.) Walker; daughters, Tonya, April and Kimberly; mother, Dorthy Walker; sister, Donna; brother, Tommy Walker; several nieces and nephews; brothers-in-law and sisters-in-law, Earnest Jr. and Tammy Stevens, Tommy Skidmore and Reese; special friend,

Kevin Jones. The family will receive friends from 2 to 4 p.m. Sunday, February 7th at Click Funeral Home in Lenoir City. Funeral services will follow at 4 p.m. with Rev. Earnest Stevens officiating. A private interment will be held. Click Funeral Home, 109 Walnut Street, Lenoir City is in charge of arrangements.

THE RELIC SHOP

521 Hwy 321 Lenoir City Suite 3
next to Stained Inc and the Inn of Lenoir
865-250-9280

WE ARE IN TUCSON, ARIZONA BUYING UP FOSSILS FOR THE SHOP. WE NEED TO MAKE ROOM!!!

ALL AMETHYST 40% OFF

GREAT SELECTION OF ANCIENT MEGALADON SHARK TOOTH OVER 8 MILLION YEARS OLD

Is Your Washer Broken?

Call Me

I Only Charge \$100 Period!!!

Call Allen

865-617-7113

A Name You Already Know And Trust Just Got Even More Dependable
DEPENDABLE AUTO SERVICE, LUBE AND TIRES
is Now Offering
Expert, Affordable Transmission Service

All ASE Certified Technicians

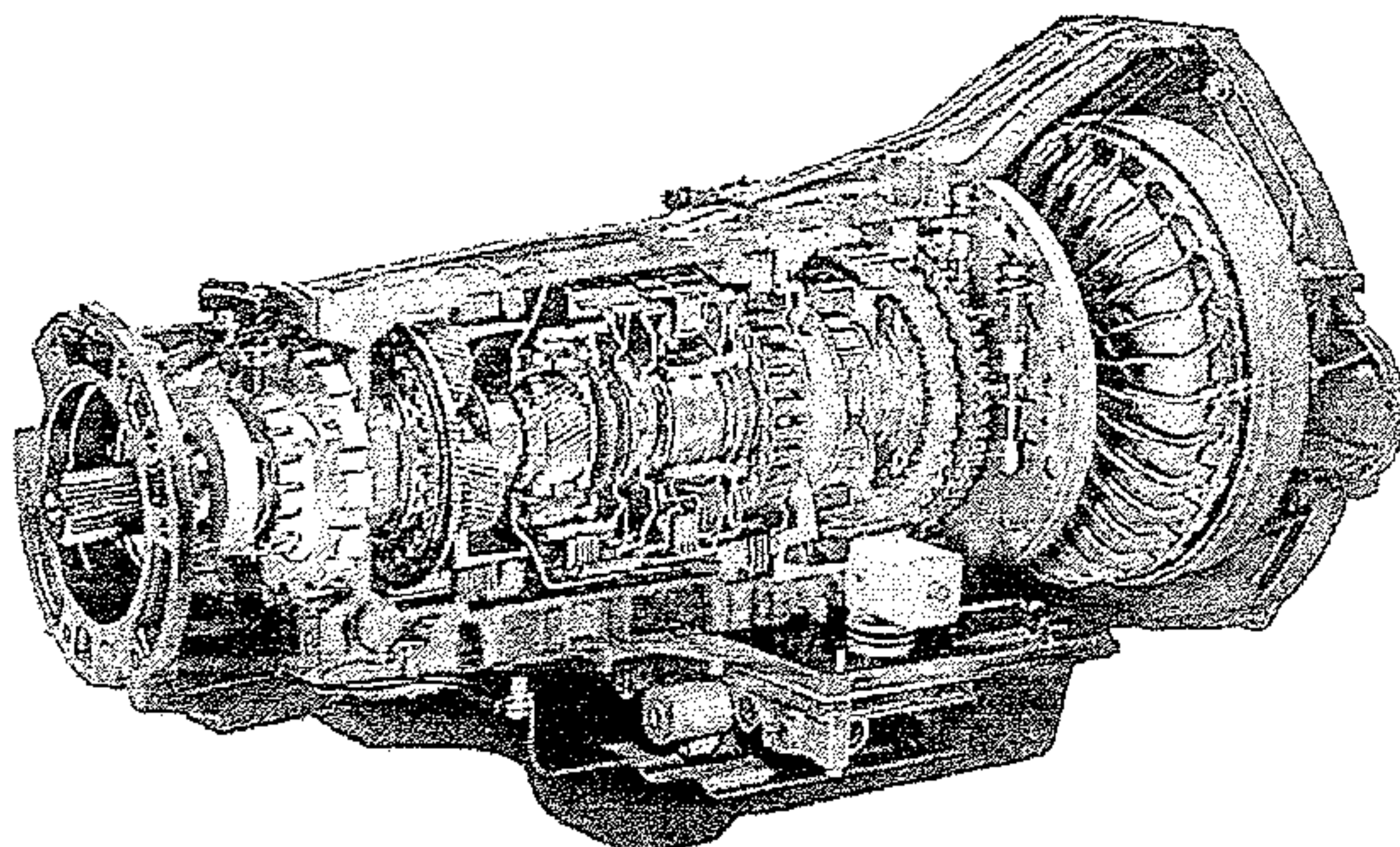

We proudly welcome all New Customers and Former Advanced Transmission Customers with a 10% Discount and Any Transmission Service or Repair*

865-986-9359

865-986-5050

Bad Credit, No Credit OK!!! We Finance Everybody!!!

Taxes Done Here!!! Bring your last pay stub or W2 and DRIVE TODAY!!!

Over 100 Cars, Trucks & Vans in Stock - Warranties On ALL Vehicles Sold!!!

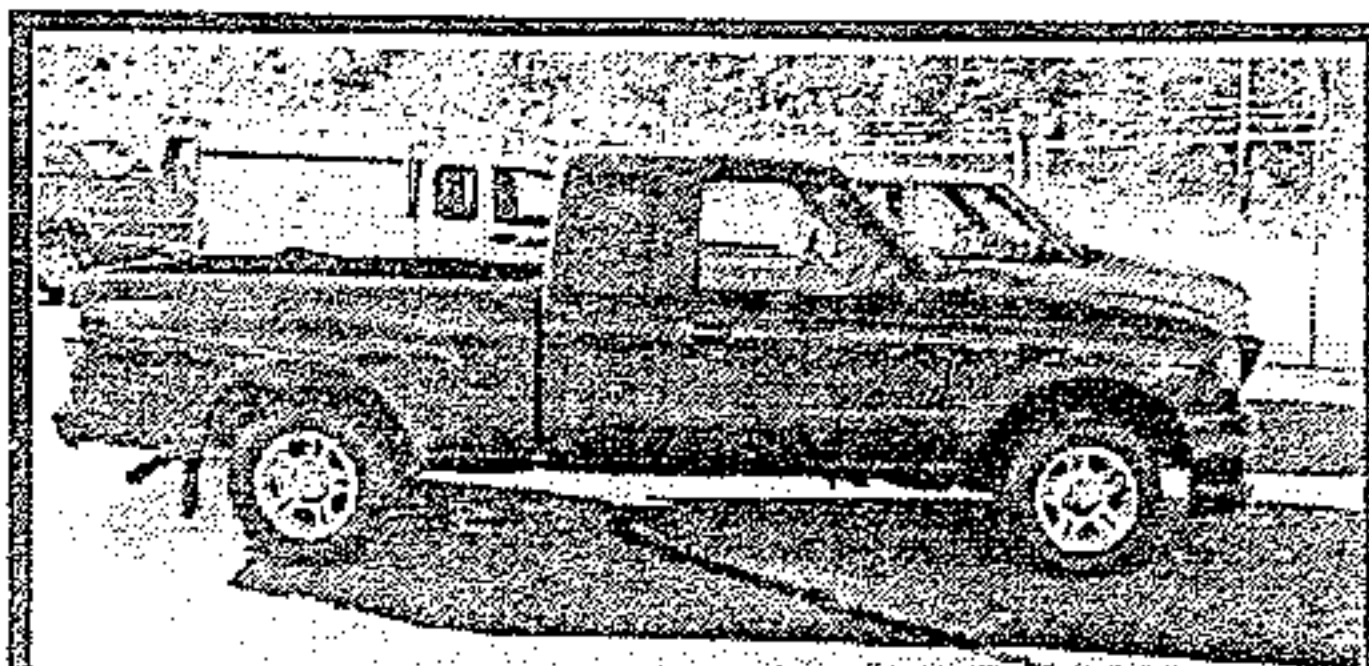

2005 Ford Ranger, Super Nice Truck, Very Low Miles

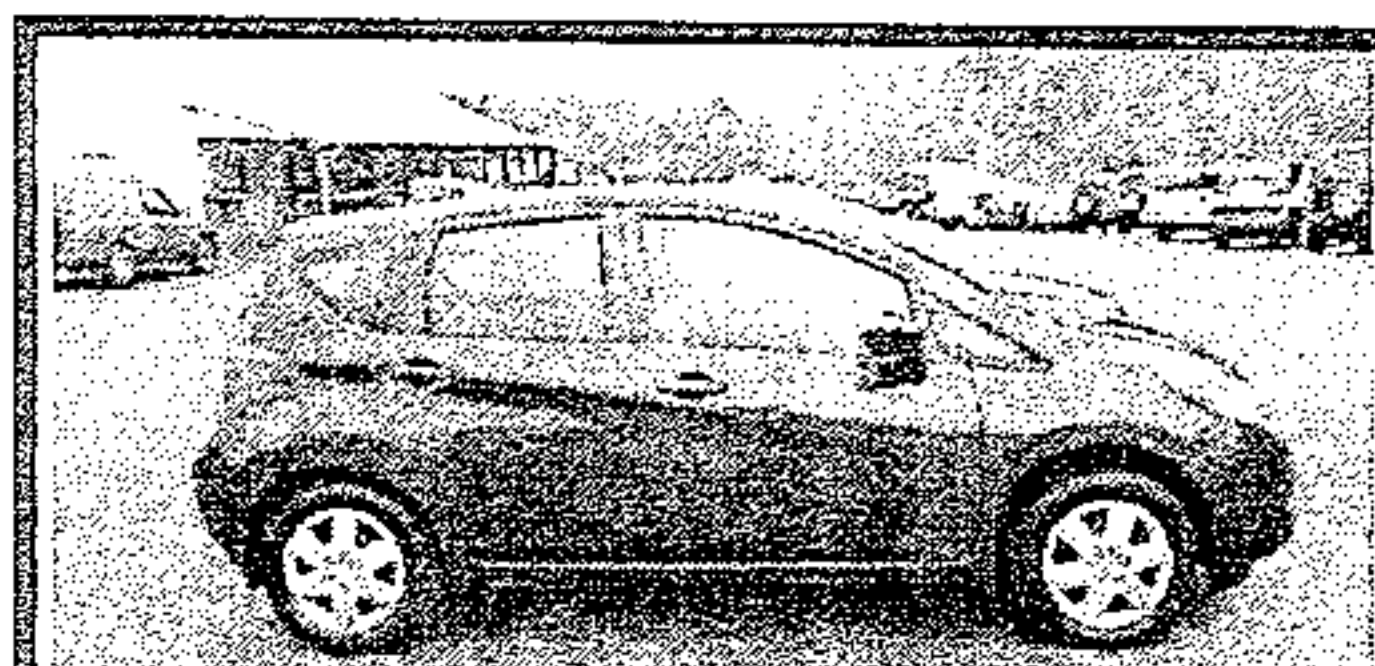

2015 Nissan Versa Note, Factory Warranty, Low Miles

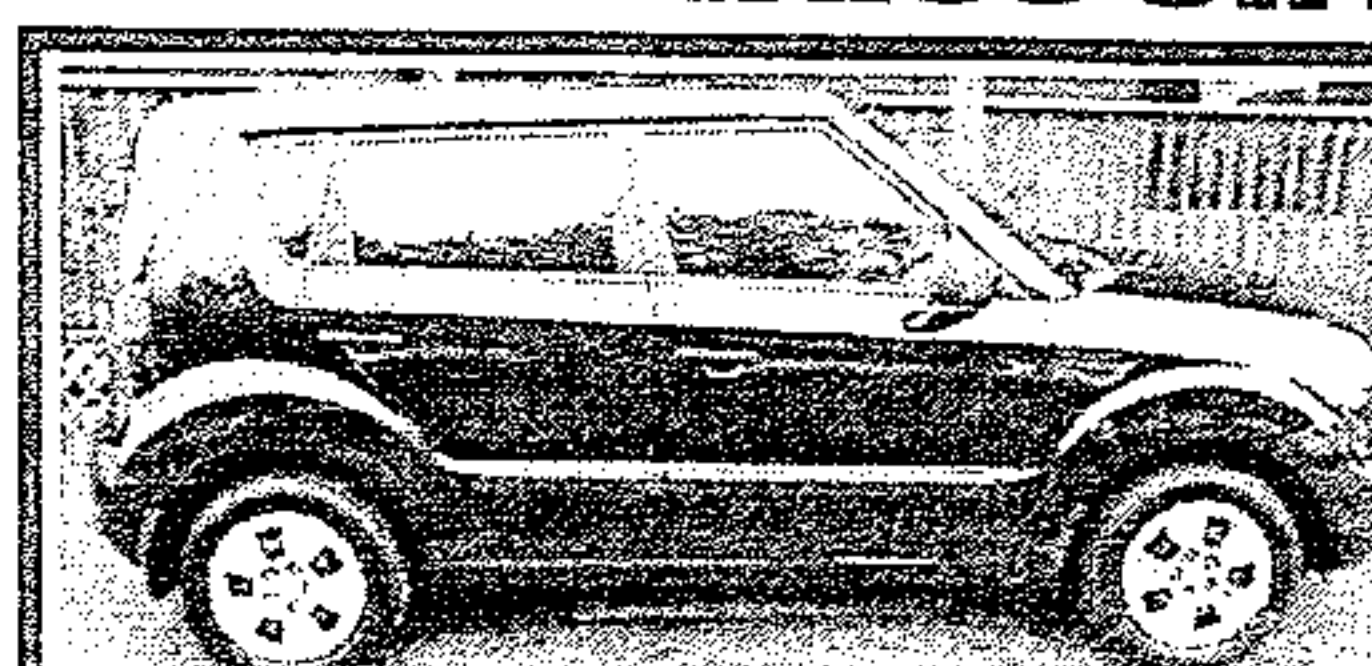

2011 Kia Soul, 5 speed, 4 dr, Gas Saver, Nice & Clean



2007 Chevy Equinox, 4dr, Extra Clean, lots of room

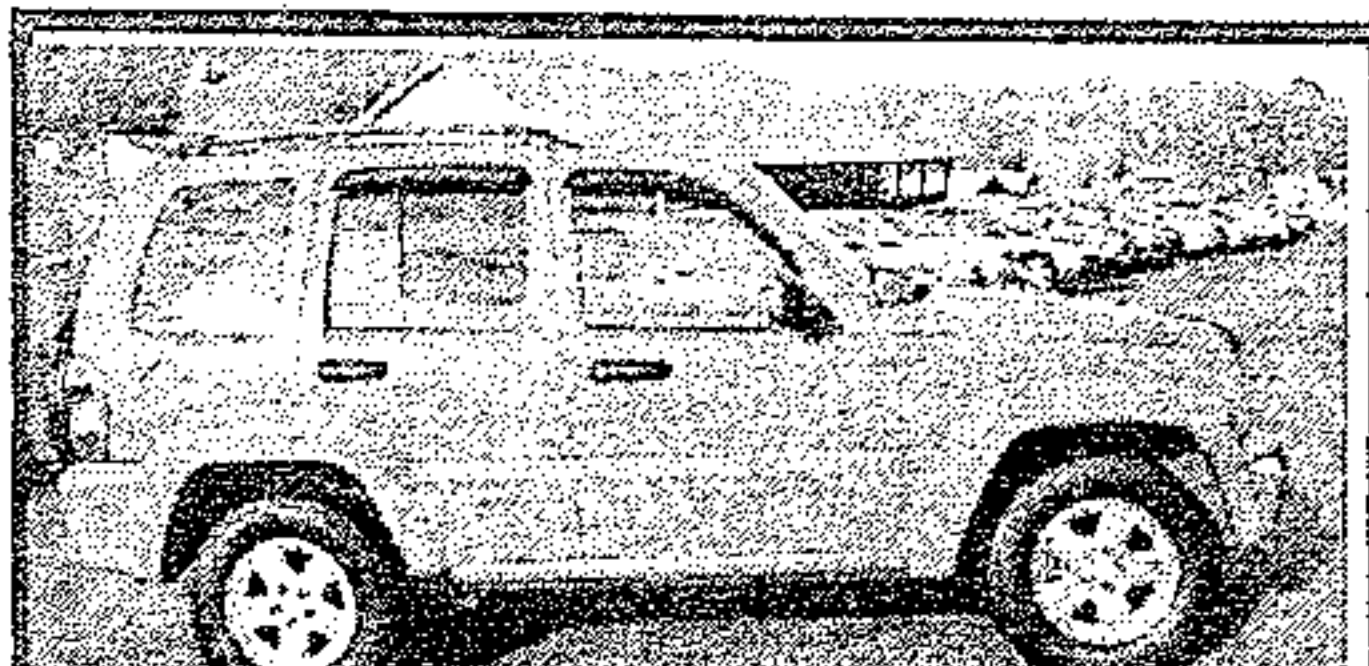

2004 Jeep Liberty, 77k miles, Leather, LOADED!!!

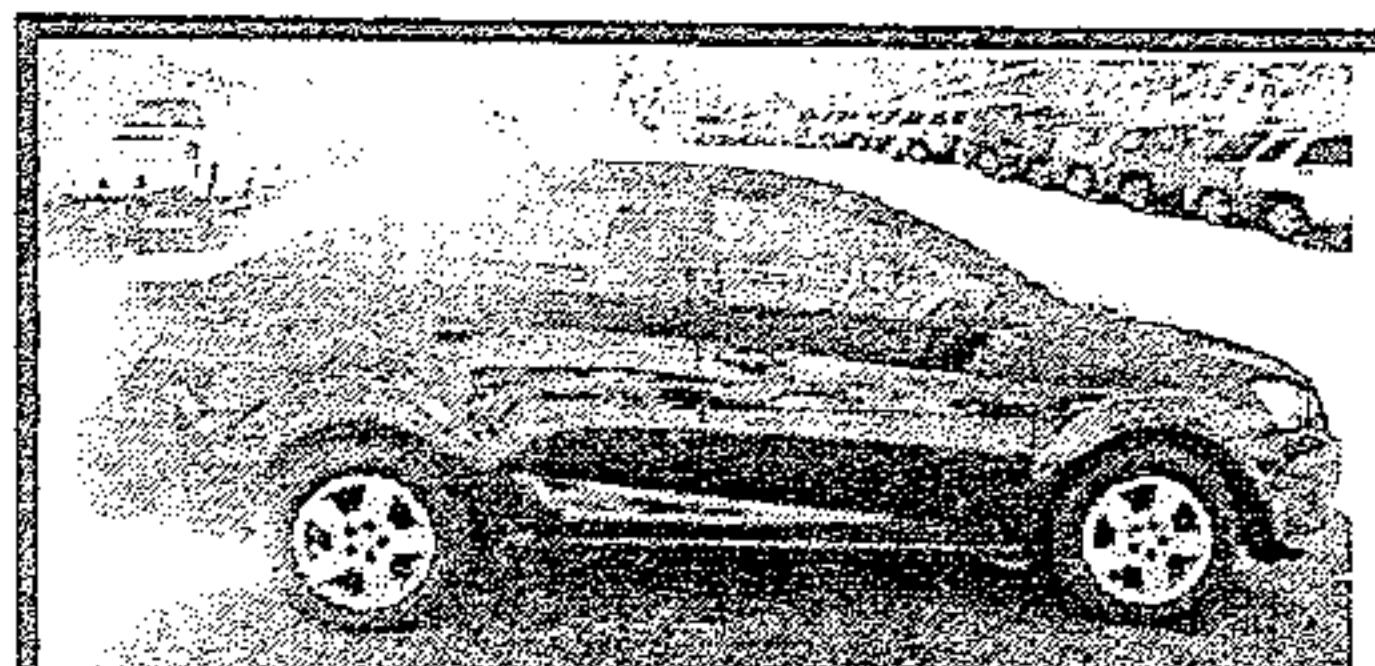

2014 Chevy Sonic, Factory Warranty, Low Miles!

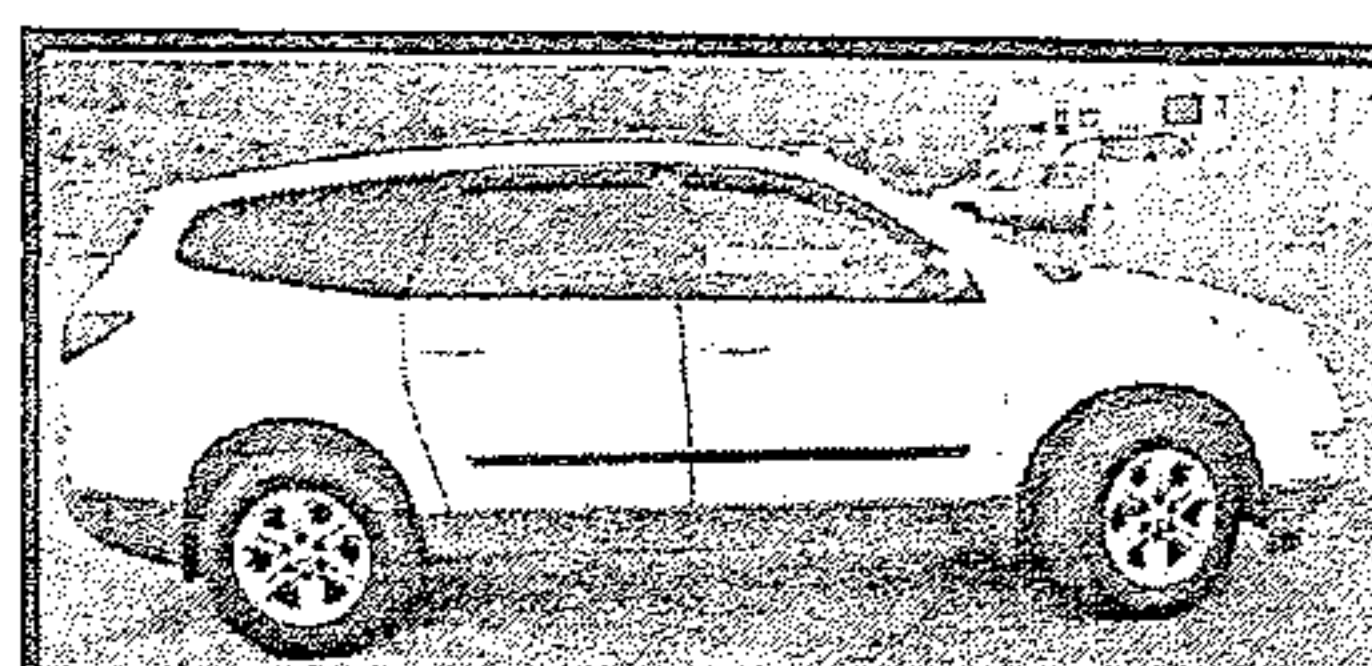

2010 Chevy Traverse, 3rd row seat, Loaded, Clean

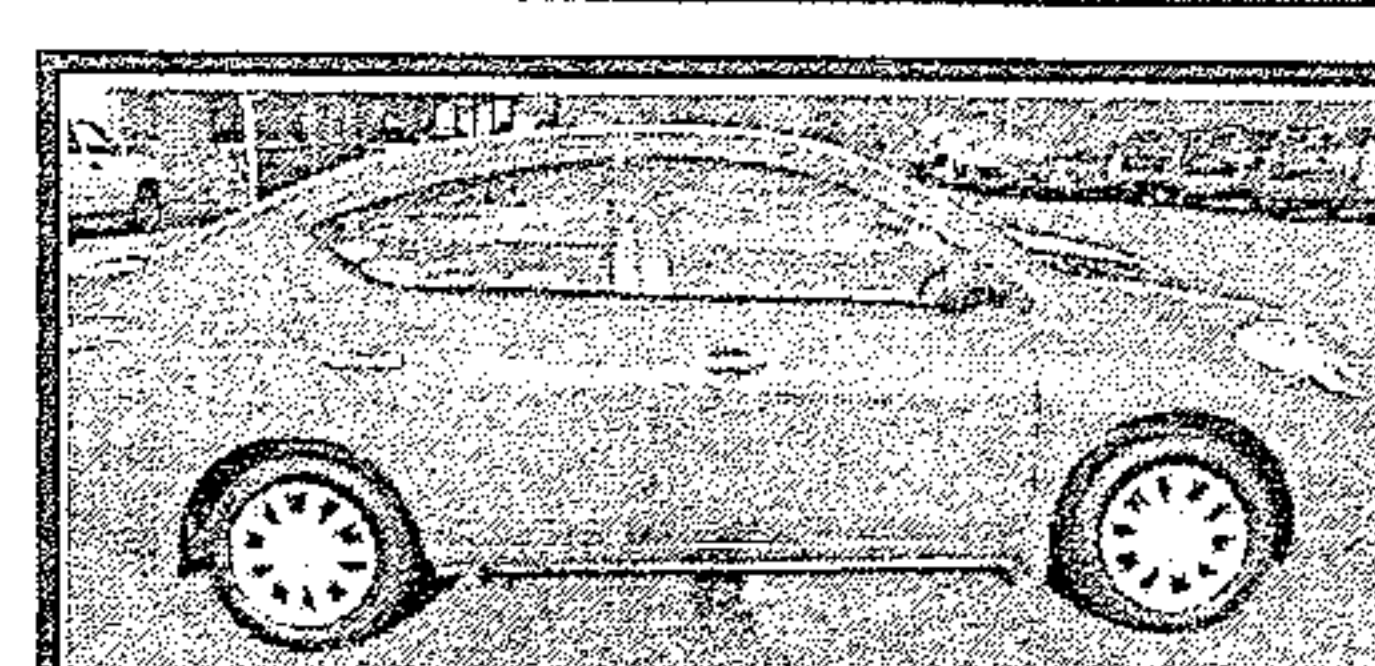

2013 Nissan Versa, Like New! LOADED!!!

WALT WILLIAMS, INC.

*with approved credit

3003 Highway 11 Lenoir City, TN 865-986-1111