

The Daily Edition

50¢

Serving Loudon, Monroe and Surrounding Counties

Friday, February 5, 2016

Trio charged following LCSO traffic stop; meth and more found



Bradley Brooks

(see trio pg. 2)



Roseanna Forsythe



Marcus Branyon

Tracking Animal Cruelty

FBI Collecting Data on Crimes Against Animals



A first look at the FBI's animal cruelty statistics will be available next year, but it will take three to five years for the data to begin showing helpful patterns. (see FBI pg. 5)

Victim hit with closed fist by assailant



(see DV pg. 7) Kenneth Smith

Randall Scott Braddock sentenced to 192 months for leadership role in A-PVP trafficking and international money laundering conspiracies

Randall Scott Braddock, 50, of Hendersonville, N.C., was sentenced on Jan. 27, 2016, by the Honorable Pamela L. Reeves, U.S. District Court Judge, to serve 192 months in federal prison for his leadership role in an extensive a-PVP (alpha-pyrrolidinopentiphenone)

(see A-PVP pg. 5)

Man sentenced to 7 years in federal prison for child pornography

Jason Collins, 37, of Soddy Daisy, Tenn., was sentenced by the Honorable Harry S. Matice, U.S. District Judge, to serve 85 months in prison, followed by a 15-year term of supervised release. Collins pleaded guilty in August 2015, to receipt of child pornography.

Restitution was also ordered to some of his victims.

The indictment and subsequent conviction of Collins was the result of a year-long investigation conducted by the Federal Bureau of Investigation (FBI), Bradley County Sheriff's Department, and Harriman Police Department. The investigation began when a Harriman Police detective was able to download images and videos from a Peer-to-Peer internet account be-

Best-Selling Author Erik Larson to Speak in Knoxville

Erik Larson, widely acclaimed master of page-turning nonfiction sagas, will speak in Knoxville at

the Bijou Theatre on Tuesday, March 22, at 7 p.m. This special author event is (see library pg. 3)

Verse of the Day

Once you were alienated from God ... but now he has reconciled you by Christ's physical body through death to present you holy in his sight, without blemish and free from accusation. — Co-

lossians 1:22

Obituaries

see inside **Wazzup**

A Super Duper Happy Birthday to Miss Becky from Madisonville! Yall that know

her make sure you wish her a happy birthday!

Weather

Today: Mainly sunny. High 47F.

Tonight: Partly cloudy. Low 28F.

Saturday Intervals of clouds and sunshine. High 51F.

Saturday Night Some clouds

early will give way to generally clear conditions overnight. Low 29F.

Sunday Plentiful sunshine. High 54F.

Sunday Night Mostly clear in the evening. Increasing clouds with showers after midnight. Snow may mix in

(Continued on page 6)

(see sentenced pg. 4)



3 08805 93489 2

Public Notice

The Lenoir City Council Meeting scheduled for Monday, February 8, 2016 has been cancelled. The next scheduled City Council Meeting will be held on Monday, February 22, 2016 at 7:00 P.M.

Thank you.

trio

Bradley Brooks, 33, Williams Ferry Road Lenoir City, was charged with Legend Drugs, and Man/Sell/Poss of Controlled Substance.

Marcus Branyon, 30, Kelly Lane Lenoir City, was

charged with Poss. of Drug Para.

Roseanna Forsythe, 32, Gateway Lane Philadelphia, was charged with Man/Sel/Poss. of Controlled Substance x2, Poss. of Drug Para, and

(see trio ctd. pg. 3)

Notice: The Daily Edition does not knowingly accept fraudulent or misleading materials. The Daily Edition cannot guarantee the validity of offerings or statements contained herein. All liability for the contents of all advertising, and for any claims that may arise therefrom, is the responsibility of the advertiser or its agency. The Daily Edition reserves the right to reject, edit, or abbreviate any advertisement submitted. Advertising is accepted with the understanding that all liability for all copyright violations is the sole responsibility of the advertiser. Photographs, artwork and other copy submitted for publication is considered the sole property of the advertiser. The Daily Edition will make every effort but will not be liable for failure to publish and ad or for typographical and layout errors. All statements and information about highlights featured items, letters to the editor, herein are those solely given to the interviewer or writer and the Daily Edition assumes no responsibility of the accuracy or validity thereof. The Daily Edition will gladly reprint at no charge that part of an advertisement in which an error occurs provided a claim is made within 3 days of the first publication of the ad. Information contained in the Wazzup is received anonymously and the Daily Edition assumes no responsibility for information and reserves the right to edit or reject any and/or all submissions. The Daily Edition is a daily newspaper of general circulation in Loudon County defined under TCA 2-1-104(a)(13). The Daily Edition also serves Monroe, Knox, Anderson, Roane and Blount counties and serves 30,000 readers weekly. Send mail to PO Box 1240, Lenoir City TN 37771. 865-771-2249. email: dan1204us@yahoo.com

The Daily Edition is Loudon County's premier public interest and paid advertising paper. The Daily Edition is produced and published daily Monday through Friday and is circulated throughout Loudon County and parts of Monroe and Knox Counties. Display advertising rates \$5.00 per column inch and quantity discounts available. Call for information on upcoming promotions and events.

HACIENDA Ayala's

Mexican Restaurant

Market Dr. * Lenoir City (In Front of Food City)

Real Authentic Mexican Food at Affordable Prices

BEST

You've Tried The Rest Now Come Have The Best!!!

MARGARITA

We Accept ALL Competitors Coupons Outside of Mexico City!

986-3553

Good Credit OK • Bad Credit OK • Bankruptcies OK • Repo OK

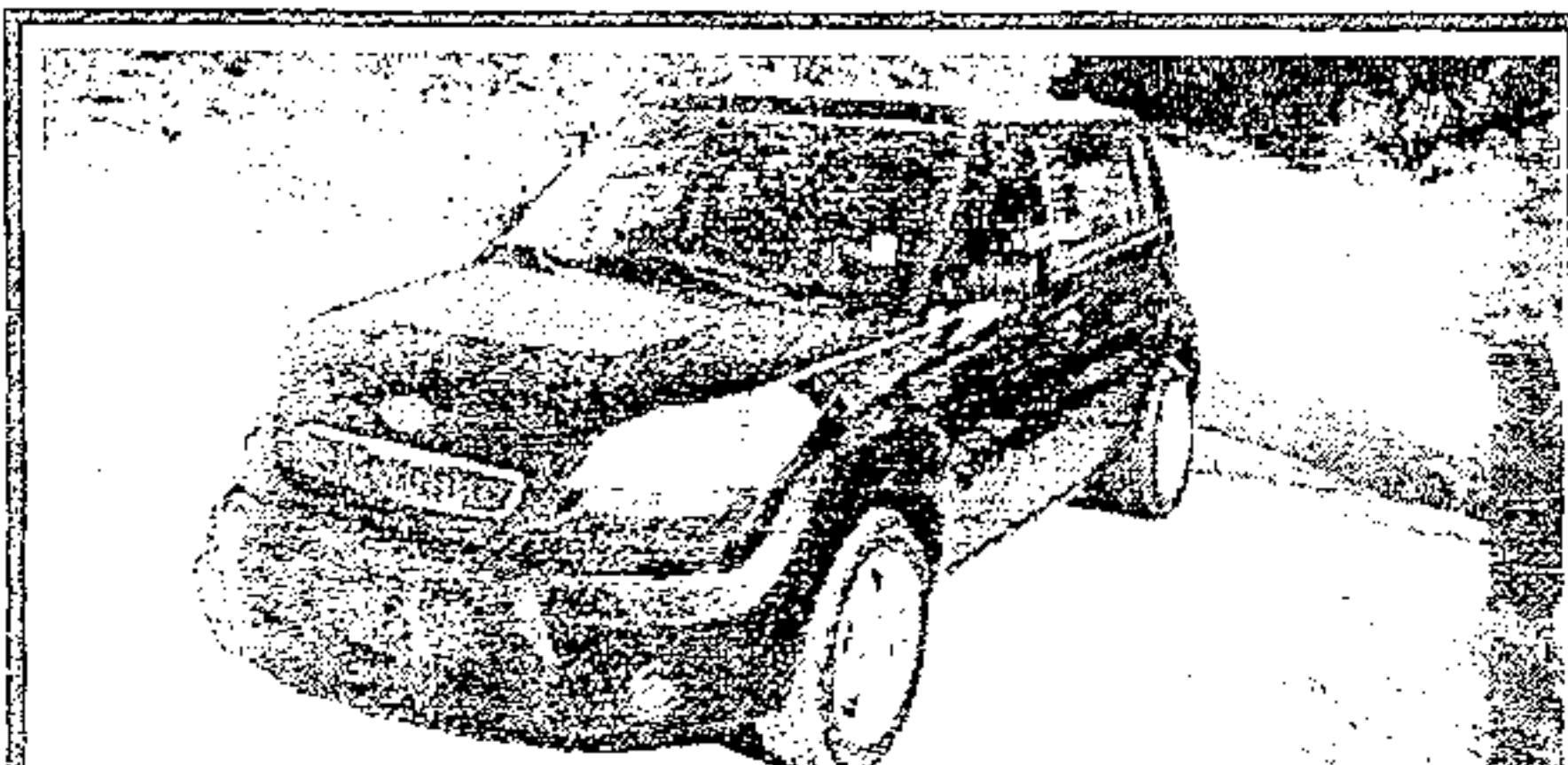

2010 Kia Soul Sporty, 4 cyl, Auto, PW, PL, A/C, Great On Gas, Like New

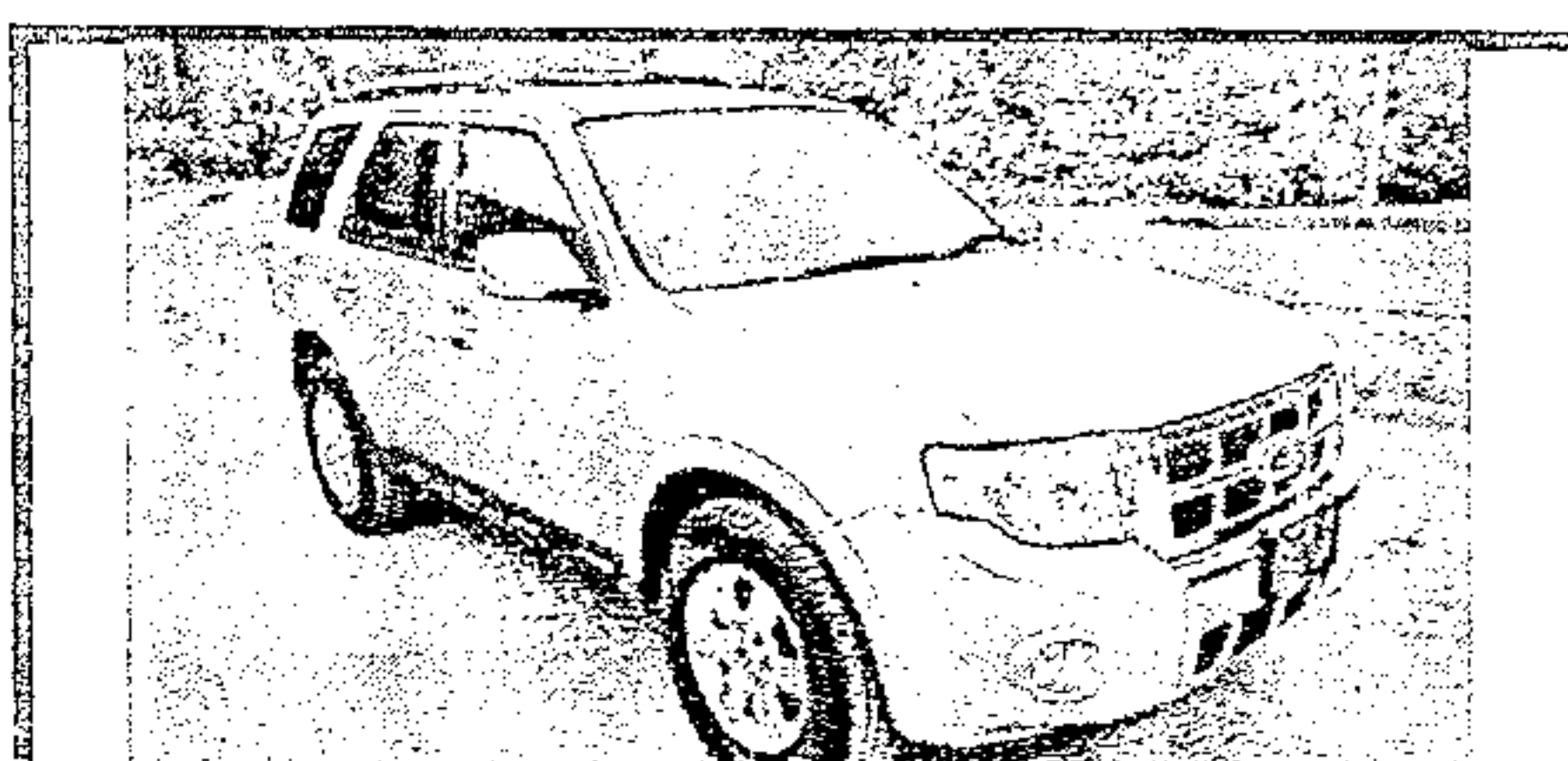

2010 Ford Escape Limited Leather, Alloy Wheels, Heat, A/C, Luggage Rack, 79K,

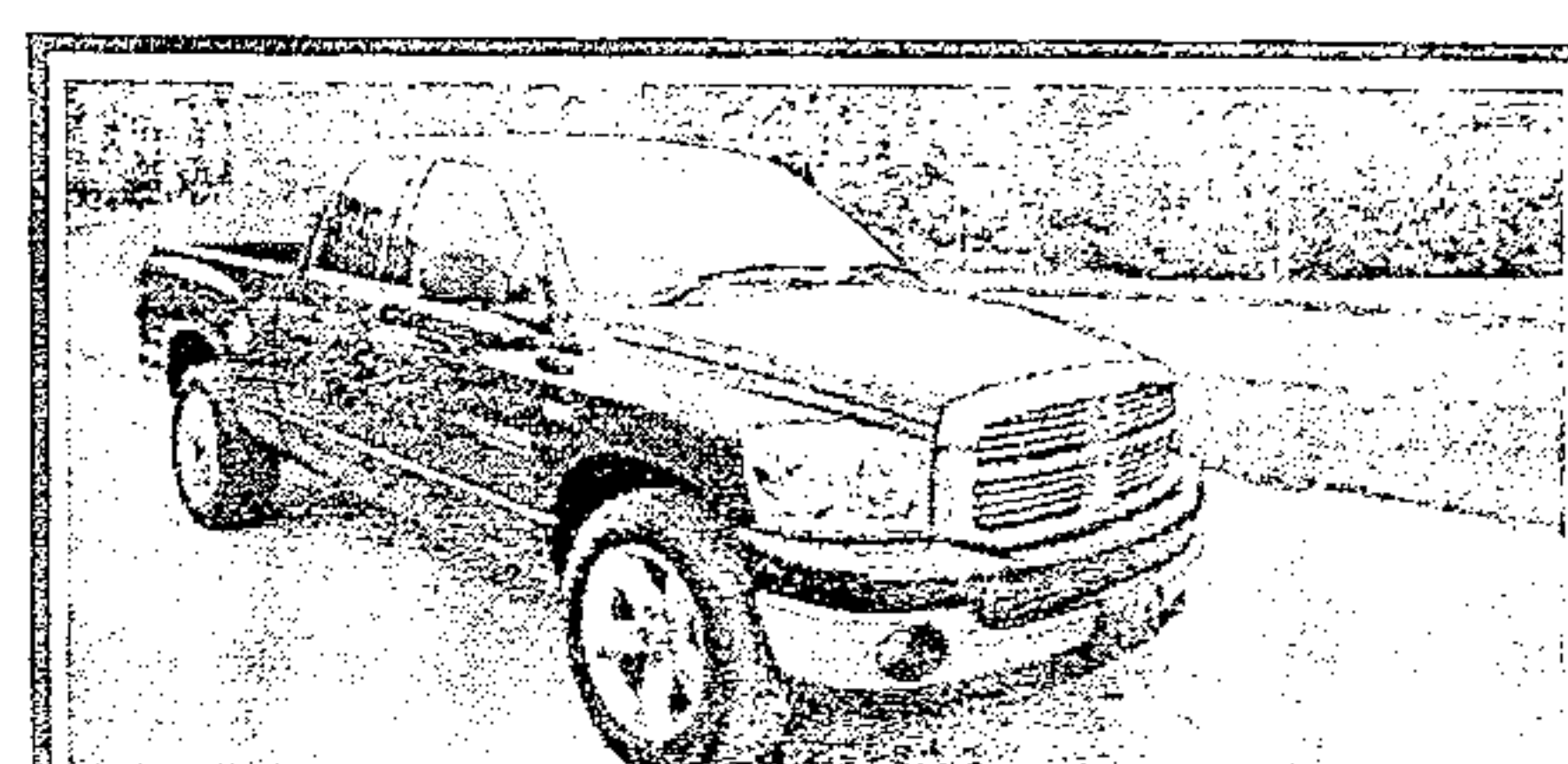

2007 Dodge Ram 1500 Quad Cab, Thunder Road PKG, 20 in. Wheels, Low Miles, Hemi

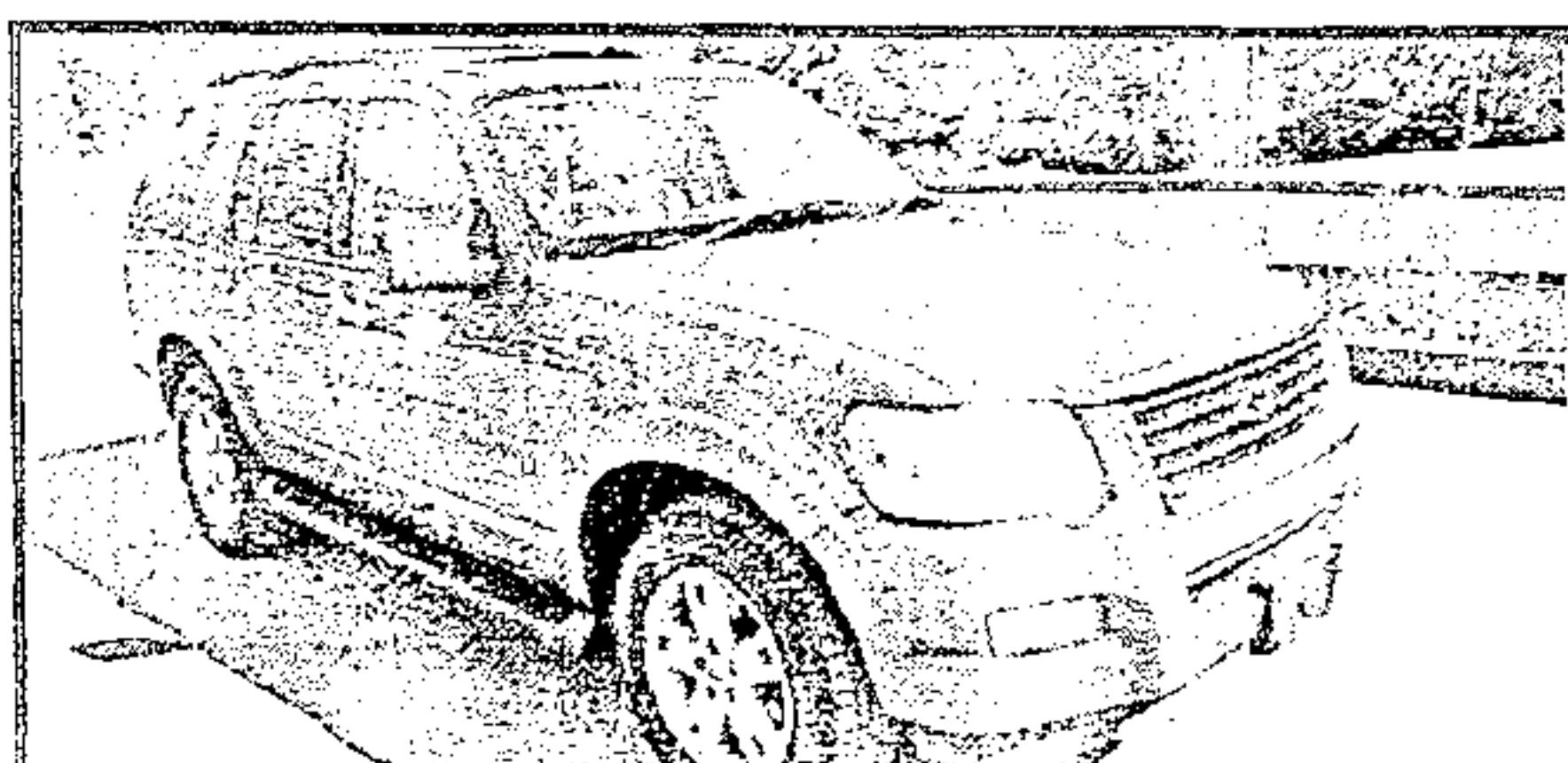

2008 Ford Explorer 84k, 3rd Row Seating, Luggage Rack, Tow Pkg, PW, PL

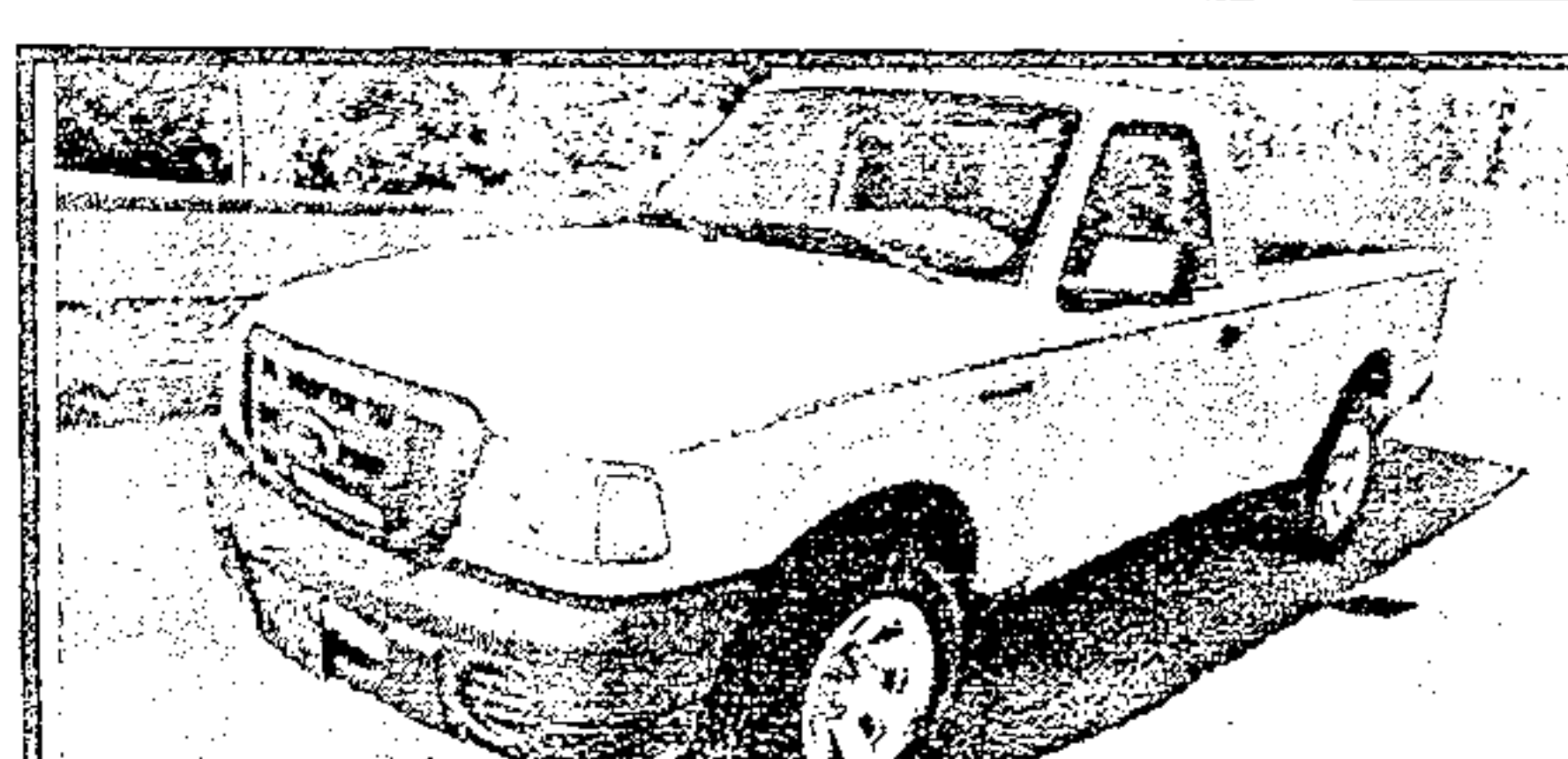

2011 Ford Ranger Low Miles, Tow Pkg, New Tires, A/C, Heat, Bed Liner.

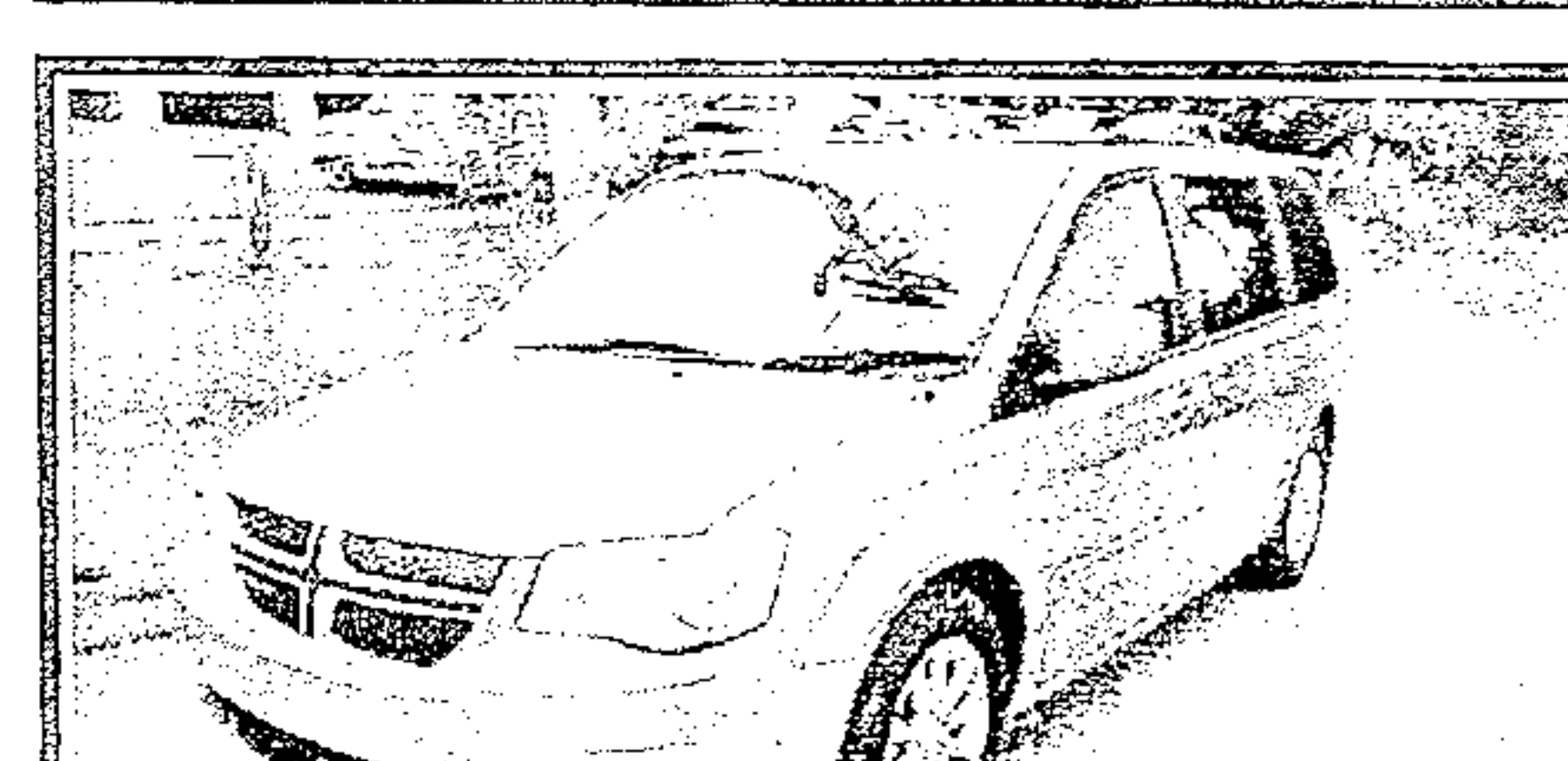

2011 Dodge Grand Caravan DVD, Stow & Go, Loaded, Remote Doors, Rear A/C

DEPENDABLE MOTORS 986-9343

803 E. Broadway • Lenoir City

* WAC. See Dealer for details

Visit our website at: www.dependablemotorslc.com

Serving Loudon County for 20 Years

library

sponsored by Friends of the Knox County Public Library, the East Tennessee Historical Society, the Knox County Public Library, Union Ave Books, and Keurig Green Mountain.

During his appearance in Knoxville, Larson will discuss his latest book, Dead Wake, which once

again brings a past event alive—this time, the last crossing of the Lusitania. Dead Wake, to be released in paperback on March 22, ushers readers aboard the Lusitania as it begins its tragic and final crossing. It is a timely trip, as 2015 marked the 100th anniversary of the disaster.

Larson, who divides his time between New York City and Seattle, is the author of four national bestsellers: In the Garden of Beasts, Thunderstruck, The Devil in the White City, and Isaac's Storm. His books have been published in 17 countries and have collectively sold more than 5.5 million copies.

Reserved-seat tickets for the author event are \$21 and will be available to the public on February 8 through knoxbijou.com, the Tennessee Theatre Box Office or by calling (865) 684-1200 (Ext. 2). Each ticket holder will receive a paperback copy of Dead Wake. A special book signing will occur on stage after the author's reading.

For more information, please visit knoxfriends.org/erik-larson.

trio ctd. from pg. 2

Tampering/Fabricating with Evidence.

Deputy Kevin Dailey LCSO, observed a black vehicle driving on Norwood St. heading towards Johnson Drive with its bright lights on, upon passing Deputy the driver dimmed the lights. A traffic stop was initiated at Browder Hollow Road and Foster where Deputy came in contact with the driver

Bradley Brooks and 3 other passengers, Roseanna Forsythe, Marcus Branyon, and a female. Bradley was ask to step out of the vehicle. After speaking with Bradley his story ad the passenger story did not match up. While patting Bradley down for weapons Deputy observed 3 clear baggies inside his shoe. Inside the baggies was what appeared to be crystal meth

(see trio conc. pg. 7)

For Sale: oak Wood Mulch

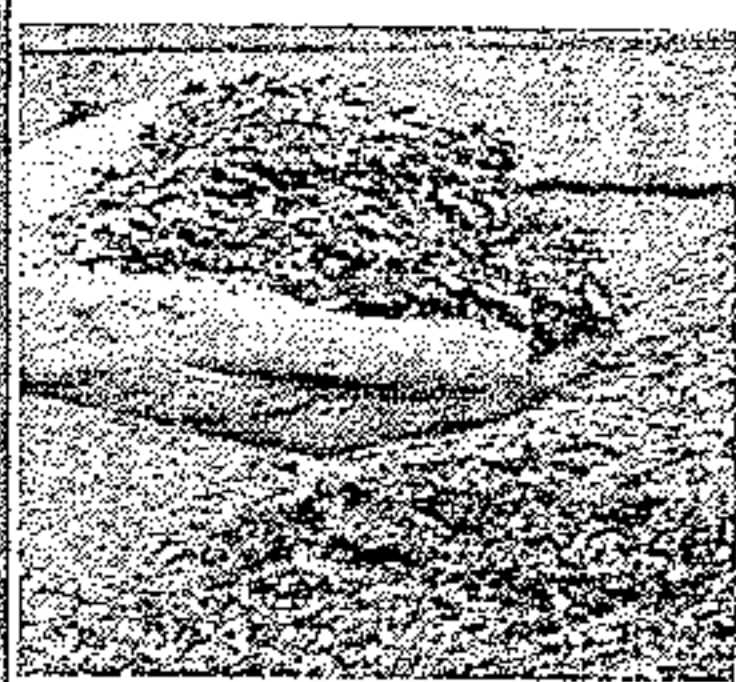

Mushroom Compost Topsoil.

Firewood



Call Steve Spoon 986-4282

West End Storage & Warehouses
502 Ward Avenue • Loudon
Call 865-458-4774 or 865-679-5555

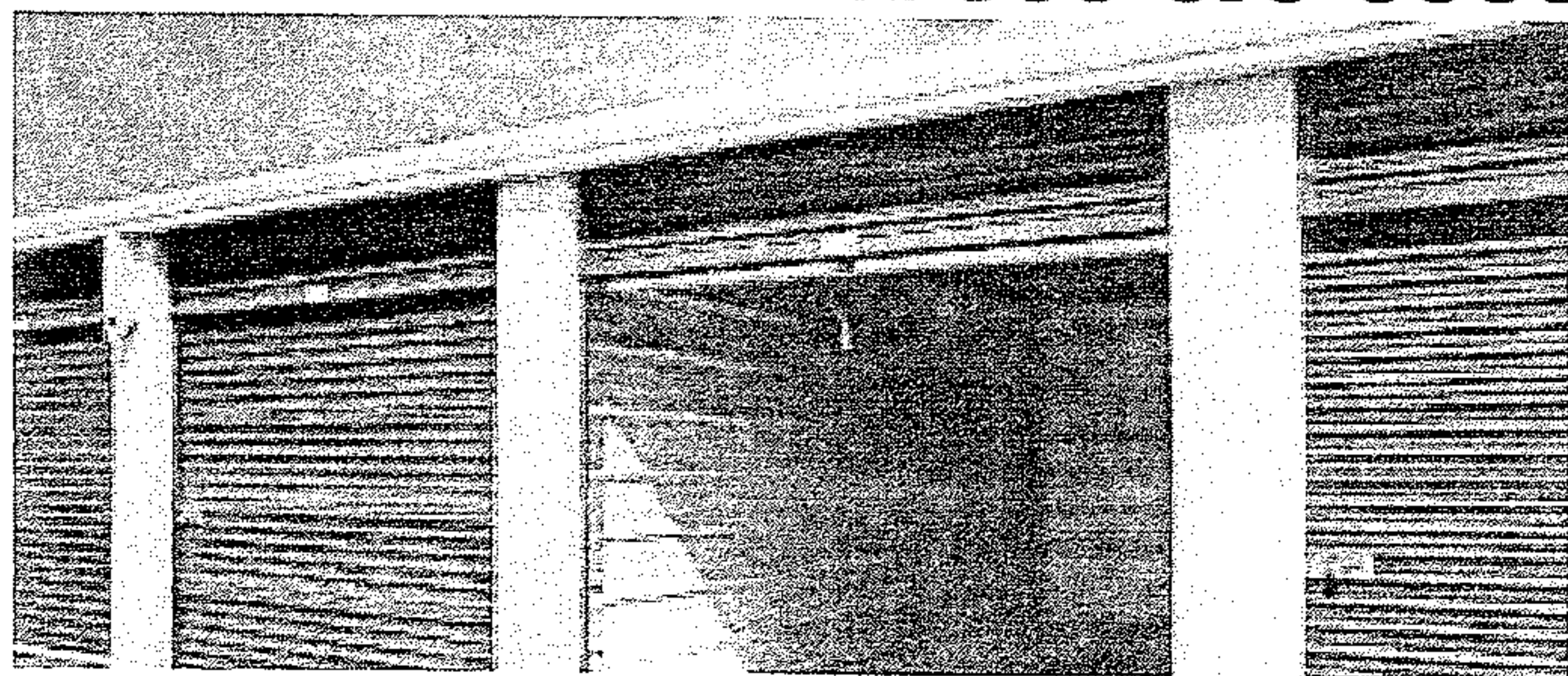

STAINED INK

TATTOO & PIERCING

LENOIR CITY 865 816-6440

NEW OWNER • NEW ARTIST • SINCE 2011

521 Hwy 321 next to Vape & Stuff & Inn Of Lenoir!

Clean-Affordable-Quality-Custom
 Tattoo's You've Always Wanted!

BRING IN THIS Ad FOR **\$25 OFF!**
 NEW INK FOR NEW CUSTOMERS ONLY!

Check us out on FB.com/
 Stained.Inc.Tattoo/
www.STAINEDINC.com



BIMBO'S

Deli Open 24 Hours

865-986-9643 Call Ins Welcome

Specials

Lg. Gold Sub, bag of chips and 16 oz. fountain drink
 only \$6.29

Footlong Corn Dog \$2.59

C&J Towing and Recovery

LOWEST TOWING RATES AROUND!!!

Have you been overcharged for any type of towing service in the Lenoir City area? If you have a breakdown or accident please OWNER REQUEST C&J Towing with the officer. Also please call your Sheriff and ask him to place C&J Towing on the "Rotation List*" and help other motorists save as much as you did! We at C&J are locally owned and operated, State approved, licensed, bonded and insured. Call and let us know if your denied service or how we can be of assistance.

*note: the "Rotation List" is a list of wrecker services that provide service for wrecks, DUI's, breakdowns, etc. and are on an on-call basis for service. This list is approved by the Sheriff.

Cliff Teeters • Owner
 865-809-1661

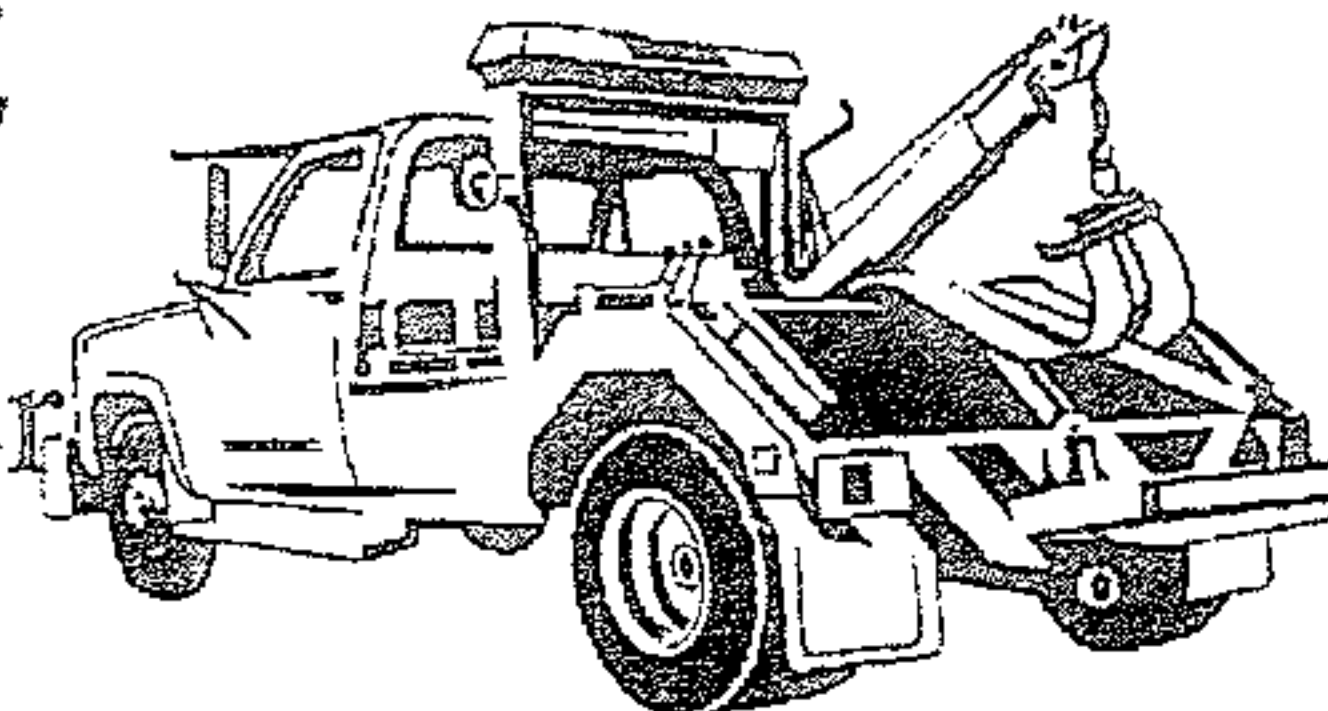

sentenced
 longing to Collins on three different dates over the course of three months. These images and videos were of minors engaging in sexual activity. The FBI, along with an Internet Crimes Against Children Task Force Officer from the Bradley County Sheriff's Department, discovered that Collins had

more than 80,000 images and 300 videos on his computer and other electronic storage media. The images and videos were compared with those from known victims through the National Center for Missing and Exploited Children's (NCMEC) database. The NCMEC database found that the images belonged to 222 known victim series and

the videos belonged to 90 known victim series.

This case was brought as part of Project Safe Childhood, a nationwide initiative to combat the growing epidemic of child sexual exploitation and abuse launched in May 2006 by the Department of Justice. Led by U.S. Attorneys' Offices and the Criminal Division's Child Exploitation and Obscenity Section, Project Safe Childhood marshals federal, state and local resources to better locate, apprehend and prosecute individuals who exploit children via the Internet, as well as to identify and rescue victims. For more information about Project Safe Childhood, please visit www.projectsafefchildhood.gov.

A-PVP

distribution conspiracy and an international money laundering conspiracy centered in northeast Tennessee,

see, southwest Virginia and western North Carolina.

A-PVP is a synthetic drug primarily ordered from China, which is commonly referred to on the street as "gravel" or "flakka." Common effects on users include: extreme paranoia; hallucinations; elevated blood pressure; extremely high body temperature; excited delirium; staying awake for days; hostility and having exceptional strength without apparent fatigue. These are many of the characteristics of the drug that make it very dangerous for the user but also for law enforcement responding to people who are high on it. A-PVP has been referred to by users of the substance as "meth on steroids."

According to the plea agreement on file with U.S. District Court, Braddock admitted that he conspired to distribute and was accountable for a conservative estimate of between 35,000 and 75,000 grams (35 to 75 kilograms) of a-PVP between January 2012 and October 2014. As early as January 2012, Braddock and co-de-

fendant Joshua Lindsey, 29, of Lyman, S.C., became involved in obtaining a-PVP from China and redistributing it for profit. In January 2013, Braddock was arrested following a search of a motel room he rented in Hendersonville, N.C., in which approximately 500 grams of a-PVP, scales, ledgers, packaging slips from China and two firearms were found. Later in the month, motel employees notified law enforcement officers that another international package had been delivered there for Braddock. This second package also contained 500 grams of a-PVP.

Braddock was granted pretrial release, but continued to obtain and distribute a-PVP from China. In February 2013, Braddock's brother, Richard Allen Lowe, 51, of Landrum, S.C., began assisting him in the conspiracy. Between February 2013 and September 2013, Lowe obtained packages of a-PVP from China and conspired to distribute approximately 12,500 grams of a-PVP. Lowe was sentenced on January 27, 2016 to serve 80 months in federal prison.

Braddock sold the majority of his a-PVP to customers and other dealers from east Tennessee at a wooded lot in Hendersonville, N.C. Braddock and another co-defendant, Richard Ware, 73, of Hendersonville, developed a system to aid in avoiding detection from law enforcement by texting back and forth with customers and executing the money and drug drops at separate times to avoid conducting hand to hand transactions. However, as the conspiracy continued, Braddock sold a-PVP on repeated occasions to a customer who was working with law enforcement. During recorded conversations and meetings with that customer, Braddock offered to sell his contact information for his a-PVP supplier in China for \$50,000.00. In another recording, Braddock told the customer, "I'm telling you person to person, if you don't do it (a-PVP), you'll make as much as you want to make, if you're gonna

(see A-PVP ctd. pg. 6)

PUBLIC NOTICE

Special-Called Purchasing Committee Meeting

The Lenoir City Purchasing Committee will be holding a special-called meeting at City Hall on Thursday, February 11, 2016 at 9:30 A.M. The purpose of the meeting will be to review and discuss the bids received in the previous Purchasing Committee Meeting.

Thank you.

How about \$50 you didn't have before?

Just come to Liberty Tax, let us do your taxes and we'll hand you \$50 cash on the spot.

119 E. Broadway Street
 Downtown Hwy 11
 820 Hwy 321 N

Across from Burger King Lenoir City, TN 37771
 865-986-8335

with paid tax preparation. Valid at participating locations. Cannot be combined with other offers or used toward past services. One coupon per return. Expires 2-15-15



PUBLIC NOTICE

Personnel Committee Meeting

The City of Lenoir City Personnel Committee will meet at City Hall, in the small conference room, on Thursday, February 11, 2016 at 9:00 A.M. The purpose of the meeting will be to discuss a proposed Job Announcement/Description for a position in the City.

Thank you.

BUDGET Transmissions

302 S. Northshore Drive Knoxville

(865) 584-4391 budget-transmissions.com

Why Buy From Budget?

Free Towing From Lenoir City or Loudon County

20 Years of BBB Zero Customer Complaints Award Member

A+ Plus Rated

Huge Transmission Inventory

Best Technicians Period!!!

Call (865) 584-4391 Today!

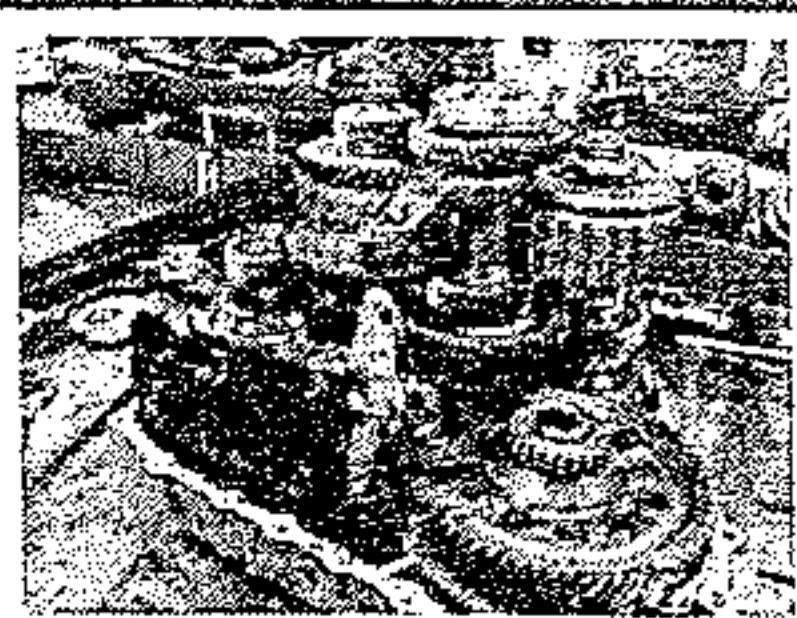

APPLY FOR AN EASY ADVANCE AND GET MONEY FAST!

\$750 Easy Advance at Liberty Tax at No Additional Cost!

820 Hwy 321 N 119 E. Broadway Street
 Across from Burger King Downtown Hwy 11

Lenoir City, TN 37771
 865-986-8335

An Easy Advance (EA) is a \$750 loan secured by your tax refund and is offered by Republic Bank & Trust Company, member FDIC, to qualifying applicants. There are no fees or interest associated with the EA. Subject to approval. Visit your Liberty office to learn more. Offer Expires 2-28-15.



FBI
Acts of cruelty against animals are now counted alongside felony crimes like arson, burglary, assault, and homicide in the FBI's expansive criminal database.

On January 1, the Bureau's National Incident-Based Reporting System (NIBRS) began collecting detailed data from participating law enforcement agencies on acts of animal cruelty, including gross neglect, torture, organized abuse, and sexual abuse.

Before this year, crimes that involved animals were lumped into an "All Other Offenses" category in the FBI's Uniform Crime Reporting (UCR) Program's annual Crime in the United States report, a survey of crime data provided by about 18,000 city, county, state, tribal, and federal law enforcement agencies.

By adding animal cruelty offenses to NIBRS, law enforcement agencies and the advocacy groups that pushed for the inclusion in the FBI

database are hoping the results will reveal a more complete picture of the nature of cruelty to animals.

"Some studies say that cruelty to animals is a precursor to larger crime," said Nelson Ferry, who works in the Bureau's Criminal Statistics Management Unit, which manages NIBRS. "That's one of the items that we're looking at."

The National Sheriffs' Association was a leading advocate for adding animal cruelty as a data

set in the Bureau's collection of crime statistics. The association for years has cited studies linking animal abuse and other types of crimes—most famously, murders committed by serial killers like Ted Bundy, Jeffrey Dahmer, and the "Son of Sam" killer David Berkowitz. The organization also points out the overlap animal abuse has with domestic violence and child abuse.

"If somebody is harming an animal, there is a good chance they also

are hurting a human," said John Thompson, deputy executive director of the National Sheriffs' Association. "If we see patterns of animal abuse, the odds are that something else is going on."

A first look at NIBRS animal cruelty statistics will be available next year, but it will take at least three to five years for the data to begin showing helpful patterns. Groups that advocated for the new animal cruelty data hope that by adding it to NIBRS—rather than the summary-based statistics agencies provide the Bureau each year—they will get a much richer data set from which to mine. That's because NIBRS requires participating agencies to not only report crimes but also all the circumstances of a crime. Additionally, the Bureau plans to phase out summary-based UCR statistics—which have been collected roughly the same way since 1930—in favor of NIBRS by 2021.

"With summary data, all I can tell you is a crime occurred," said Amy Blasher, who is leading the broader transition to NIBRS at the FBI's Criminal Justice Information Services Division, keeper of the Bureau's various crime data stores. "With the incident-based, it's more granular. It tells the story."

The move to collect more granular data requires agencies to adjust how they track and disseminate crime statistics. Only about 31 percent of the country is represented in NIBRS today—a fraction of the overall UCR participants; however, Blasher anticipates the figure to grow larger as law enforcement agencies opt in, including police departments in Washington, D.C. and Chicago over the next

(see FBI ctd. pg. 7)

PURDY'S AUTO PARTS AND SALVAGE

WE BUY SCRAP IRON • COPPER • BRASS • ALUMINUM

\$ **Paying Top \$\$\$**
Call For Latest Prices

You Name It, We Buy It!

Radiators, Wheels, Batteries, Appliances, Farm Equipment

Copper
Paying Top \$\$\$
Call For Latest Prices

Complete Cars
per 100 lbs.

Scrap Metal
Paying Top \$\$\$
Call For Latest Prices
per 100 lb

We Buy Batteries

Aluminum Cans
Paying Top \$\$\$
Call For Latest Prices

You Call We Haul!

423-519-5402



Prices subject to change with the market.

423 337-3977

149 County Road 323 Sweetwater

**Now Selling
Aftermarket
Body Parts at
Discount Prices**

Prices subject to change with the market.

DV

Kenneth Smith, 55, Foshee Road Philadelphia, was charged with Domestic Assault. Deputy Lance Anderson LCSO, responded to Foshee Road in reference to a domestic. Upon arrival Deputy made contact with the victim, who stated that her boyfriend came home from work and started arguing over employment. The victim stated during the argument Kenneth Smith grabbed her by the arm and hit her in the face with a closed fist. Deputy did observe a red mark on victim arm and face. Injuries appeared consistent with victim statement. Kenneth had

fled the scene before Deputy arrival. Deputy Lance and Brewer observed a red vehicle at Pole Kat Boat Ramp parking lot that matched the description the victim gave. Contact was made and the drier was identified as Kenneth Smith. Kenneth was placed under arrest and patted down where Deputy found a loaded handgun in his front right pocket and a loaded handgun was located in the driver side door. Deputy Lance Anderson LCSO, made the arrest.

trio conc. from pg. 3

with the other baggie containing 3 1/2 pills identified as Lisinopril. Contact was made

with the passenger Marcus Branyon who was also patted down and Deputy located several clear baggies and a scale inside his shoe.

Roseanna Forsythe who was consistently moving around in the backseat exited the vehicle where she admitted to a black bag in the backseat where someone else had left it.

Roseanna did admit she was trying to hide the bag that contained needle and a bag of crystal meth, a bag of what appeared to be Suboxone and one scale. All three parties were placed under arrest. Deputy Kevin Dailey LCSO, made the arrest.

FBI ctd. from pg. 5

two years. The FBI is aggressively pushing for the transition to NIBRS. In a speech last March in Atlanta, FBI Director James Comey said it was his personal mission to get better data "that we can all use to have informed conversations about the most important

issues we face."

Those who lobbied for better animal abuse data would agree. "With this information, law enforcement and victim services would be able to better target their intervention efforts with respect to both animal cruelty and those crimes for which animal

see FBI conc. pg. 8

JOB OPENING

Loudon County Habitat for Humanity Home Store has an opening for an Associate. This 30-hour a week position provides services related to the pickup of donated goods outside the store, and the movement of donations in the store. Assists with scheduling, determining routes, and driving the store truck. Must be able to lift 50 pounds and be able to read a map and follow directions. Must have a valid driver's license. Must be adaptable to rapidly changing conditions and have good interpersonal skills. Applications available at the store T-F 9:00-5:00 and Sat. 8:00-1:00. 303 Simpson Road East, Lenoir City. Drug Free Workplace - EOE

LOOK! \$75 Weekly Payments LOOK!

MARTY'S AUTO SALES • 986-2222 • MARTY'S AUTO SALES • 986-2222 • MARTY'S AUTO SALES • 986-2222 • MARTY'S AUTO SALES • 986-2222 • MARTY'S AUTO SALES •

- Bad Credit
- Divorce
- Fixed Income
- Repos
- Bankruptcy
- No Credit



APPROVED!

NO CREDIT CHECKS

Visit Us On The Web At: martysautosales.net

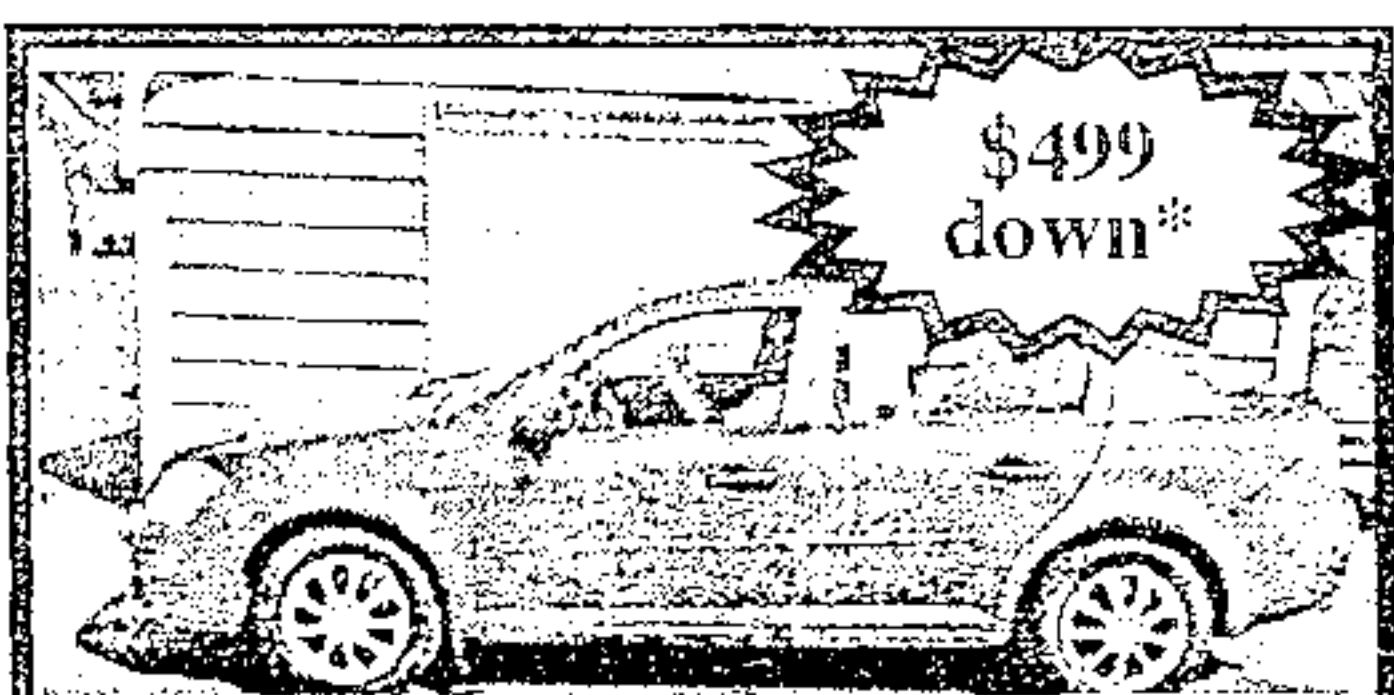

\$499 down*

07 Cobalt, 5spd, gas saver, runs great Only \$499 down *

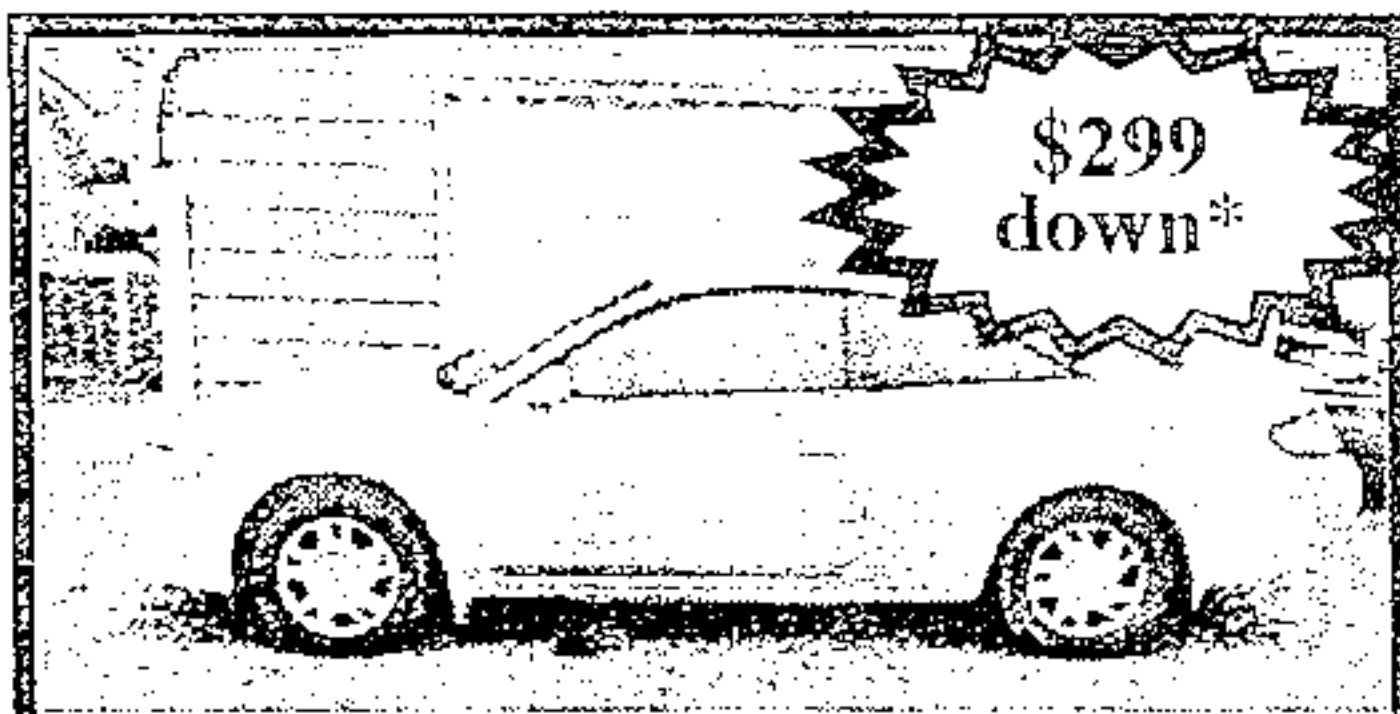

\$299 down*

99 Solara, V6, auto, sporty, Only \$299 down *

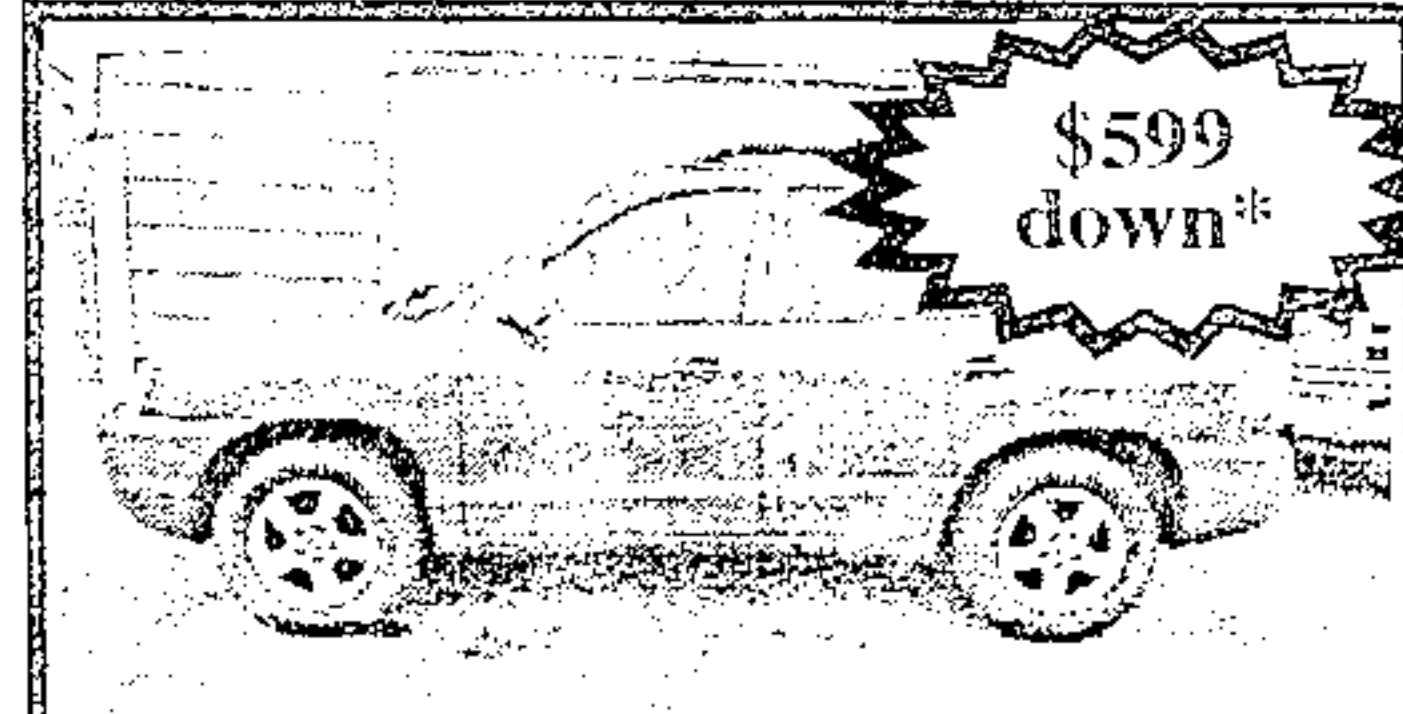

\$599 down*

04 Santa Fe, auto, Nice, clean, Only \$599 down *

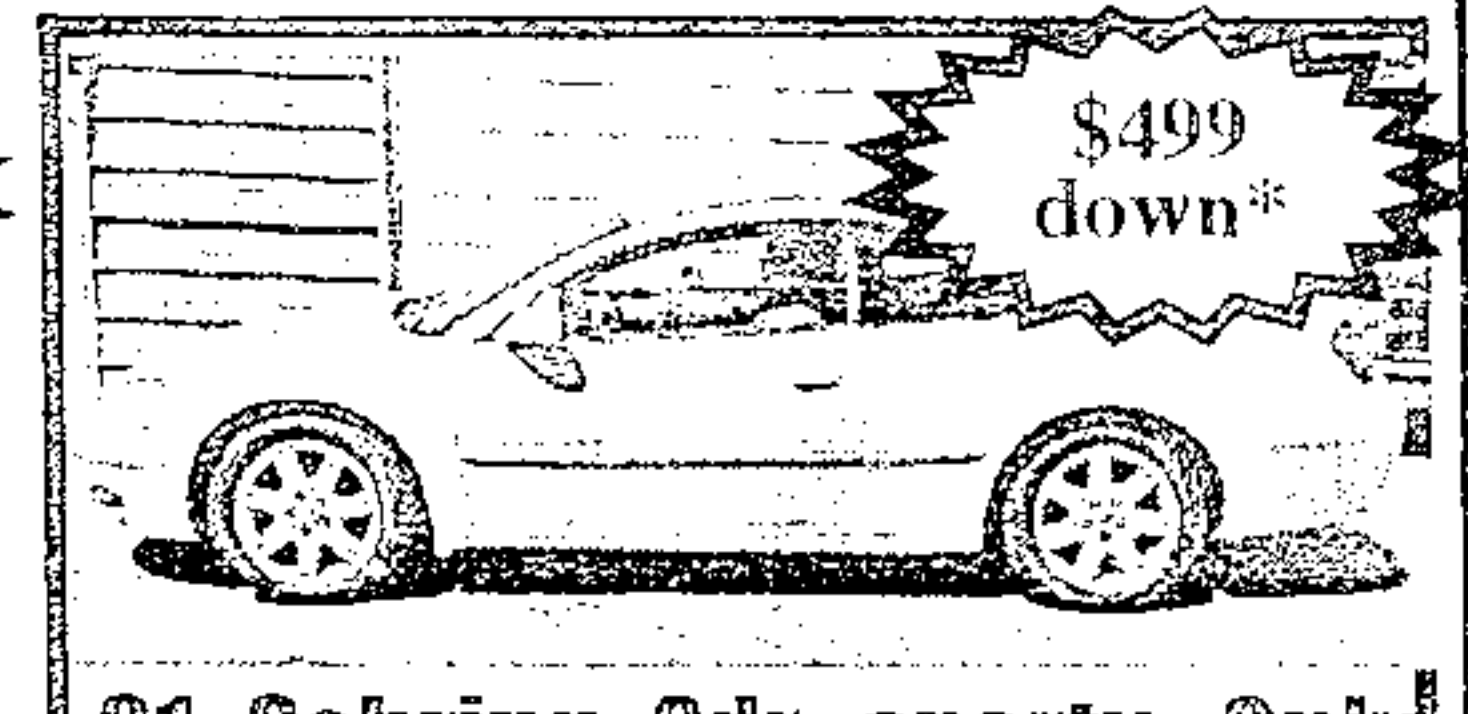

\$499 down*

01 Sebring 2dr. sporty, Only \$499 down *

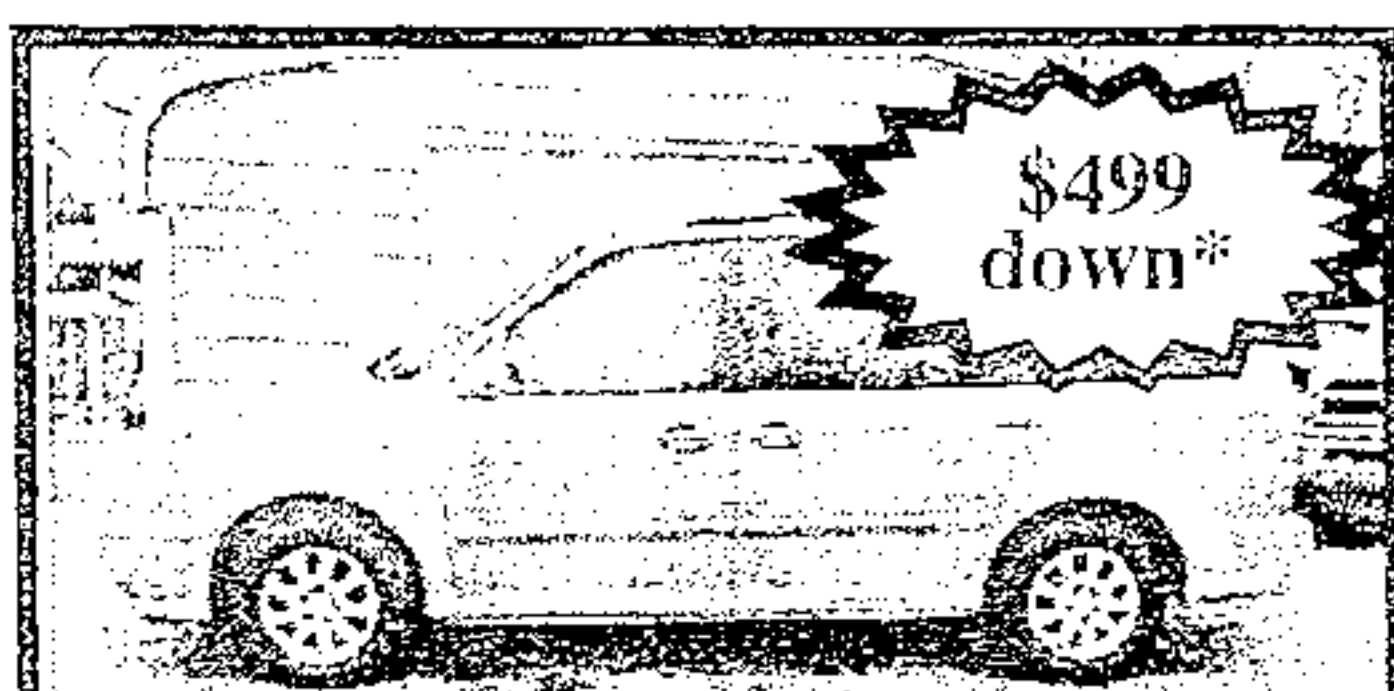

\$499 down*

05 Sedona, Runs Great, Only \$499 down *

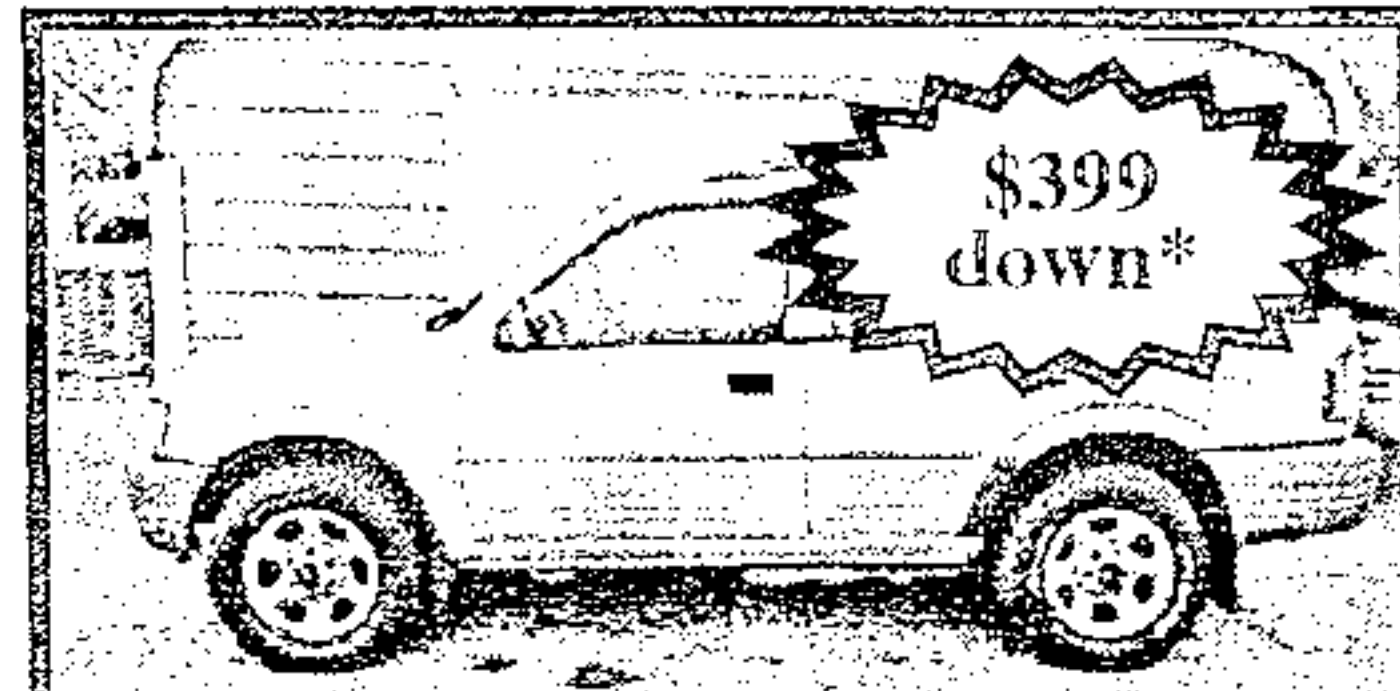

\$399 down*

01 Rodeo, 4cyl, 5spd, Gas Saver Only \$399 down *

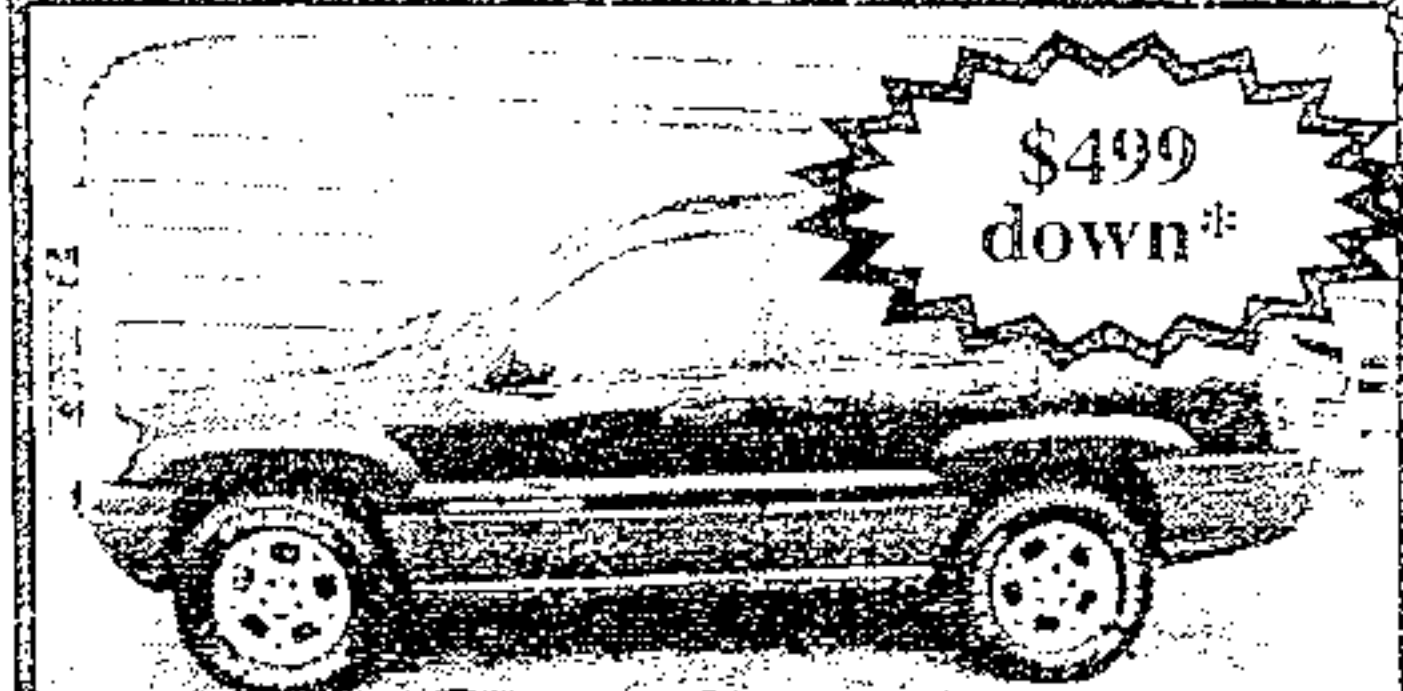

\$499 down*

99 Grand Cherokee, Loaded, lthr, Only \$499 down *

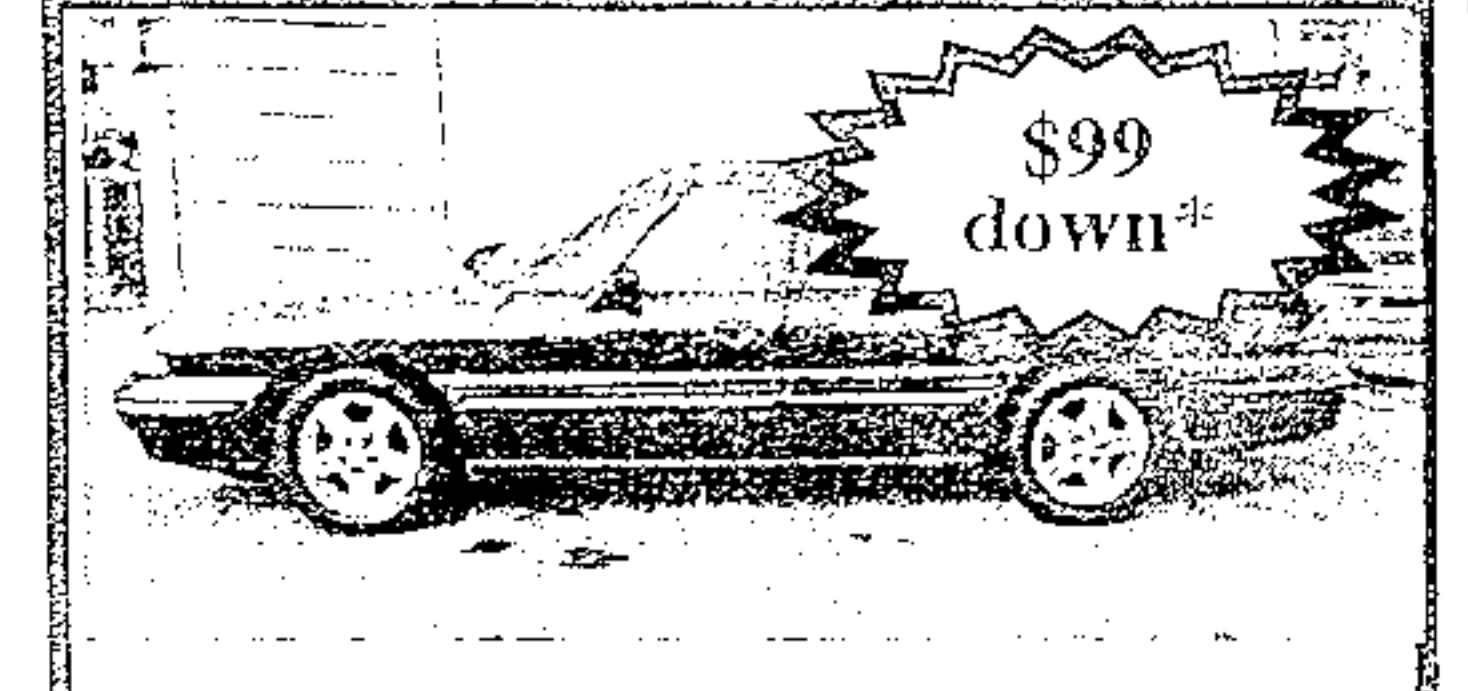

\$99 down*

98 Bonneville, 6 cyl, Auto, low payments only \$99 down *

NO Credit Checks

Marty's Auto Sales
986-2222

Se Habla Espanol

100% Approval

*See Dealer for details. All down payments plus tax, tag, title and fees.

MARTY'S AUTO SALES • 986-2222 • MARTY'S AUTO SALES • 986-2222 • MARTY'S AUTO SALES • 986-2222 • MARTY'S AUTO SALES • 986-2222 • MARTY'S AUTO SALES •

FBI conc. from pg. 7

cruelty serves as a marker," said Dr. Mary Lou Rاندour of the Animal Welfare Institute, which worked closely with the National Sheriffs' Association to advance their cause. "Identifying and analyzing animal cruelty crimes would provide an important tool for law enforcement."

The National Sheriffs' Association's John Thompson urged people to shed the mindset that animal cruelty is a crime only against animals. "It's a crime against society," he said, urging all law enforcement agencies to participate in NIBRS. "By paying attention to [these crimes], we are benefiting all of society."

THE RELIC SHOP

521 Hwy 321 Lenoir City Suite 3
next to Stained Inc and the Inn of Lenoir
865-250-9280

WE ARE IN TUCSON, ARIZONA BUYING UP FOSSILS FOR THE SHOP. WE NEED TO MAKE ROOM!!!

ALL AMETHYST 40% OFF

GREAT SELECTION OF ANCIENT MEGALODON SHARK TOOTH OVER 8 MILLION YEARS OLD

Is Your Washer Broken?

Call Me

I Only Charge \$100 Period!!!

Call Allen

865-617-7113

A Name You Already Know And Trust Just Got Even More Dependable
DEPENDABLE AUTO SERVICE, LUBE AND TIRES
is Now Offering
Expert, Affordable Transmission Service

All ASE Certified Technicians

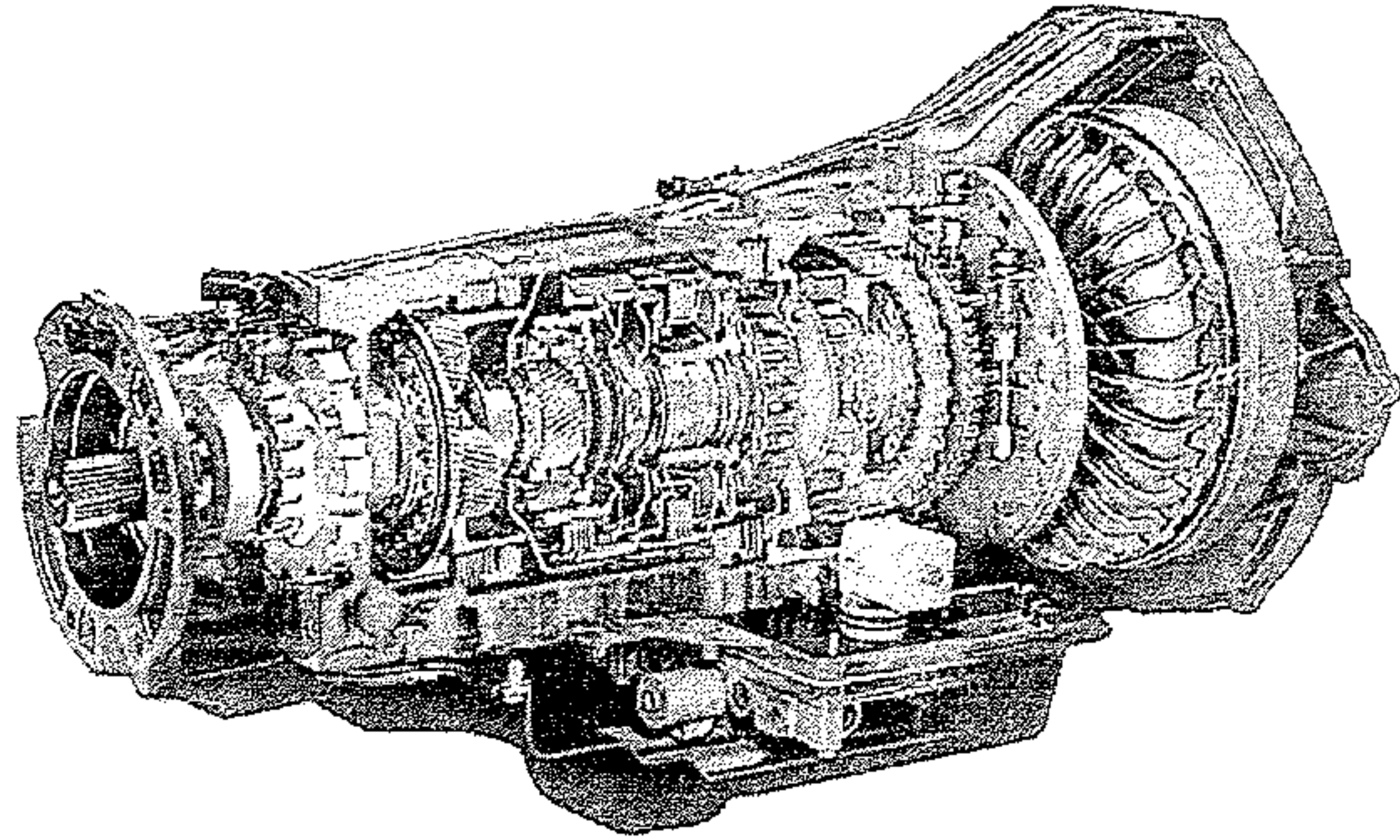

We proudly welcome all New Customers and Former Advanced Transmission Customers with a 10% Discount and Any Transmission Service or Repair*

865-986-9359

865-986-5050

Bad Credit, No Credit OK!!! We Finance Everybody!!!

Taxes Done Here!!! Bring your last pay stub or W2 and DRIVE TODAY!!!

Over 100 Cars, Trucks & Vans in Stock - Warranties On ALL Vehicles Sold!!!

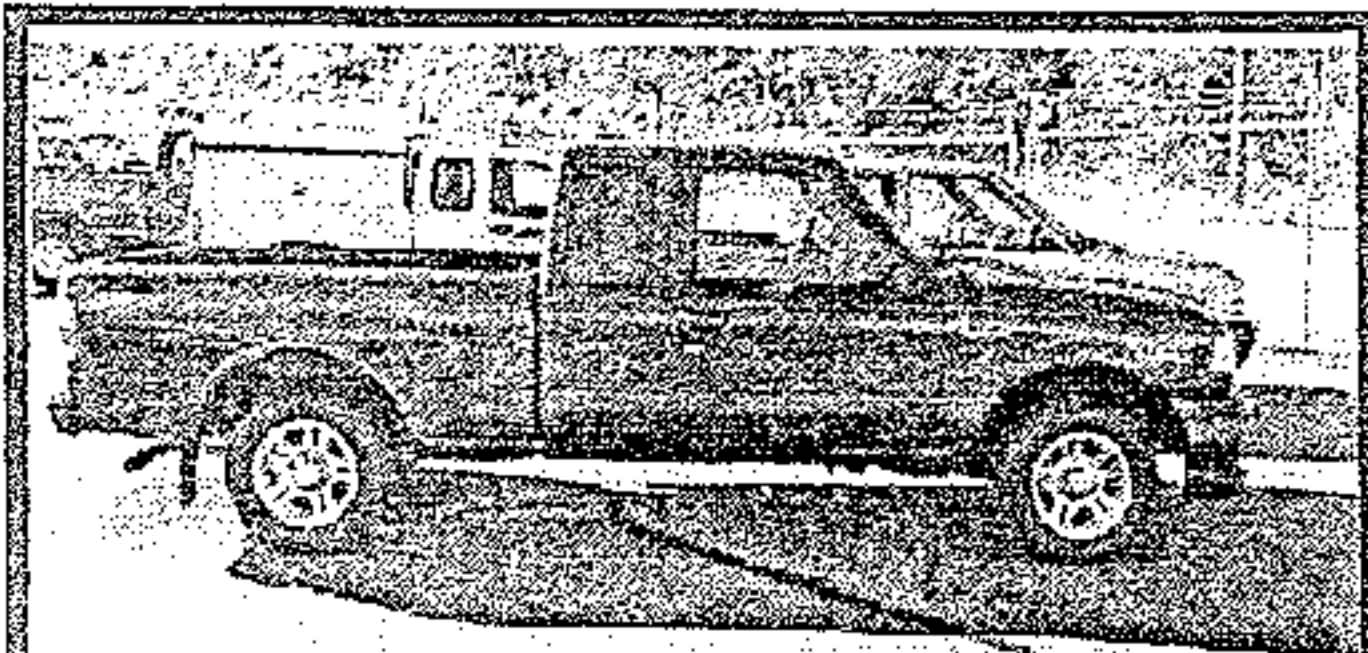

2005 Ford Ranger, Super Nice Truck, Very Low Miles

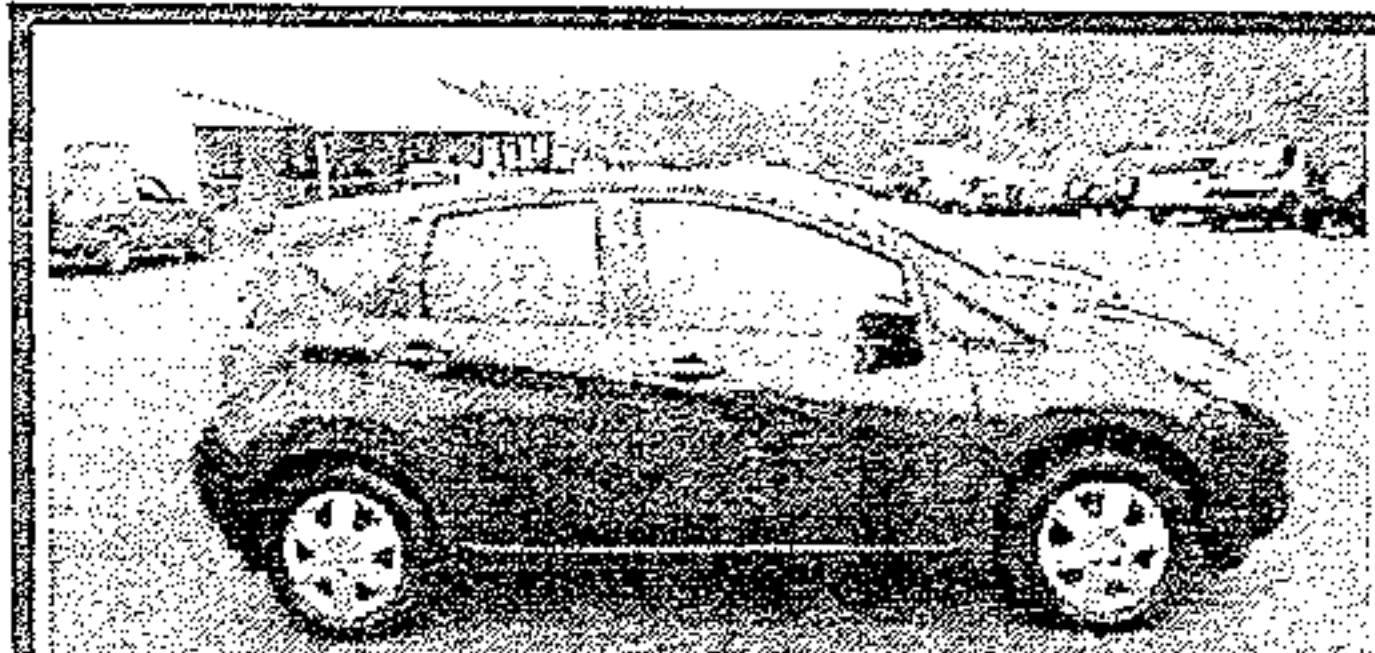

2015 Nissan Versa Note, Factory Warranty, Low Miles



2011 Kia Soul, 5 speed, 4 dr, Gas Saver, Nice & Clean



2007 Chevy Equinox, 4dr, Extra Clean, lots of room

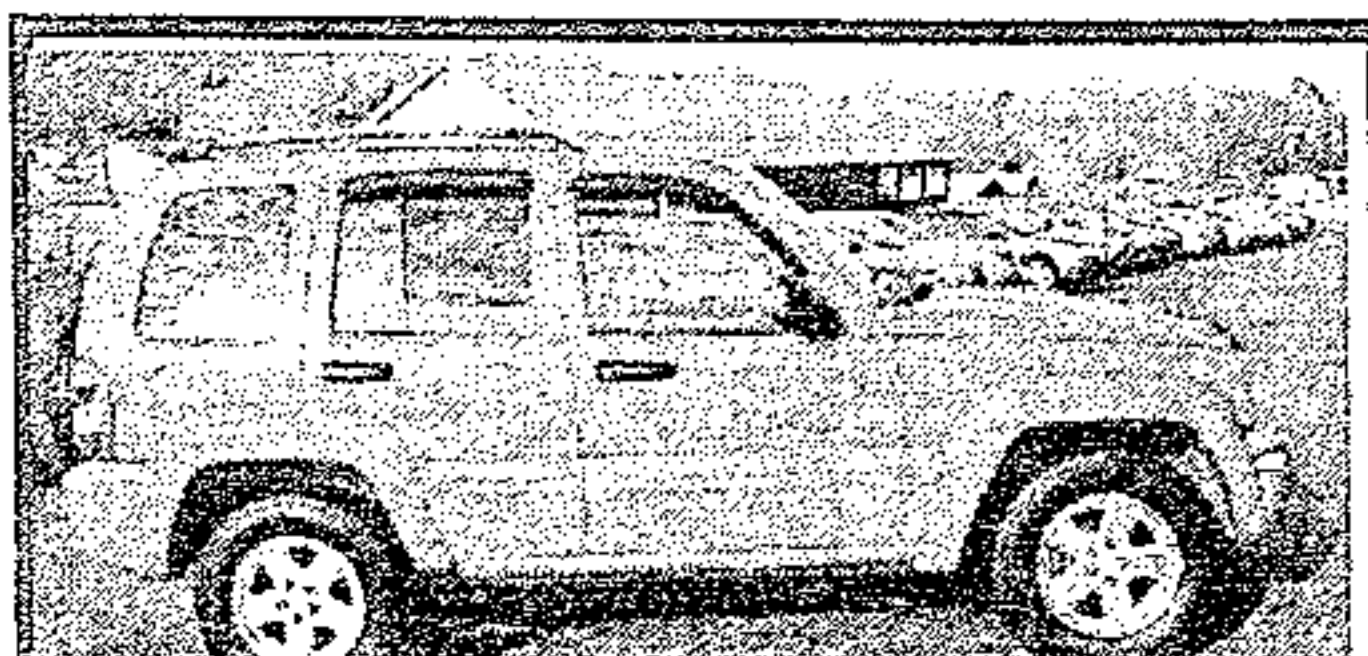

2004 Jeep Liberty, 77k miles, Leather, LOADED!!!

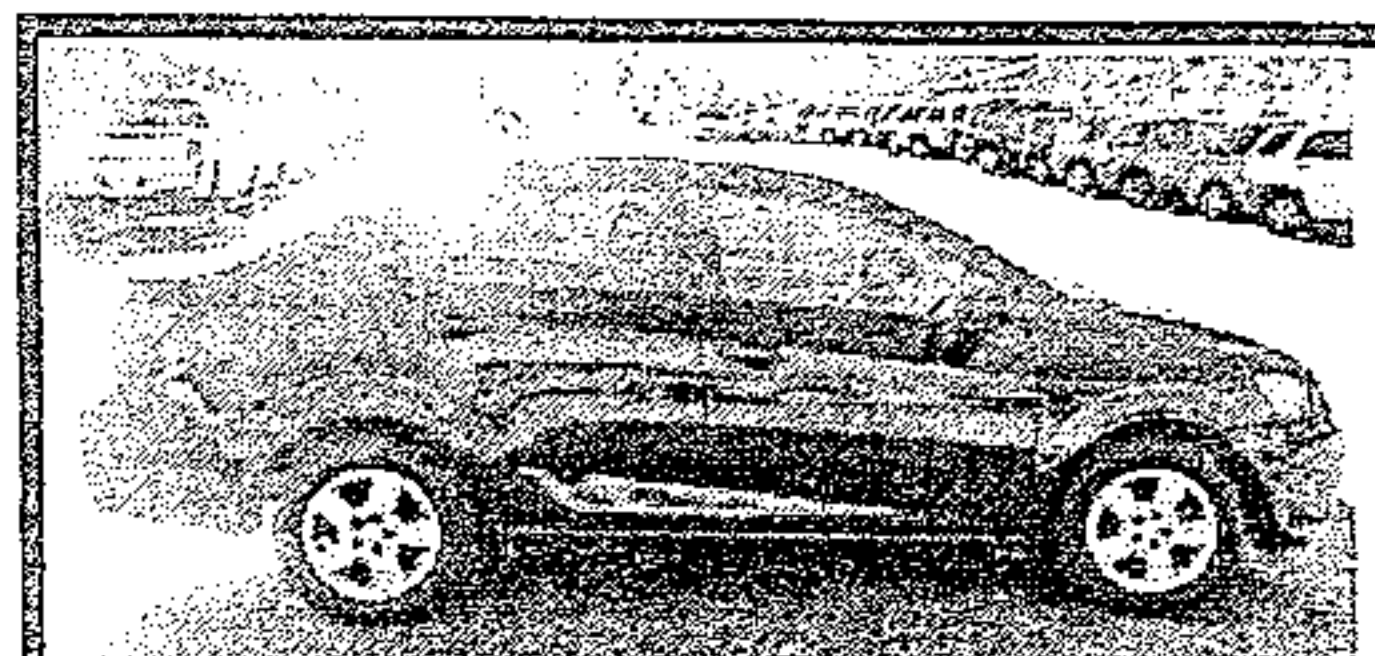

2014 Chevy Sonic, Factory Warranty, Low Miles!

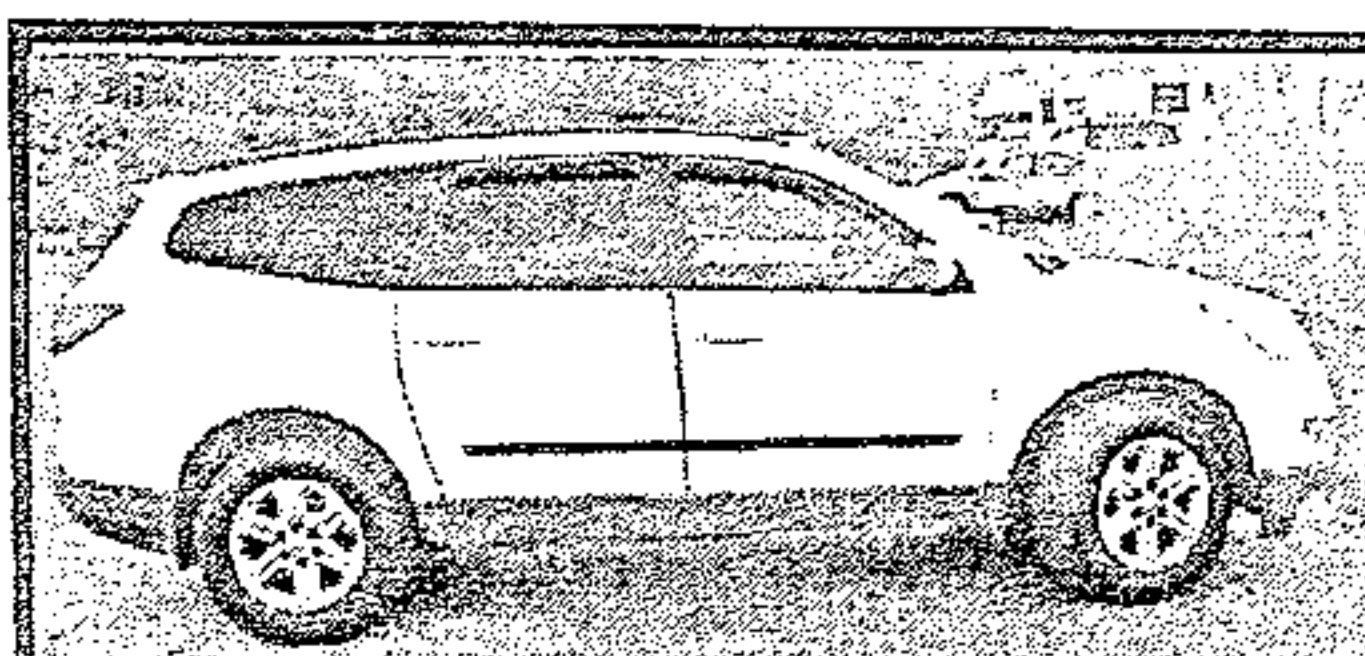

2010 Chevy Traverse, 3rd row seat, Loaded, Clean

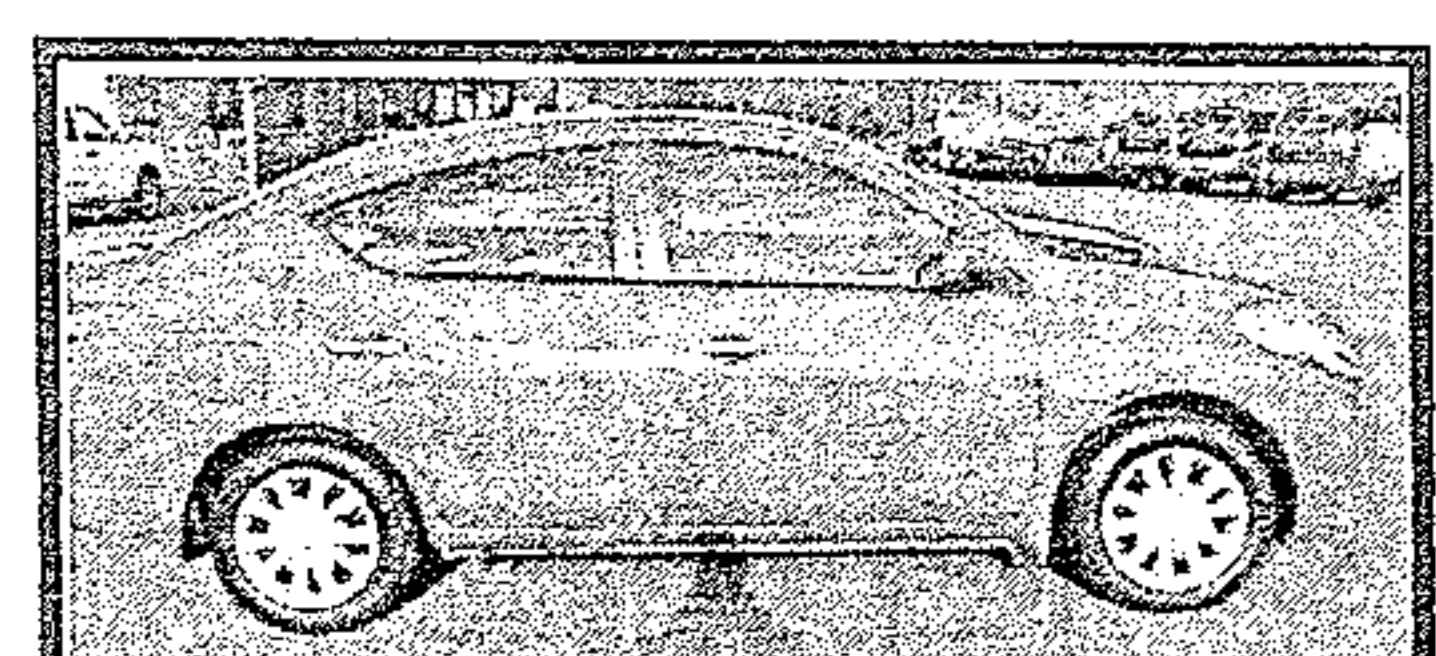

2013 Nissan Versa, Like New! LOADED!!!

WALT WILLIAMS, INC.

*with approved credit

3003 Highway 11

Lenoir City, TN

865-986-1111