

The Daily Edition

50¢

Serving Loudon, Monroe and Surrounding Counties

Thursday, February 4, 2016

Update: charged man shot to death; girlfriend now charged

Melody Telfer, 34, Grandview Drive Lenoir City, was charged with Aggravated Statutory Rape x2. On 1/26/16 Sgt. Detective Charlie Cosner LCSO, went to speak with Cpl. Estes who sated that he had received information that a juvenile had been a victim of statutory rape.

(see rape pg. 2)



Melody Telfer

Beer dropped by DUI driver after collision



Jare Barkley

(see DUI pg. 5)

Over \$800 stolen in shoplifting spree

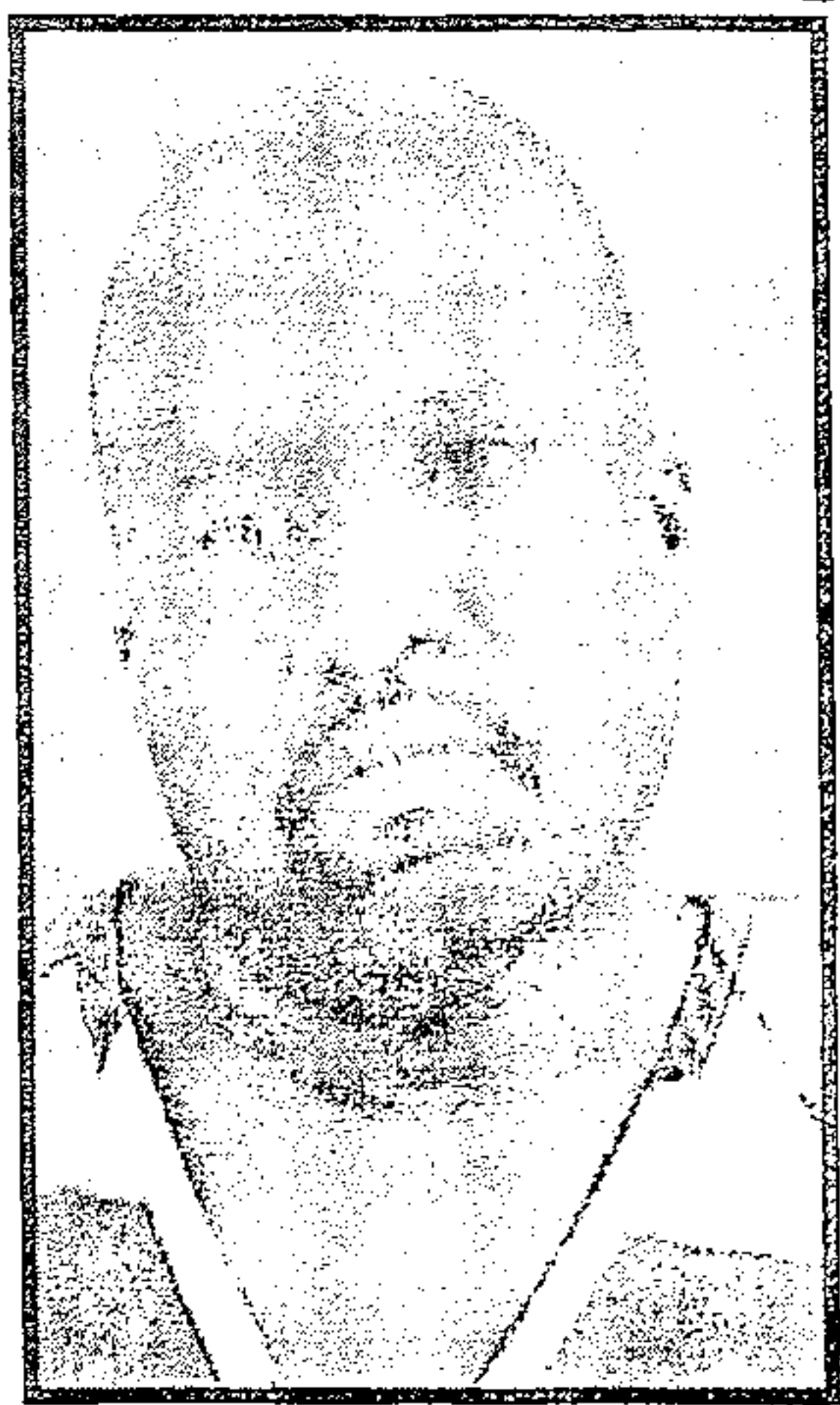

Bobby Bell

(see theft pg. 7)



Steven Brannan

Michael Schmidt sentenced to serve 33 months in prison for wire fraud

Michael Frank Schmidt, 60, of Jonesborough, Tenn., was sentenced on Feb. 2, 2016, by the Honorable R. Leon Jordan, U.S. District Court Judge, to serve 33 months in federal prison. Judge Jordan also imposed a three-year term of

(see fraud pg. 5)

Pot prosecution bill clears key hurdle

A Republican-sponsored bill that would make three or more convictions for simple possession or casual exchange of marijuana a misdemeanor rather than a felony passed a key hurdle on Tuesday.

With a unanimous 9-0 vote, the Senate Judiciary Committee approved a bill that would make changes to the prosecution of those found guilty of possessing marijuana and other controlled substances three or more times.

The move is expected to decrease the state's incarceration costs by as much as \$2 million, according to the bill's fiscal note.

(see bill pg. 4)

Comptroller Releases Report on Charter School Facilities

The Comptroller's Offices of Research and Education Accountability (OREA) has released a re-

port that examines the way charter school facilities are funded in Tennessee. The

(see report pg. 3)

Verse of the Day

.Since they hated knowledge and did not choose to fear the LORD ... they will eat the fruit of their ways and be filled with the fruit of their schemes. — Proverbs 1:29,31

Obituaries

see inside Wazzup

A super-duper thank you, thank you, thank you to the crew at LUB for your extraordinary service. LUB goes

above & beyond for it's customers and it is appreciated!!!

Weather

Today: Intervals of clouds and sunshine. High 48F. Tonight: Clear skies. Low near 25F. Friday A mainly sunny sky.

High 48F. Friday Night A few clouds. Low 28F.

Horoscopes

Aquarius 1/20-2/19

Dig down to the source of your uneasiness today if you're uncomfortable

(Continued on page 6)



Public Notice

The Lenoir City Council Meeting scheduled for Monday, February 8, 2016 has been cancelled. The next scheduled City Council Meeting will be held on Monday, February 22, 2016 at 7:00 P.M.

Thank you.

HACIENDA *Ayala's*

Mexican Restaurant

Market Dr. * Lenoir City (In Front of Food City)

Real Authentic Mexican Food at Affordable Prices

BEST
MARGARITA

You've Tried The Rest
Now Come Have The Best!!!

We Accept ALL Competitors Coupons Outside of Mexico City!
986-3553

rape

The girlfriend of the suspect Thongsavanh Vandarack had told another individual. The girlfriend was identified as Melody Telfer, both live on Grand View Drive. After an investigation warrants were

issued for Vandarack. Melody was taken into custody for further investigation.

Upon completion of the investigation, Det. Charlie Cosner charged Melody with 2 counts of Aggravated Statutory Rape.

Notice: The Daily Edition does not knowingly accept fraudulent or misleading materials. The Daily Edition cannot guarantee the validity of offerings or statements contained herein. All liability for the contents of all advertising, and for any claims that may arise therefrom, is the responsibility of the advertiser or its agency. The Daily Edition reserves the right to reject, edit, or abbreviate any advertisement submitted. Advertising is accepted with the understanding that all liability for all copyright violations is the sole responsibility of the advertiser.

Photographs, artwork and other copy submitted for publication is considered the sole property of the advertiser. The Daily Edition will make every effort but will not be liable for failure to publish and ad or for typographical and layout errors. All statements and information about highlights featured items, letters to the editor, herein are those solely given to the interviewer or writer and the Daily Edition assumes no responsibility of the accuracy or validity thereof. The Daily Edition will gladly reprint at no charge that part of an advertisement in which an error occurs provided a claim is made within 3 days of the first publication of the ad. Information contained in the Wazzup is received anonymously and the Daily Edition assumes no responsibility for information and reserves the right to edit or reject any and/or all submissions. The Daily Edition is a daily newspaper of general circulation in Loudon County defined under TCA 2-1-104(a)(13).

The Daily Edition also serves Monroe, Knox, Anderson, Roane and Blount counties and serves 30,000 readers weekly. Send mail to PO Box 1240, Lenoir City TN 37771. 865-771-2249. email: dan1204us@yahoo.com

The Daily Edition is Loudon County's premier public interest and paid advertising paper. The Daily Edition is produced and published daily Monday through Friday and is circulated throughout Loudon County and parts of Monroe and Knox Counties. Display advertising rates \$5.00 per column inch and quantity discounts available. Call for information on upcoming promotions and events.

Good Credit OK • Bad Credit OK • Bankruptcies OK • Repo OK



2010 Kia Soul Sporty, 4 cyl, Auto, PW, PL, A/C, Great On Gas, Like New



2010 Ford Escape Limited Leather, Alloy Wheels, Heat, A/C, Luggage Rack, 79K,



2007 Dodge Ram 1500 Quad Cab, Thunder Road PKG, 20 in. Wheels, Low Miles, Hemi



2008 Ford Explorer 84k, 3rd Row Seating, Luggage Rack, Tow Pkg, PW, PL



2011 Ford Ranger Low Miles, Tow Pkg, New Tires, A/C, Heat, Bed Liner.



2011 Dodge Grand Caravan DVD, Stow & Go, Loaded, Remote Doors, Rear A/C

DEPENDABLE MOTORS 986-9343

803 E. Broadway • Lenoir City

Serving Loudon County for 20 Years

* WAC. See Dealer for details

Visit our website at: www.dependablemotorslc.com

report

report provides information on the facilities arrangements for Tennessee's charter schools and describes efforts in Tennessee and other states to provide charter schools with facilities-related assistance.

Charter schools are public schools operated by independent governing bodies and are authorized by one

of the following three entities in Tennessee: local boards of education, the Achievement School District (ASD), or the State Board of Education (SBOE). The majority of charters in Tennessee are authorized by local boards of education. As of the 2015-16 school year, 97 public charter schools operate in Tennessee. These schools are located in Hamilton County (3), Knox County (1), Metro Nashville (27), Shelby County (45), and the Achievement School District (21).

Charter schools authorized by school districts and the State Board of Education must secure their own facility arrangements. Once a charter school's application is approved, it is the responsibility of the school operator to secure its own school facility; neither the local board of education nor the SBOE is required to provide a facility to the charter schools they authorize. ASD charter schools neither lease nor own their school facilities and are not responsible for securing a school facility. Almost all charter schools in the ASD are instead located in a school facility previously operated by a local school district and subsequently

taken over by the ASD because of low academic performance.

Unlike traditional schools, which are the property of the local board of education, most charter schools either lease, own, or have financed to own their school facility. The majority of Tennessee's charter schools lease their facilities, either from private property owners (50 percent), their authorizing school district (22 percent), or public entities such as a city or county government (9 percent). The remaining schools own or have financed to own their buildings.

Nationally, programs to provide charter schools with facilities-relat-

ed assistance typically fall into four general categories:

- Access to district facilities,
- Assistance with borrowing money,
- Dedicated per-pupil funding, and
- Competitive state grants

OREA is a division within the Comptroller's Office that is charged with providing accurate and objective policy research and analysis for the Tennessee General Assembly and the public.

To view the full report online, go to: <http://www.comptroller.tn.gov/OREA/>

For Sale: oak Wood Mulch

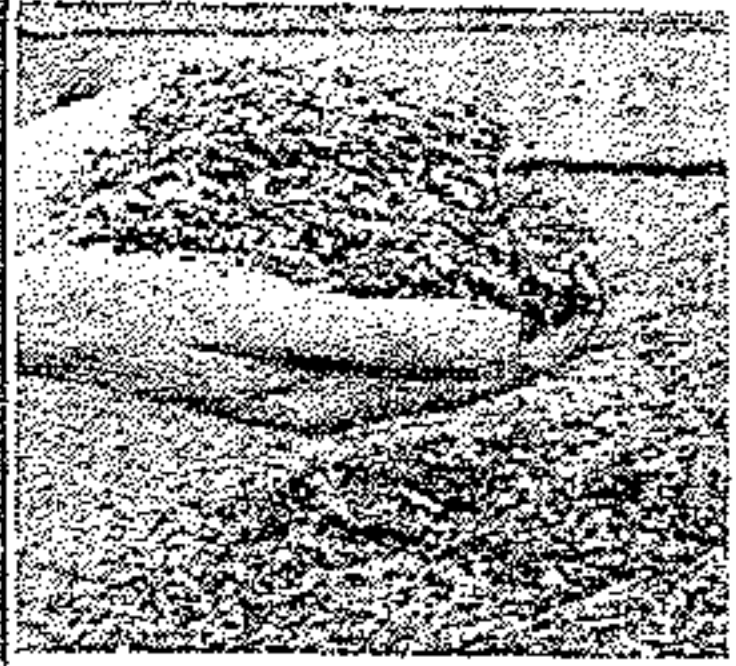

Mushroom Compost Topsoil.

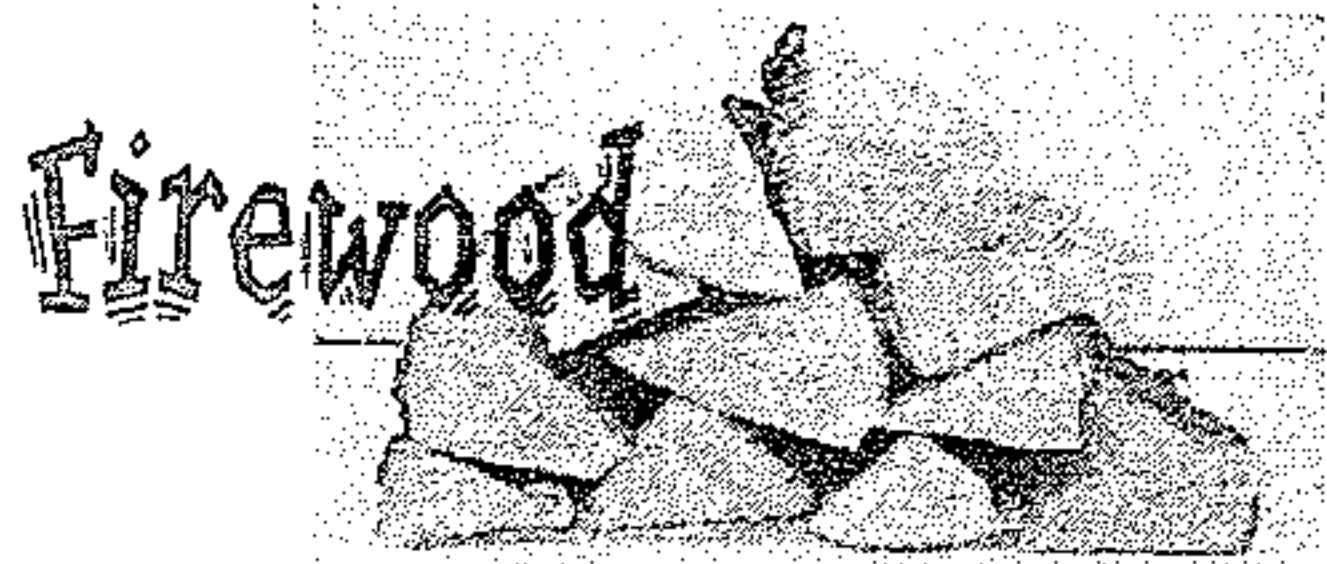

Call Steve Spoon 986-4282

West End Storage & Warehouses
502 Ward Avenue • Loudon
Call 865-458-4774 or 865-679-5555

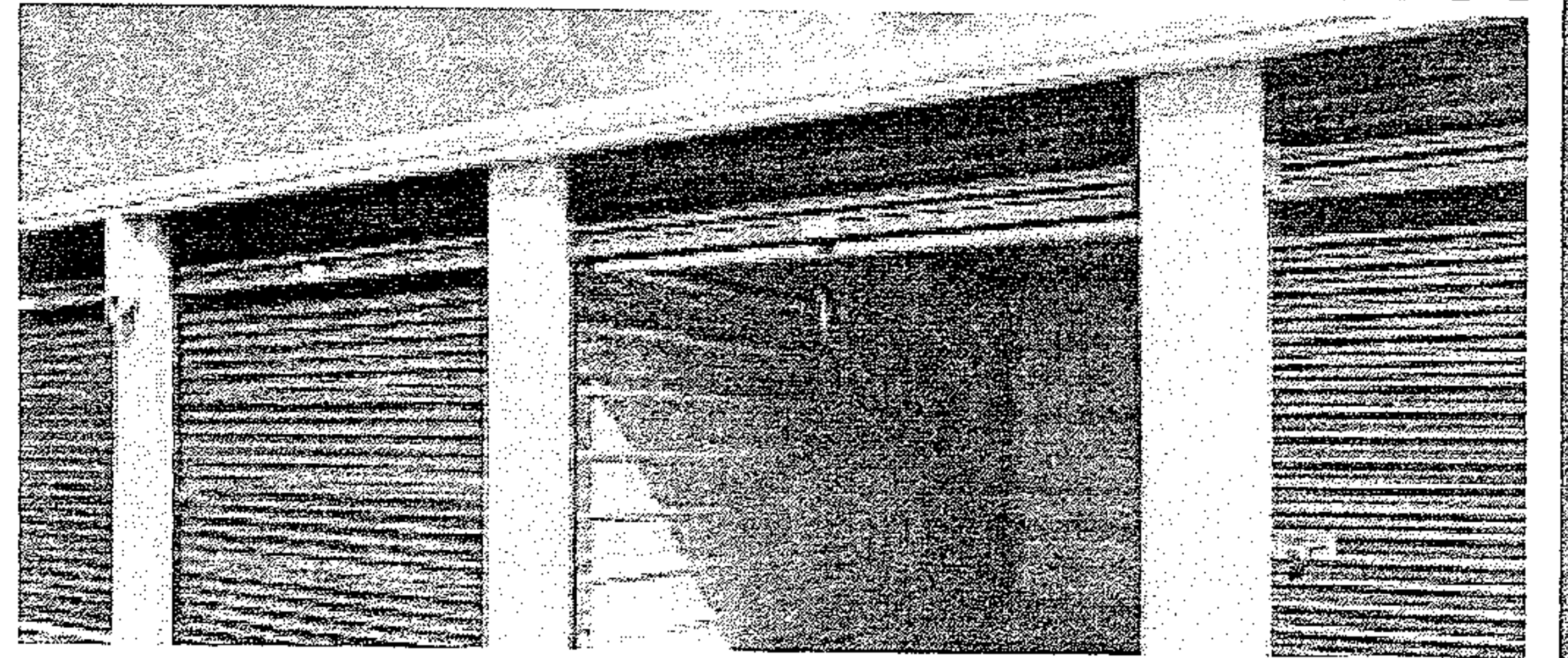

STAINED INC

TATTOO & PIERCING

LENOIR CITY 865 816-6440

NEW OWNER • NEW ARTIST • SINCE 2011

521 Hwy 321 next to Vape & Stuff & Inn Of Lenoir!

Clean-Affordable-Quality-Custom

Tattoo's You've Always Wanted!

BRING IN THIS AD FOR **\$25 OFF**
 NEW INK FOR NEW CUSTOMERS ONLY!

Check us out on FB.com/
 Stained.Inc.Tattoo/
www.STAINEDINC.com

C&J Towing and Recovery

LOWEST TOWING RATES AROUND!!!

Have you been overcharged for any type of towing service in the Lenoir City area? If you have a breakdown or accident please OWNER REQUEST C&J Towing with the officer. Also please call your Sheriff and ask him to place C&J Towing on the "Rotation List*" and help other motorists save as much as you did! We at C&J are locally owned and operated, State approved, licensed, bonded and insured. Call and let us know if your denied service or how we can be of assistance.

*note: the "Rotation List" is a list of wrecker services that provide service for wrecks, DUI's, breakdowns, etc. and are on an on-call basis for service. This list is approved by the Sheriff.

Cliff Teeters • Owner
 865-809-1661

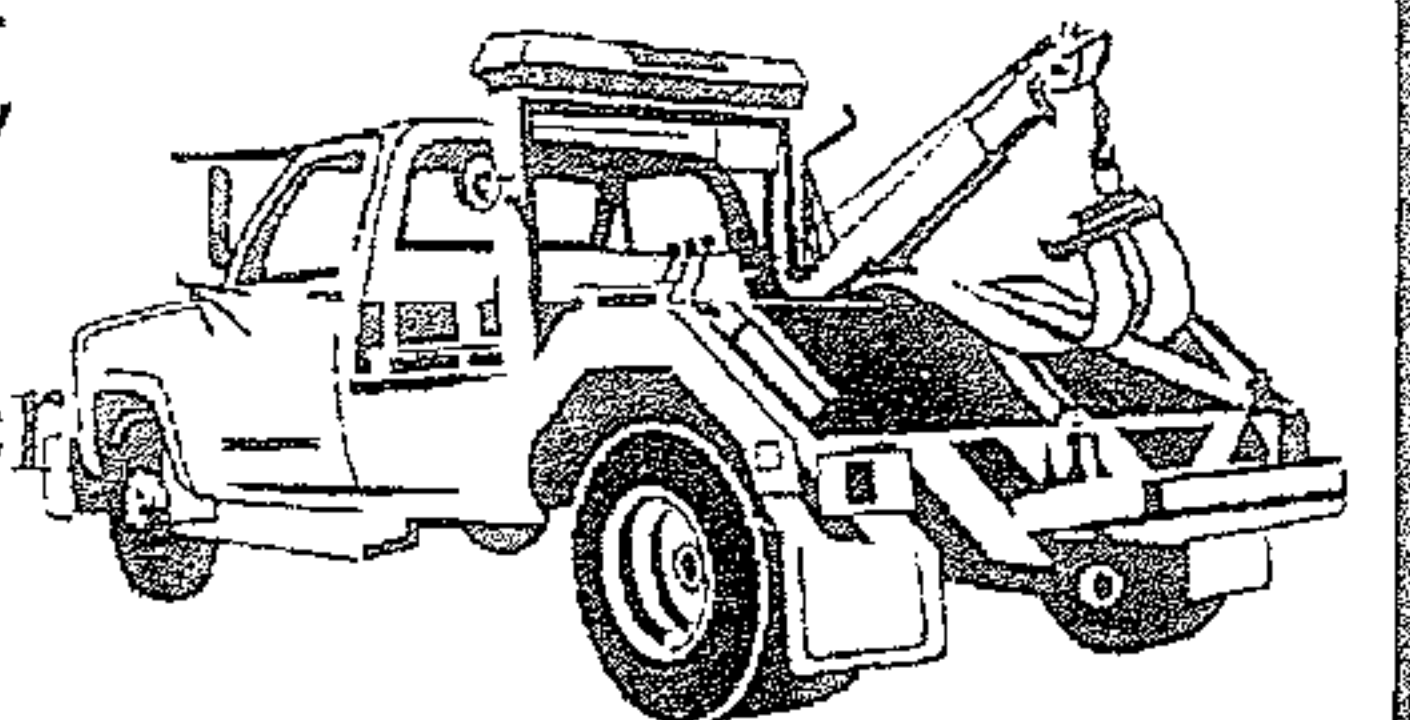

BIMBO'S

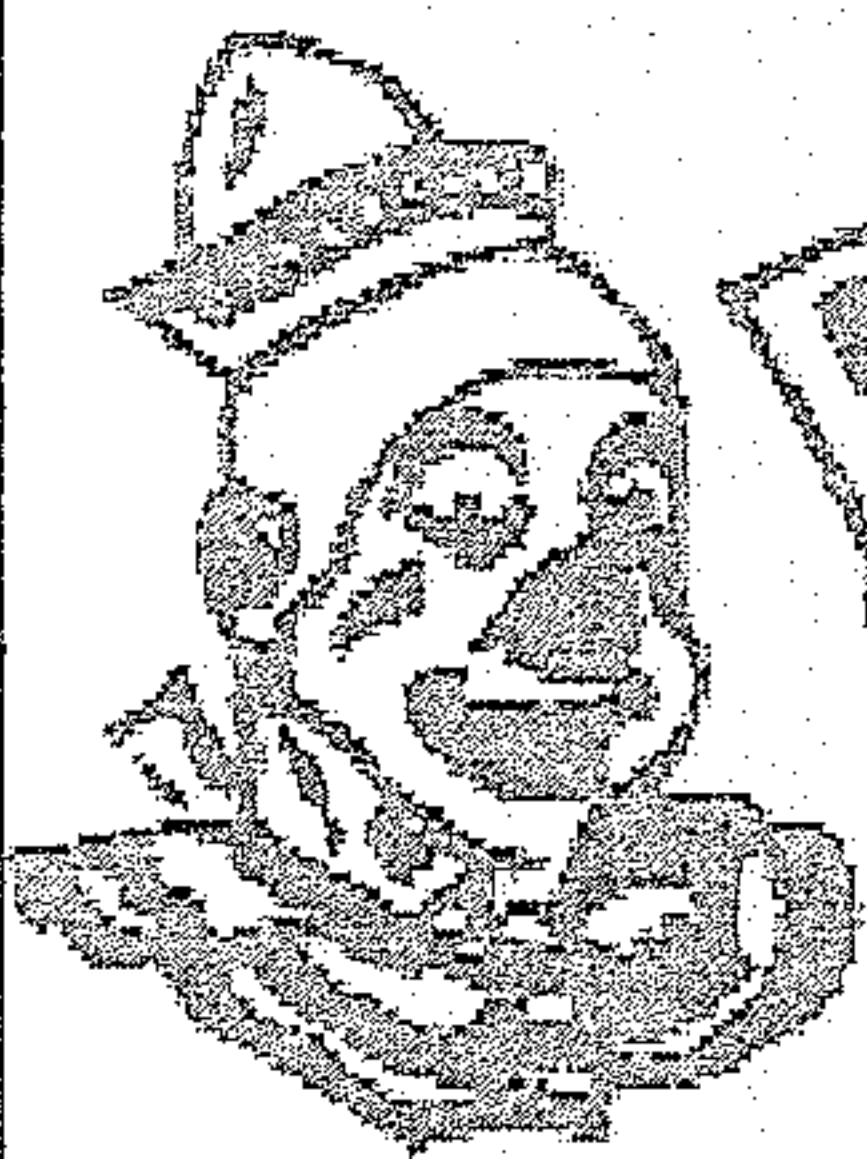

Deli Open 24 Hours

865-986-9643 Call Ins Welcome

Specials

Lg. Cold Sub, bag of chips and 16 oz. fountain drink only \$6.29

Footlong Corn Dog \$2.59

bill

The change comes as part of a package deal. The heart of the bill was actually centered on enhancing the state's DUIs laws.

Current law hands out a Class E felony to any person with four or more DUI convictions. The bill would alter the state's law and give a Class C felony to anyone with six or more DUI convictions.

According to the bill's fiscal note, Tennessee annually averages about 456 convictions for four or more DUIs. If the changes proposed in the bill were implemented, the state's correction system would increase by 61 people, including estimates for population growth.

Factoring in recidivism rates, the fiscal note found that the

state could reasonably expect 34 additional offenders, which would cost \$1.6 million, to enter Tennessee's correctional system each year as a result of the DUI changes.

With that in mind, the bill's sponsors — Sen. Randy McNally, R-Oak Ridge, and Rep. William Lamberth, R-Cottontown — amended it to include the changes to

the state's prosecution of offenses involving the possession of controlled substances.

Passage of the bill would actually result in a \$342,600 decrease in incarcerations, according to the fiscal note.

"In order to reduce the fiscal effects of the bill it does reduce the simple possession or casual exchange of a controlled substance,"

McNally said while introducing the bill.

Simple possession is when someone has an illegal substance and they don't possess it for delivery or sale, said Brent Cooper, District Attorney General for the 22nd Judicial District.

"Typically, 99 percent of the time, it's

possessed for personal use," he said.

When asked whether he supports the legislation, Cooper said although he only recently heard about the bill, a colleague of his was in favor of it.

The bill was also amended by Sen. Brian Kelsey, R-Memphis, who sought to make (see bill ctd. pg. 5)

Now ABOUT \$50 YOU DIDN'T HAVE BEFORE?

Just come to Liberty Tax, let us do your taxes and we'll hand you \$50 cash on the spot.

119 E. Broadway Street
Downtown Hwy 11
820 Hwy 321 N
Across from Burger King

LIBERTY TAX SERVICE
Lenoir City, TN 37771
865-986-8335

with paid tax preparation. Valid at participating locations. Cannot be comined with other offers or used toward past services. One coupon per return. Expires 2-15-15

APPLY FOR AN EASY ADVANCE AND GET MONEY FAST!

\$750 Easy Advance at Liberty Tax at No Additional Cost!

820 Hwy 321 N 119 E. Broadway Street
Across from Burger King Downtown Hwy 11

**Lenoir City, TN 37771
865-986-8335**

An Easy Advance (EA) is a \$750 loan secured by your tax refund and is offered by Republic Bank & Trust Company, member FDIC, to qualifying applicants. There are no fees or interest associated with the EA. Subject to approval. Visit your Liberty office to learn more. Offer Expires 2-28-15.

BUDGET
Transmissions

Why Buy From Budget?

Free Towing From Lenoir City or Loudon County
20 Years of BBB Zero Customer Complaints Award Member
A+ Plus Rated
Huge Transmission Inventory
Best Technicians Period!!!

Call (865) 584-4391 Today!

**302 S. Northshore Drive Knoxville
(865) 584-4391**

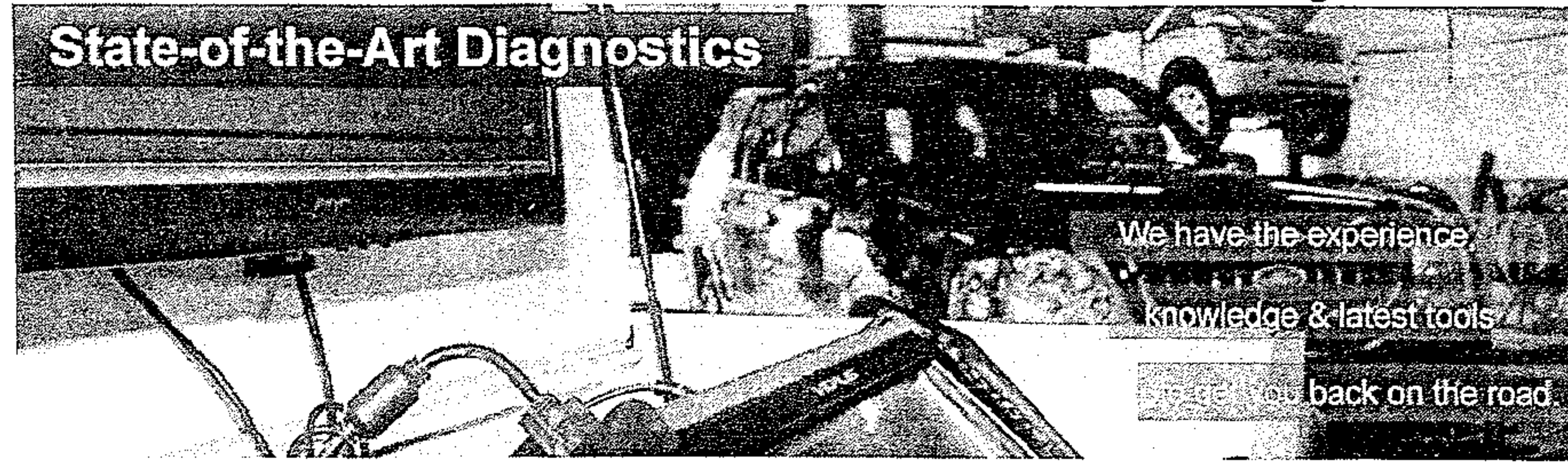
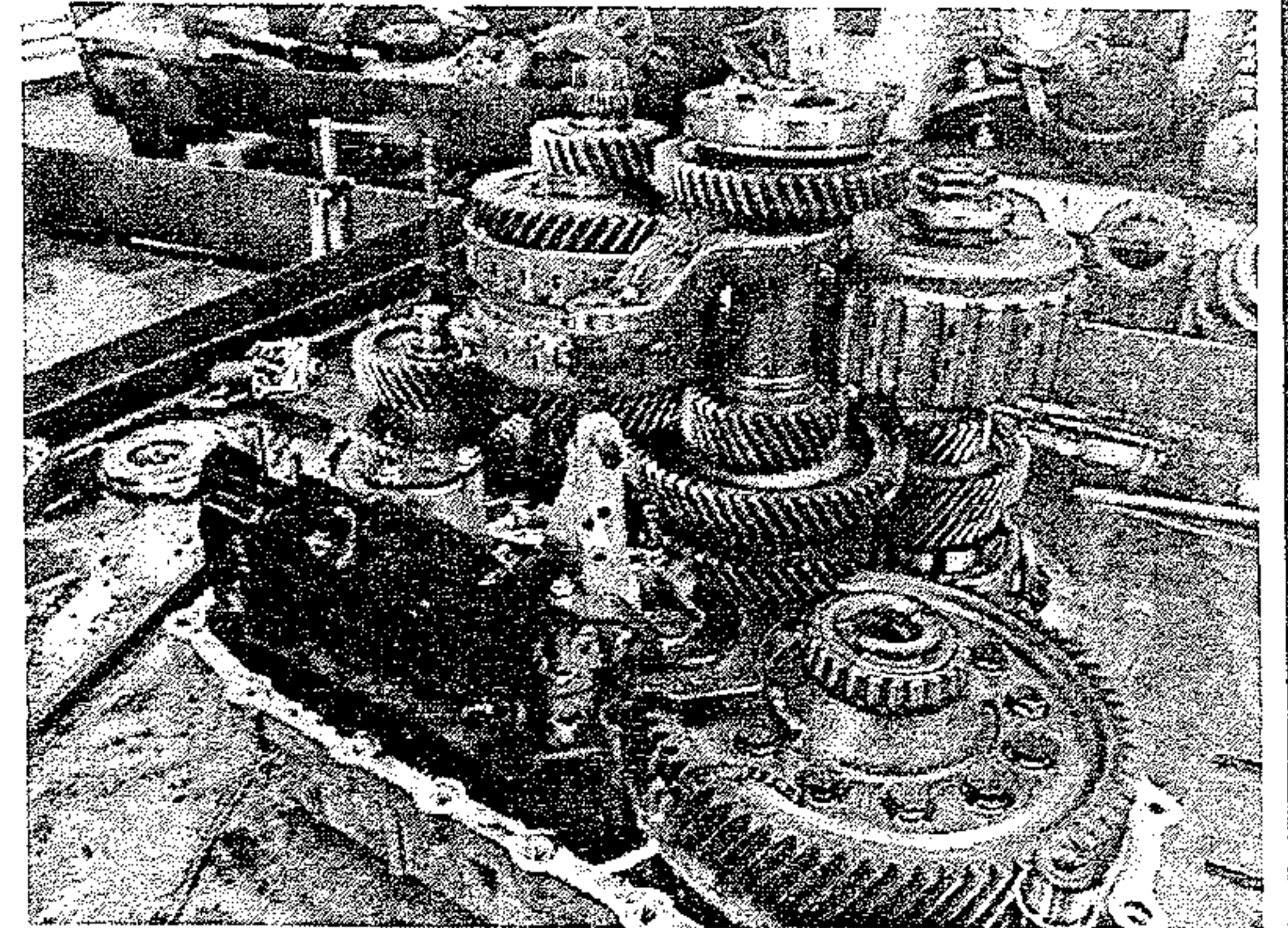

budget-transmissions.com



Approved Auto Repair



DUI
 Jare Barkley, 50, Peach Orchard Maryville, was charged with DUI, Legend Drug, Open Container, Simple Possession, Following Too Close, and Violation Implied Consent. Deputy Brian Smith LCSO, observed a tan vehicle traveling south on Hwy 321. Deputy did observe the vehicle cross the fog line several times then strike a

horse trailer in the rear. Upon stopping the vehicle Deputy identified the driver as Jare Barkley, who had a strong odor of an alcoholic beverage coming from the vehicle. Once Deputy had Jare exit the vehicle Deputy noticed the same odor coming from Jare person. Jare was unsteady on his feet while walking and standing. Deputy noticed spilled beer in the vehicle. Jare did

poorly on sobriety test and was placed under arrest. Upon inventory of the vehicle Deputy located a bottle of Gabapentin, Xanax, and an open beer in the floor board. Deputy Brian Smith LCSO, made the arrest.

fraud supervised release and ordered Schmidt to pay full restitution to his victims and a \$100 special assessment.

Schmidt pleaded guilty in September 2015 to wire fraud. According to information included in documents on file with U.S. District Court, Schmidt devised and executed a Ponzi type investor scheme which defrauded 30 individuals of approximately \$744,000, over a six-year period of time. He falsely convinced his victims that they were investing in Ton-

er Depot, a business which had contracts with Tennessee Eastman Company.

Agencies involved in this investigation included the Tennessee Bureau of Investigation, Morristown, Tennessee Police Department, and Jonesborough, Tennessee Police Department. Suzanne Kerney-Quillen and Helen Smith, Assistant U.S. Attorneys represented the United States.

bill ctd. from pg. 4

changes to those convicted of carjacking.

Kelsey noted that under current law, offenders convicted of carjacking can serve as little as 30 percent of their sentence before being released on parole.

His amendment, which was adopted by the committee, sought to require any person convicted of carjacking to serve 75 percent of the sentence imposed by the court, minus any earned and retained sentence credits. Kelsey's amendment does not allow the service credits to reduce the time served below 60 percent.

While some on the committee, including Sen. Douglas Overbey, R-Maryville, were hardly enthusiastic about the changes to the prosecution of those in possession of marijuana, it was seen as a necessary compromise due to financial reasons.

"The trade-off is to strengthen our laws against driving while intoxicated to those

(see bill ctd. pg. 7)

PURDY'S AUTO PARTS AND SALVAGE

WE BUY SCRAP IRON • COPPER • BRASS • ALUMINUM

\$

Paying Top \$\$\$

Call For Latest Prices

You Name It, We Buy It!

Radiators, Wheels, Batteries, Appliances, Farm Equipment

Copper

Paying Top \$\$\$

Call For Latest Prices

You Call We Haul!

423-519-5402



* Prices subject to change with the market.

423 337-3977

149 County Road 323 Sweetwater

Complete Cars

per 100 lbs.

Scrap Metal

Paying Top \$\$\$

Call For Latest Prices

per 100 lb

We Buy Batteries

Aluminum Cans

Paying Top \$\$\$

Call For Latest Prices

**Now Selling
 Aftermarket
 Body Parts at
 Discount Prices**

* Prices subject to change with the market.

theft

Bobby Bell, 34, Duncan Ave Chattanooga, was charged with Theft of Property.

Steven Brannan, 33, Chadwick Way Blaine, was charged with Theft of Property.

Officer Brandon Johnson LCPD, responded to Walmart for a theft call. Walmart Loss Prevention observed Bobby Bell take possession of a shopping cart full of unpaid merchandise from an unknown female. Bobby pushed the cart through the register line without paying. Bobby passed the shopping cart off to Steven Brannan, who exited the store with the merchandise with-

out paying. Merchandise total was \$856.59. Officer Brandon Johnson LCPD, made the arrest.

bill ctd. from pg. 5

that are the most grievous offenders and those that are most likely to cause serious bodily injury or death on the highways," Overbey said.

After the committee concluded its discussion on the bill and ultimately voted in its favor, the conversation was moved to another bill aimed at making changes to the prosecution of marijuana possession.

But that bill, sponsored by Sen. Jeff Yarbro, D-Nashville, was ultimately cast aside.

Yarbro's bill focused on making changes to the prosecution of marijuana possession and did not include the DUI enhancements that McNally's bill did.

Yarbro argued that McNally's bill would not only make those convicted of possessing marijuana three times or more guilty of a misdemeanor, it would do the same for cocaine, methamphetamine and heroin.

But several senators said they were against Yarbro's bill.

"I favor Sen. McNally's approach with the third conviction not being a felony for simple possession," said Sen. John Stevens, R-Huntingdon. "Under your bill, they

will still be felons potentially if they have controlled substances, not marijuana, in small amounts."

Sen. Mike Bell, R-Riceville, laid out his reasons for opposing Yarbro's bill, saying, "Lessening the punishment for the crime

gave me some heartburn. But with the previous bill I got a little sugar with the bill that helped the medicine go down. With this bill I don't."

Yarbro encouraged the committee to pass his bill in the event that Mc-

see bill conc. pg. 8

JOB OPENING

Loudon County Habitat for Humanity Home Store has an opening for an Associate. This 30-hour a week position provides services related to the pickup of donated goods outside the store, and the movement of donations in the store. Assists with scheduling, determining routes, and driving the store truck. Must be able to lift 50 pounds and be able to read a map and follow directions. Must have a valid driver's license. Must be adaptable to rapidly changing conditions and have good interpersonal skills. Applications available at the store T-F 9:00-5:00 and Sat. 8:00-1:00. 303 Simpson Road East, Lenoir City. Drug Free Workplace - EOE

LOOK! \$75 Weekly Payments LOOK!

MARTY'S AUTO SALES • 986-2222 • MARTY'S AUTO SALES • 986-2222 • MARTY'S AUTO SALES • 986-2222 • MARTY'S AUTO SALES • 986-2222 • MARTY'S AUTO SALES •

Bad Credit
Divorce
Fixed Income
Repos
Bankruptcy
No Credit

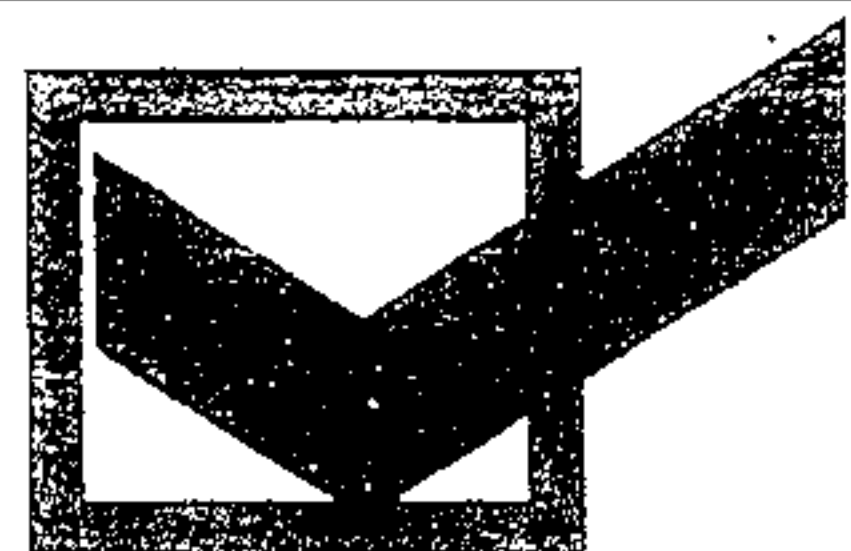

APPROVED!

Visit Us On The Web At:
martysautosales.net

NO CREDIT CHECKS

\$499 down*

07 Cobalt, 5spd, gas saver, runs great Only \$499 down*

\$299 down*

99 Solara, V6, auto, sporty, Only \$299 down*

\$599 down*

04 Santa Fe, auto, Nice, clean. Only \$599 down*

\$499 down*

01 Sebring 2dr. sporty, Only \$499 down*

\$499 down*

05 Sedona, Runs Great, Only \$499 down*

\$399 down*

01 Rodeo, 4cyl, 5spd, Gas Saver Only \$399 down*

\$499 down*

99 Grand Cherokee, Loaded, 1thr, Only \$499 down*

\$99 down*

98 Bonneville, 6 cyl, Auto, low payments only \$99 down*

NO Credit Checks

Marty's Auto Sales
986-2222

Se Habla Espanol

100% Approval

*See Dealer for details. All down payments plus tax, tag, title and fees.

MARTY'S AUTO SALES • 986-2222 • MARTY'S AUTO SALES • 986-2222 • MARTY'S AUTO SALES • 986-2222 • MARTY'S AUTO SALES • 986-2222 • MARTY'S AUTO SALES •

bill conc. from pg. 7

Nally's legislation were to fail to make its way through the Senate and House. But Yarbro ultimately agreed to place his bill on the committee's last calendar. The move allows Yarbro to bring his bill back before the committee in case it is necessary.

With the committee's action, McNally's bill is now headed to the Senate Finance, Ways and Means Committee.

To Advertise
for as low as
\$1 per day
Call
865-771-2249

THE RELIC SHOP

521 Hwy 321 Lenoir City Suite 3
next to Stained Inc and the Inn of Lenoir
865-250-9280

WE ARE IN TUCSON, ARIZONA BUYING UP FOSSILS
FOR THE SHOP. WE NEED TO MAKE ROOM!!!

ALL AMETHYST 40% OFF

GREAT SELECTION OF ANCIENT MEGALADON
SHARK TOOTH OVER 8 MILLION YEARS OLD

Is Your Washer Broken?

Call Me

I Only Charge \$100 Period!!!

Call Allen

865-617-7113

A Name You Already Know And Trust Just Got Even More Dependable
DEPENDABLE AUTO SERVICE, LUBE AND TIRES
is Now Offering
Expert, Affordable Transmission Service

All ASE Certified Technicians

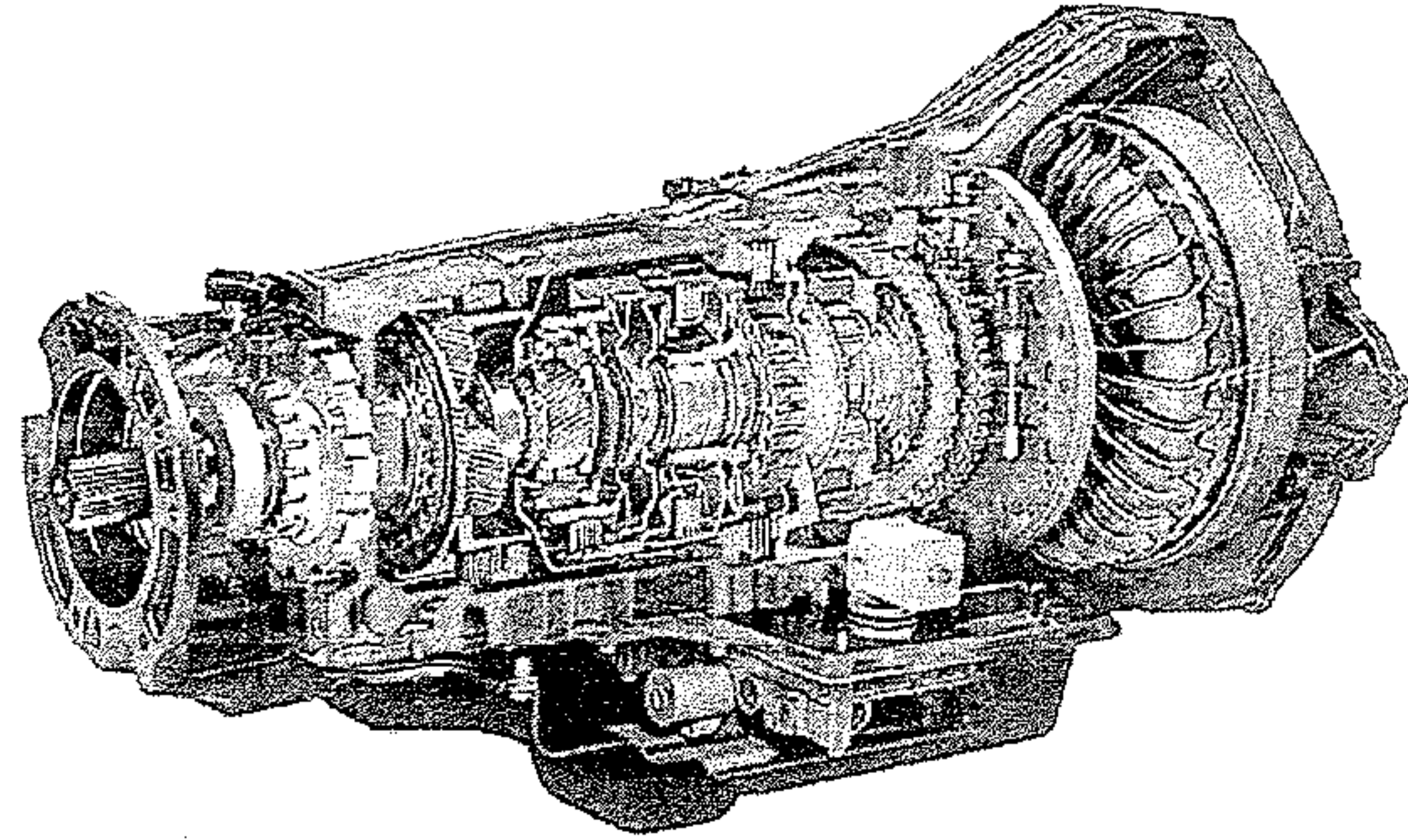

We proudly welcome all New Customers
and Former Advanced Transmission
Customers with a 10% Discount and Any
Transmission Service or Repair*

865-986-9359

865-986-5050

Bad Credit, No Credit OK!!! We Finance Everybody!!!

Taxes Done Here!!! Bring your last pay stub or W2 and DRIVE TODAY!!!

Over 100 Cars, Trucks & Vans in Stock - Warranties On ALL Vehicles Sold!!!

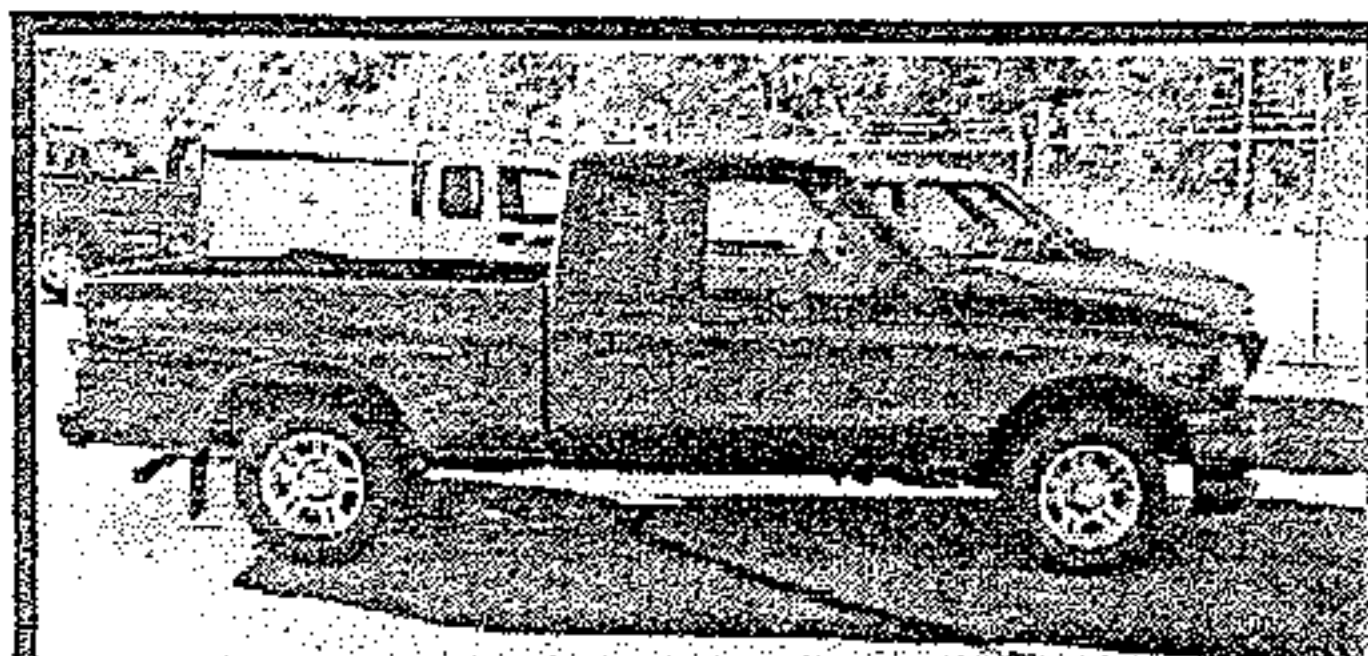

2005 Ford Ranger, Super
Nice Truck, Very Low Miles



2015 Nissan Versa Note, Fac-
tory Warranty, Low Miles

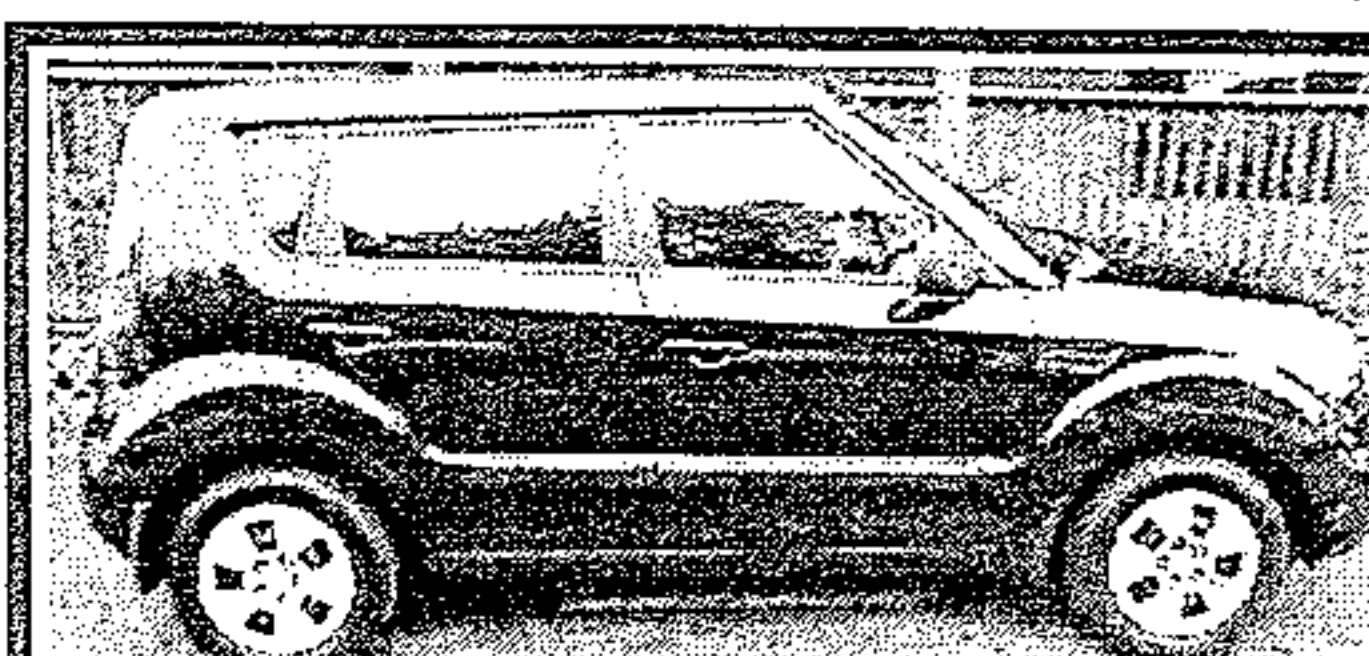

2011 Kia Soul, 5 speed, 4 dr,
Gas Saver, Nice & Clean



2007 Chevy Equinox, 4dr, Extra
Clean, lots of room



2010 GMC Acadia, Leather,
3rd row, sunroof, Loaded

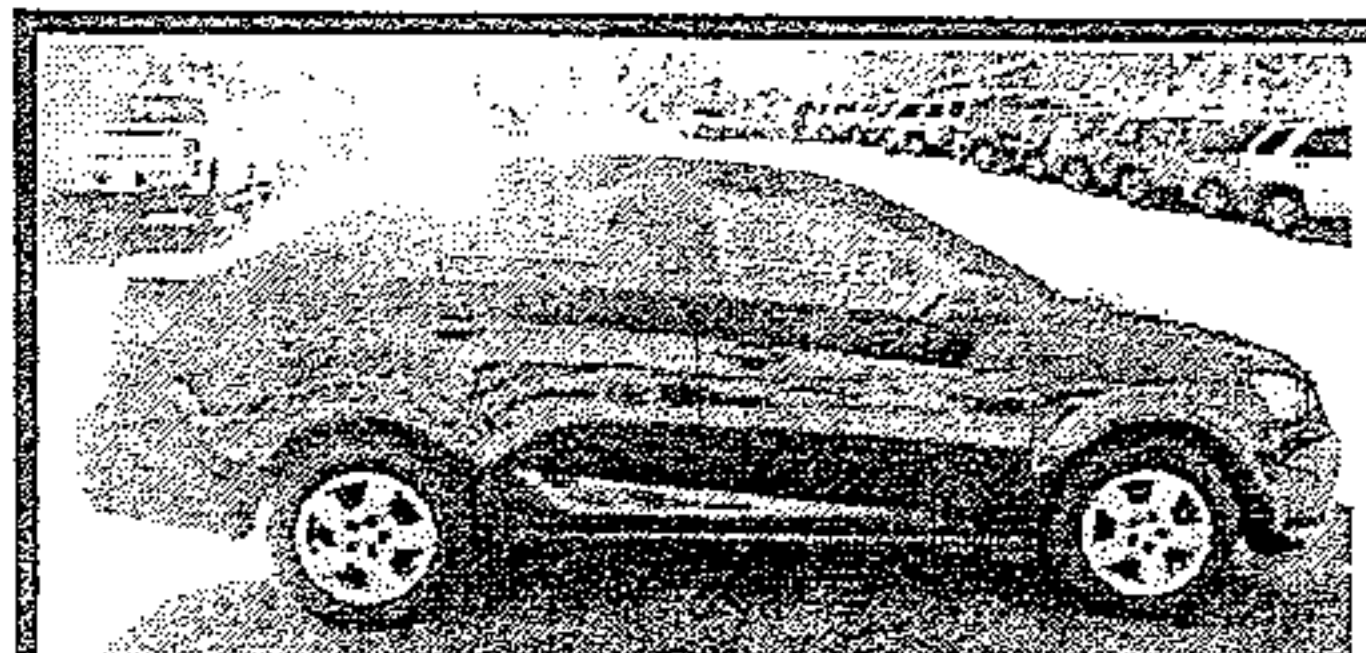

2014 Chevy Sonic, Factory
Warranty, Low Miles!

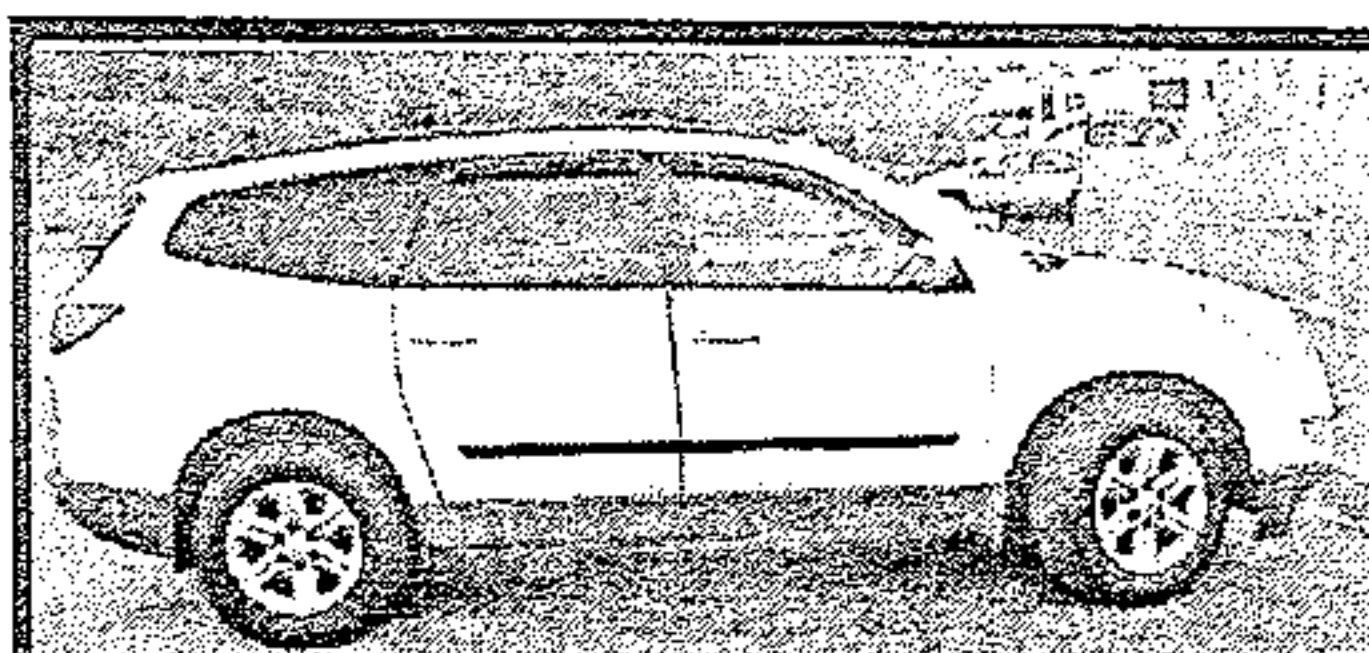

2010 Chevy Traverse, 3rd row
seat, Loaded, Clean

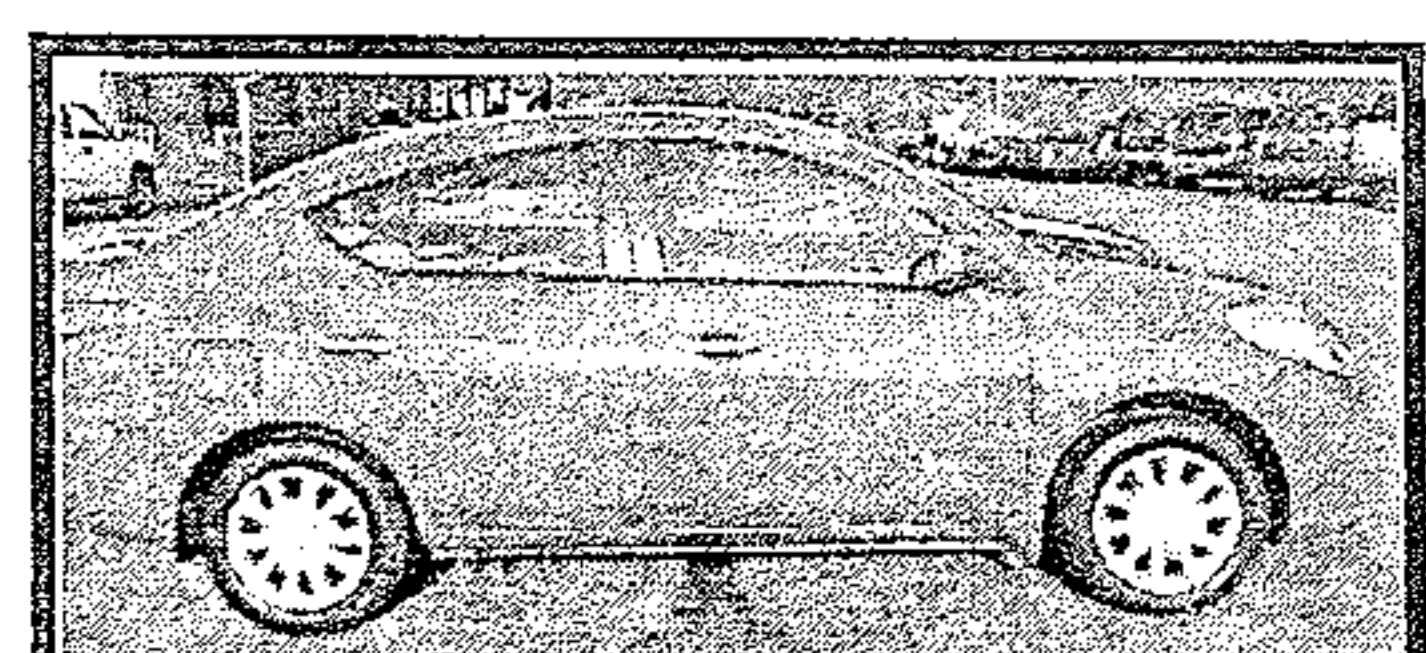

2013 Nissan Versa, Like New!
LOADED!!!

WALT WILLIAMS, INC.

*with approved credit

3003 Highway 11 Lenoir City, TN 865-986-1111