

# The Daily Edition

50¢

Serving Loudon, Monroe and Surrounding Counties

Wednesday, February 3, 2016

## Man charged in 2014 burglary of Dollar General

Kenneth Loveday, 44, East Scott Avenue Knoxville, was charged with Burglary.

On 3/17/14 Kenneth Loveday and a co-defendant did make entry into the Dollar General Store located on Hwy 72 in Loudon, while the store was closed to the public for the purpose of committing theft. Entry was made by prying open a rear door. The incident was captured on the in store video system. Loveday wore a mask

(see burglary pg. 2)

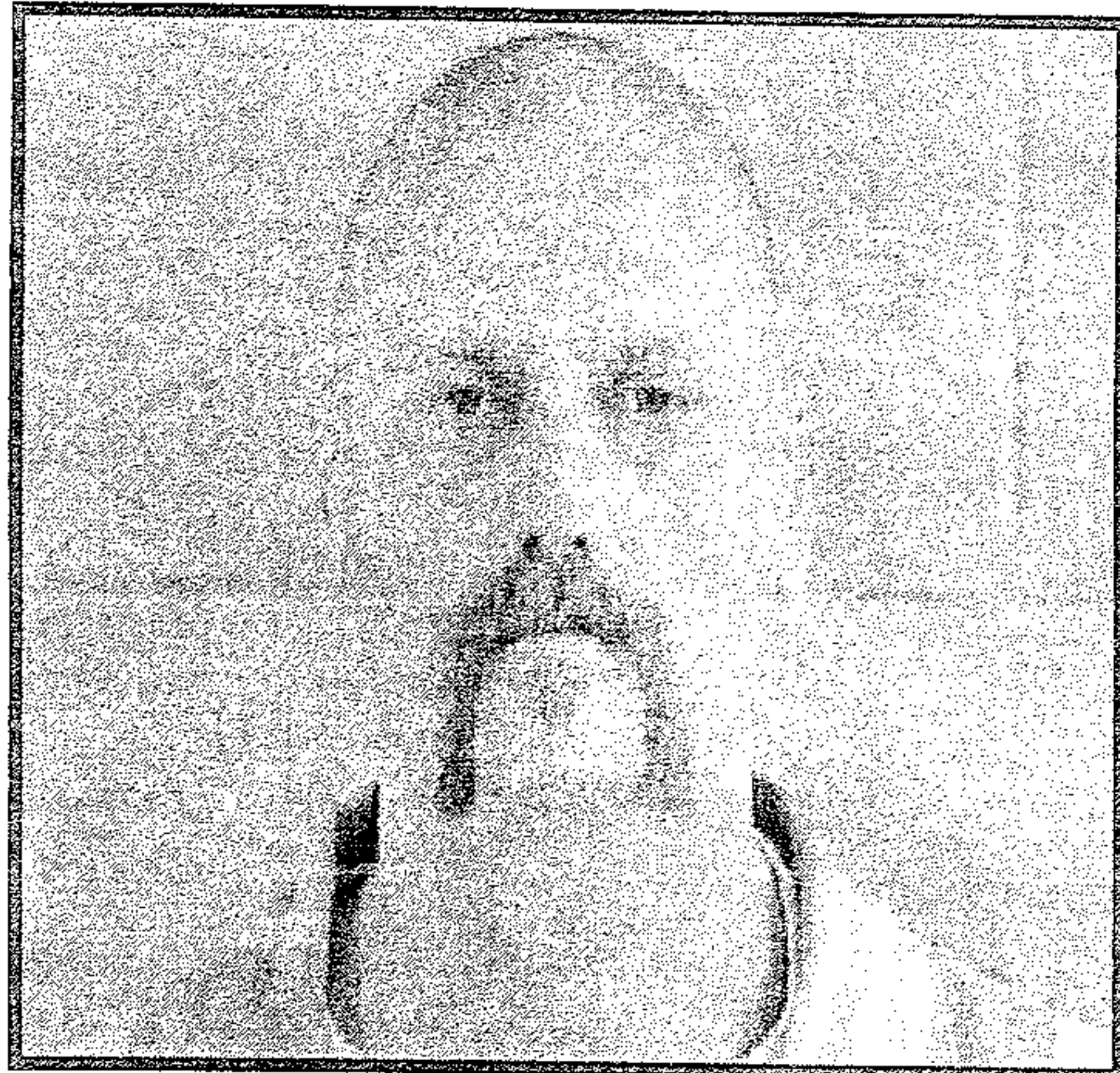

Kenneth Loveday

## Already wanted man resists arrest in LC

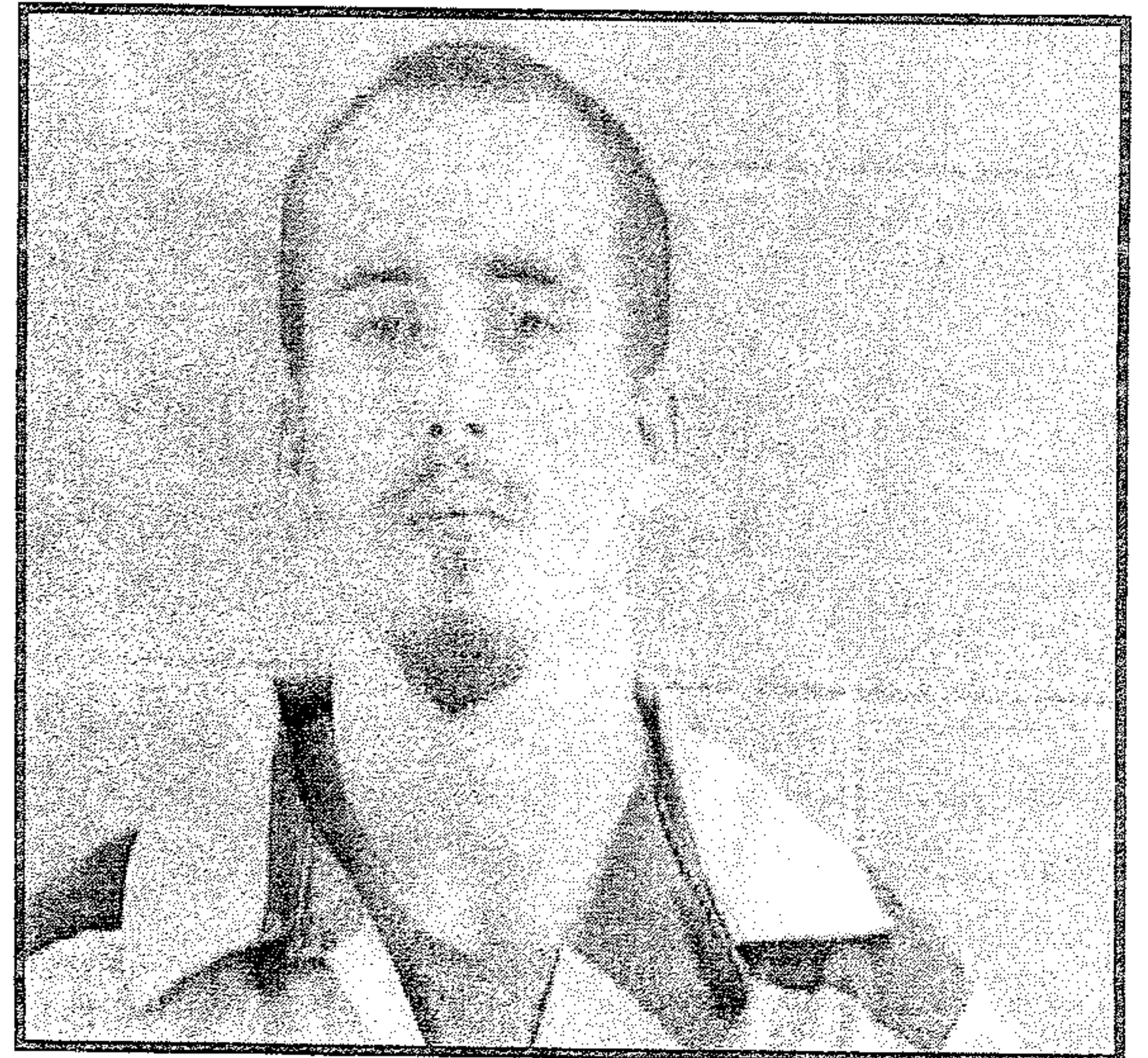

Thomas Cratty

(see Cratty pg. 5)

## Wing trip gets wild; one charged

Devin Hundley, 31, Town Creek Road W Lenoir City, was charged with Domestic Assault, and Vandalism. Deputy Ben Everett LCSO, received a call from dispatch of a subject trying to get in the residence of Town Creek Road. On the way to the scene dispatch advised Deputy that the subject had kicked in the door and was inside

(see DV pg. 7)



Devin Hundley

2 Florida brothers sentenced to 84 months in prison for bath salts and money laundering conspiracies in East TN

Michael Loren Sheaffer, 35, of Pinellas Park, Fla., and Matthew Shawn Sheaffer, 35, of Holiday, Fla., were both sentenced on Jan. 27, 2016, by the Honorable J. Ronnie Greer, U.S. District Court Judge, to

(see brothers pg. 7)

## Benjamin Colby Smith sentenced to 200 months for leadership role in methamphetamine conspiracy

On Jan. 25, 2016, Benjamin Colby Smith, 39, of Russellville, Tenn., was sentenced by the Honorable R. Leon Jordan, U.S. District Judge, to serve 200 months in federal prison for his leader-

ship role in a methamphetamine conspiracy centered in the Morristown area of the Eastern District of Tennessee. Smith obtained substantial quantities of methamphetamine from a source of supply in Georgia and redistributed it to others in and around Morristown, Tenn.

According to Smith's plea agreement on

Library's monthly program, Books Sandwiched In, takes a dissenter's view of climate change

Library's monthly program, Books Sandwiched In, takes a dissenter's view of climate change

Join Renee Hoyos as she discusses Cool It! The Skeptical Environmentalist (see library pg. 3)

**Verse of the Day**  
...you are in Christ Jesus, who has become for us wisdom from God — that is, our righteousness, holiness and redemption. Therefore, as it is written: "Let him who boasts boast in the Lord." — 1 Corin-

thians 1:30-31  
**Obituaries**  
see inside  
**Wazzup**  
Uh Oh! Word has it that the blizzard of 93 may make a repeat! We'll keep ya posted.

### Weather

Today: Rain early. A mix of sun and clouds in the afternoon. High 63F.  
Tonight: Mostly clear skies. Low 34F.  
Thursday A few passing clouds, otherwise generally sunny. High 47F.  
Thursday Night Clear skies.

Low 27F.

### Horoscopes

**Aquarius 1/20-2/19**  
Your dreams seem so close that you might believe you can actually reach out and touch them. However, your friends

(Continued on page 6)

(see sentenced pg. 4)



burglary and gloves while committing this burglary. On 3/23/14

Loveday were encountered by a Knoxville Deputy, while he was responding to a burglary.

Loveday had in his possession a red pair of gloves, a dark ski mask, gray sweat-shirt with wording on the front, a small blue pry bar with a white sticker on it and a long pry bar with a white sticker on it.

All these items were identical to the one in the video of the burglary at the Dollar Store.

Deputy Eric Curtis LCSO, arrested Kenneth Loveday at the Knox. Co Jail on 1/26/16 for this charge.

## Public Notice

The Loudon County Corrections Partnership Committee will meet February 10th, 2016 at 12:00 at the Justice Center to discuss future plans.

## HACIENDA Ayala's

Mexican Restaurant

Market Dr. \* Lenoir City (In Front of Food City)

Real Authentic Mexican Food at Affordable Prices

BEST MARGARITA

You've Tried The Rest Now Come Have The Best!!!

We Accept ALL Competitors Coupons Outside of Mexico City!

986-3553



Notice: The Daily Edition does not knowingly accept fraudulent or misleading materials. The Daily Edition cannot guarantee the validity of offerings or statements contained herein. All liability for the contents of all advertising, and for any claims that may arise therefrom, is the responsibility of the advertiser or its agency. The Daily Edition reserves the right to reject, edit, or abbreviate any advertisement submitted. Advertising is accepted with the understanding that all liability for all copyright violations is the sole responsibility of the advertiser.

Photographs, artwork and other copy submitted for publication is considered the sole property of the advertiser. The Daily Edition will make every effort but will not be liable for failure to publish and ad or for typographical and layout errors. All statements and information about highlights featured items, letters to the editor, herein are those solely given to the interviewer or writer and the Daily Edition assumes no responsibility of the accuracy or validity thereof. The Daily Edition will gladly reprint at no charge that part of an advertisement in which an error occurs provided a claim is made within 3 days of the first publication of the ad. Information contained in the Wazzup is received anonymously and the Daily Edition assumes no responsibility for information and reserves the right to edit or reject any and/or all submissions. The Daily Edition is a daily newspaper of general circulation in Loudon County defined under TCA 2-1-104(a)(13).

The Daily Edition also serves Monroe, Knox, Anderson, Roane and Blount counties and serves 30,000 readers weekly. Send mail to PO Box 1240, Lenoir City TN 37771. 865-771-2249. email: dan1204us@yahoo.com

The Daily Edition is Loudon County's premier public interest and paid advertising paper. The Daily Edition is produced and published daily Monday through Friday and is circulated throughout Loudon County and parts of Monroe and Knox Counties. Display advertising rates \$5.00 per column inch and quantity discounts available. Call for information on upcoming promotions and events.

## Good Credit OK • Bad Credit OK • Bankruptcies OK • Repo OK



2010 Kia Soul Sporty, 4 cyl, Auto, PW, PL, A/C, Great On Gas, Like New



2010 Ford Escape Limited Leather, Alloy Wheels, Heat, A/C, Luggage Rack, 79K,



2007 Dodge Ram 1500 Quad Cab, Thunder Road PKG, 20 in. Wheels, Low Miles, Hemi



2008 Ford Explorer 84k, 3rd Row Seating, Luggage Rack, Tow Pkg, PW, PL



2011 Ford Ranger Low Miles, Tow Pkg, New Tires, A/C, Heat, Bed Liner.



2011 Dodge Grand Caravan DVD, Stow & Go, Loaded, Remote Doors, Rear A/C

# DEPENDABLE MOTORS 986-9343

803 E. Broadway • Lenoir City

Serving Loudon County for 20 Years

\* WAC. See Dealer for details

Visit our website at: [www.dependablemotorslc.com](http://www.dependablemotorslc.com)

**Library**

ist's Guide to Global Warming by Bjørn Lomborg

Knox County Public Library invites you to join Renée Hoyos, Executive Director of Tennessee Clean Water Network, for a discussion of Cool It! The Skeptical Environmentalist's Guide to Global Warming by Bjørn Lomborg at noon on Wednes-

day, February 17 in the East Tennessee History Center auditorium at 601 South Gay Street at Books Sandwiched In, a program series sponsored by the Friends of Knox County Public Library.

In Cool It!, Lomborg takes a conservative approach to the issue of climate change, arguing that many of the elaborate and expensive actions now being considered to meet the challenges of global warming ultimately will have little impact on the world's temperature. He suggests that rather than focusing on ineffective solutions that will cost trillions of dollars over the coming decades, we should be looking for more cost-effective approaches that will allow us to deal not only with climate change but also with other pressing global concerns, such as malaria and HIV/AIDS. He also considers the demonization of dissenters. And he claims that rather than being endangered, polar bear numbers are actually going up.

Hoyos has overseen the growth of TCWN during her tenure as executive director from an average budget of \$150,000 to \$750,000. She has directed and created programs from

litigation to environmental health and has expanded the brand of TCWN from a small non-profit to a leading voice for the environmental community in Tennessee. Hoyos previously worked with the California Resources Agency and served as Special Assistant to Secretary Mary D. Nichols for Watersheds and Outreach. She holds a Master's degree in Agriculture and Management as well as a Master's of Avian Science degree, both from the University of California in Davis.

Hoyos enjoys rafting, hiking, kayaking and skiing. She is a member of the National Ski Patrol and does weekend patrols at Cata-

loochie Ski Ranch in Maggie Valley North Carolina. Currently, she is a board member of the Knoxville Transportation Authority, the Historic Bijou Theater and a founding board member of the Community Health Alliance.

The series will continue on March 23 when Dr. Suzie Allard, Associate Dean for Research in UT's School of Information Sciences, discusses Big Data: A Revolution That Will Transform How We Live, Work, and Think by Viktor Mayer-Schönberger and Kenneth Cukier. On April 27, Pastor Christopher R. Battles, Sr., Taberna- (see library ctd. pg. 4)

**For Sale: oak Wood Mulch**



Mushroom Compost Topsoil.



Firewood

Call Steve Spoon  
986-4282

**West End Storage & Warehouses**  
502 Ward Avenue • Loudon  
Call 865-458-4774 or 865-679-5555

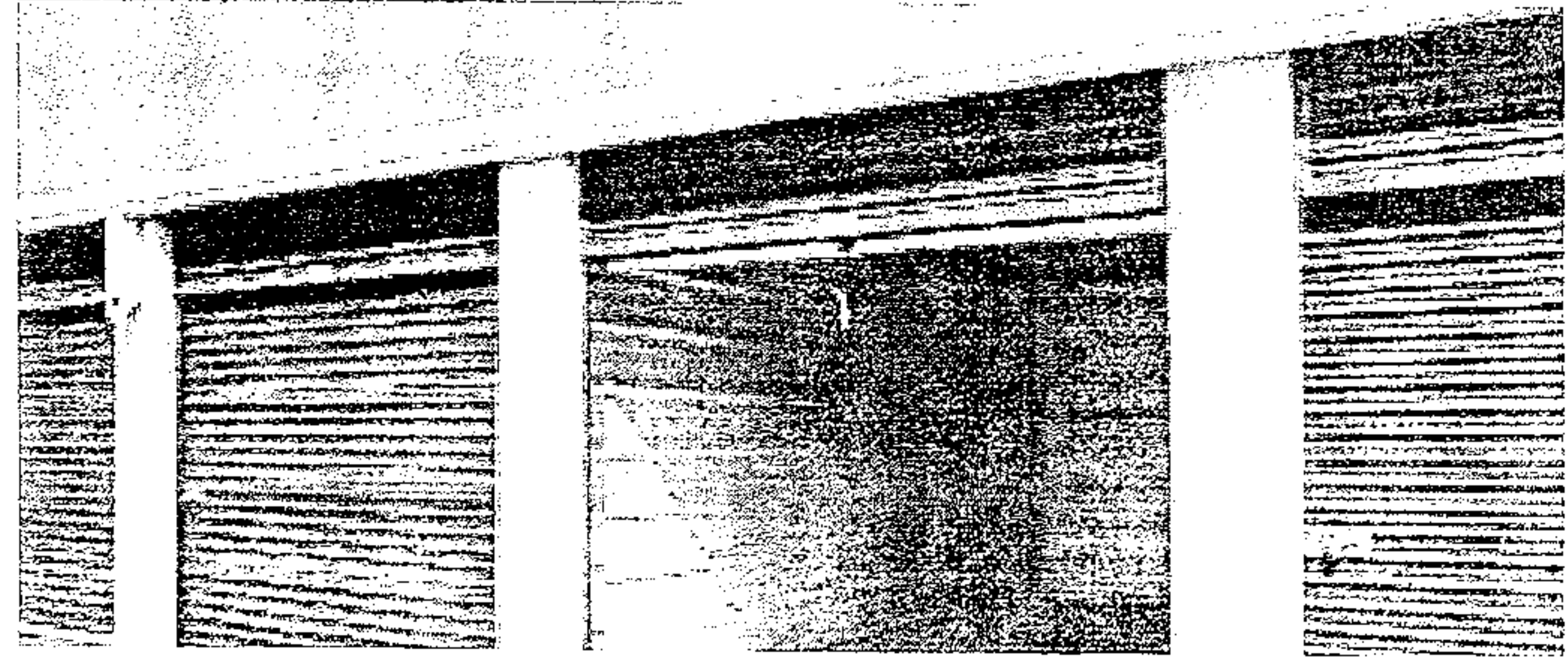

**STAINED INK**

**TATTOO & PIERCING**  
LENOIR CITY 865 816-6440  
NEW OWNER • NEW ARTIST • SINCE 2011  
521 Hwy 321 next to Vape & Stuff & Inn Of Lenoir!  
Clean-Affordable-Quality-Custom  
Tattoo's You've Always Wanted!

BRING IN THIS Ad FOR **\$25 OFF!**  
NEW INK FOR NEW CUSTOMERS ONLY!

Check us out on FB.com/  
Stained.Inc.Tattoo/  
www.STAINEDINC.com

**C&J Towing and Recovery**

**LOWEST TOWING RATES AROUND!!!**

Have you been overcharged for any type of towing service in the Lenoir City area? If you have a breakdown or accident please OWNER REQUEST C&J Towing with the officer. Also please call your Sheriff and ask him to place C&J Towing on the "Rotation List\*" and help other motorists save as much as you did! We at C&J are locally owned and operated, State approved, licensed, bonded and insured. Call and let us know if your denied service or how we can be of assistance.

\*note: the "Rotation List" is a list of wrecker services that provide service for wrecks, DUI's, breakdowns, etc. and are on an on-call basis for service. This list is approved by the Sheriff.

Cliff Teeters • Owner  
865-809-1661



**BIMBO'S**

Deli Open 24 Hours  
865-986-9643 Call Ins Welcome

Specials

Lg. Cold Sub, bag of chips and 16 oz. fountain drink  
only \$6.29

Footlong Corn Dog \$2.59

sentenced file with U.S. District Court, he was involved in a traffic stop in Morristown in September 2014. This stop led to the search of the vehicle he was driving and resulted in the seizure of approximately 45 grams of methamphetamine. Smith was arrested and transported to jail. While incarcerated, he made a number of calls, which were recorded. During some of these calls, he directed Stacy Margarita Williams, 24, and Krystal Ann Sexton, 34, both of Morristown, Tenn., to travel to Georgia and meet with his methamphetamine supplier on his behalf.

In September 2014, Williams and Sexton arrived in Georgia, met with Smith's source and obtained meth-

amphetamine which was to be returned to Tennessee to sell for Smith. On the return trip to Morristown, Williams and Sexton were pulled over for a traffic stop in Georgia. A search of their vehicle resulted in the seizure of at least approximately 51 grams of methamphetamine, a digital scale and a firearm.

Others who were

charged and previously sentenced in this prosecution include Williams, Sexton and Cary Ann Winegar, 38, of Morristown, Tenn., who were sentenced to 60 months, 103 months and 97 months, in federal prison respectively.

Law enforcement agencies participating in this investigation included the Morristown Police Depart-

ment, Hamblen County Sheriff's Office and Franklin County, Georgia Sheriff's Office. Assistant U.S. Attorney Wayne Taylor represented the United States.

Library ctd from pg. 3  
cle Baptist Church and Chris Woodhull, former Knoxville City Councilman, will discuss Between the World and

Me by Ta-Nehisi Coates. On May 25, The Honorable Pamela Reeves, United State District Court, will discuss Sisters in Law: How Sandra Day O'Connor and Ruth Bader Ginsberg went to the Supreme Court and Changed the World by Linda Hirshman. On June 22, Dr. Annette Mendola, UT Department of Philosophy, will discuss Being Mortal: Medicine and What Matters in the End by Atul Gawande.

### HOW ABOUT \$50 YOU DIDN'T HAVE BEFORE?

Just come to Liberty Tax, let us do your taxes and we'll hand you \$50 cash on the spot.

119 E. Broadway Street  
Downtown Hwy 11  
820 Hwy 321 N

Across from Burger King



Lenoir City, TN 37771  
865-986-8335

with paid tax preparation. Valid at participating locations. Cannot be combined with other offers or used toward past services. One coupon per return. Expires 2-15-15

### APPLY FOR AN EASY ADVANCE AND GET MONEY FAST!

\$750 Easy Advance at Liberty Tax at No Additional Cost!

820 Hwy 321 N 119 E. Broadway Street  
Across from Burger King Downtown Hwy 11

Lenoir City, TN 37771  
865-986-8335

An Easy Advance (EA) is a \$750 loan secured by your tax refund and is offered by Republic Bank & Trust Company, member FDIC, to qualifying applicants. There are no fees or interest associated with the EA. Subject to approval. Visit your Liberty office to learn more. Offer Expires 2-28-15.

## PUBLIC NOTICE

The Lenoir City Utilities Board conducts their monthly Board Meetings on the third Monday of every month at 4:00 p.m. The meetings are held in the Council Chambers of City Hall located at 600 East Broadway, Lenoir City, Tennessee 37771. The schedule for 2016 is as follows:

- January 18, 2016
- February 15, 2016 (Cancelled in Observance of President's Day)
- March 21, 2016
- April 18, 2016
- May 16, 2016
- June 20, 2016
- July 18, 2016
- August 15, 2016
- September 19, 2016
- October 17, 2016
- November 21, 2016
- December 19, 2016

**Cratty**

Thomas Cratty, 24, Browder Hollow Road Lenoir City, was charged with Violation of Community Correction, Violation of Probation, and Resisting Arrest. Officer Brandon Gentry LCPD, responded to the Weigels on Hwy 321 @ McGhee Blvd. in reference to Thomas Cratty being on scene. Cratty has 2 active warrants. Officer approached

Cratty inside the store and advised him he had 2 active warrants. At this time Cratty attempted to run around Officer.

The Officer grabbed Cratty around the shoulders, Cratty continued to resist as Officer took him to the ground. Officers were able to get Cratty cuffed and placed under arrest. Officer Brandon Gentry LCPD, made the arrest.

**brothers**

each serve 84 months in federal prison. Both Sheaffers were previously convicted of conspiracy to distribute, and possess with the intent to distribute, assorted Schedule I controlled substances and their analogues; and conspiracy to commit money laundering. There is no parole in the federal system.

Beginning in the

summer of 2010, the Sheaffers began an elaborate criminal business of procuring, marketing, packaging, and distributing massive amounts of Schedule I controlled substances and corresponding analogues. Collectively, these drugs are commonly referred to as bath salts, spice, and synthetic marijuana. However, those names are misnomers used to lure consumers

and avoid criminal liability. In reality, such substances are nothing more than hard drugs masquerading as harmless chemicals.

Utilizing a website and a network of distributors, the Sheaffers sold these drugs throughout the southeastern United States and elsewhere. A large portion of the contraband was distributed from head shops and businesses within the Eastern District of Tennessee. The resulting proceeds were then laundered, funneled back to the Sheaffers and other co-conspirators, and used to further perpetuate their drugs crimes.

A total of five individuals were charged in this case including: Mitchel Lee Chambers, 36, of Magnolia, Tex., who was sentenced to serve 87 months; Niki Lyn Maxwell, 33, of New Port Richey, Fla., who was sentenced to serve 54 months; and, Gretchen Elizabeth Sheaffer, 30, of Pinellas Park, Fla., who was sentenced to serve 54 months.

Acting U.S. Attorney Nancy Stallard Harr said, "Northeast Tennessee has been particularly hard hit by these dangerous, so-called synthetic, drugs. Thanks to the teamwork of our law enforcement partners in the Kingsport Police Department, Sullivan County Sheriff's office, and Johnson City Police Department, as well as the Drug Enforcement Administration (DEA) and Internal Revenue Service,

(see brothers ctd. pg. 7)

**PURDY'S AUTO PARTS AND SALVAGE**

**WE BUY SCRAP IRON • COPPER • BRASS • ALUMINUM**

\$

**Paying Top \$\$\$**

**Call For Latest Prices**

*You Name It, We Buy It!*

*Radiators, Wheels, Batteries, Appliances, Farm Equipment*

**Copper**

**Paying Top \$\$\$**

**Call For Latest Prices**

**You Call We Haul!**

**423-519-5402**

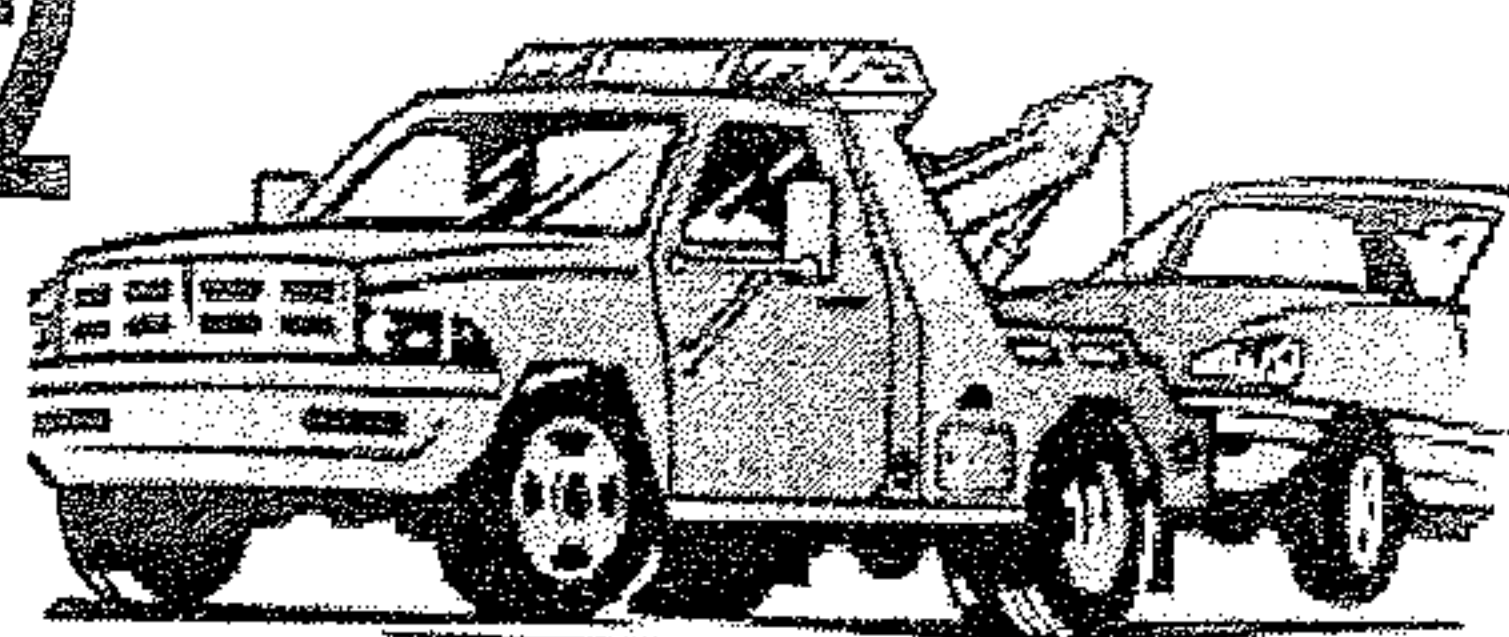

\* Prices subject to change with the market.

**423 337-3977**

**149 County Road 323 Sweetwater**

**Complete Cars**

**per 100 lbs.**

**Scrap Metal**

**Paying Top \$\$\$**

**Call For Latest Prices**

**per 100 lb**

**We Buy Batteries**

**Aluminum Cans**

**Paying Top \$\$\$**

**Call For Latest Prices**

**Now Selling  
Aftermarket  
Body Parts at  
Discount Prices**

\* Prices subject to change with the market.

DV

of the residence. Upon arrival Deputy Brewer saw the suspect leaving the scene in a silver vehicle. Deputy Everett and Brewer stopped this vehicle at Town Creek Road and the Parkway. Devin told Deputy that he had went to a bar with his friend and his girlfriend showed up and dropped their daughter off and left. Devin stated they left and went to Wild Wing and his girlfriend showed up there and took there daughter back to their residence. Devin did kick the door in at the residence and took victim phone and left. It was determined Devin was the primary ag-

gressor and placed under arrest. Deputy Ben Everett LCSO, made the arrest.

brothers ctd. from pg. 5

Criminal Investigation Division (IRS-CI), we were able to react swiftly and decisively to stem the flow of these harmful substances which have no legitimate or legal purpose.”

“The role of Criminal Investigation Division of the Internal Revenue Service in narcotics investigations is to follow the money so we can financially disrupt and dismantle major drug trafficking organizations,” stated Tamera Cantu, Acting Special Agent in Charge, IRS-

CI. “This investigation is a great example of how the various law enforcement agencies in this district work together, and these sentences should send a clear message that drug and money laundering violations are serious crimes that will be punished accordingly.”

This investigation was the product of a partnership between the Kingsport, Tennessee Police Department, Sullivan County Sheriff’s Department, Johnson City Police Department, IRS-CI, and DEA. Assistant U.S. Attorneys M. Neil Smith and Nick Regalia represented the United States.

The investigation

is a result of the Department of Justice’s Organized Crime and Drug Enforcement Task Force (“OC-DETF”) program, the centerpiece of the Department of Justice’s drug supply reduction strategy. OCDETF

was established in 1982 to conduct comprehensive, multi-level attacks on major drug trafficking and money laundering organizations. Today, OC-DETF combines the resources and exper-

see brothers conc. pg. 8

## JOB OPENING

Loudon County Habitat for Humanity Home Store has an opening for an Associate. This 30-hour a week position provides services related to the pickup of donated goods outside the store, and the movement of donations in the store. Assists with scheduling, determining routes, and driving the store truck. Must be able to lift 50 pounds and be able to read a map and follow directions. Must have a valid driver’s license. Must be adaptable to rapidly changing conditions and have good interpersonal skills. Applications available at the store T-F 9:00-5:00 and Sat. 8:00-1:00. 303 Simpson Road East, Lenoir City. Drug Free Workplace - EOE

# LOOK! \$75 Weekly Payments LOOK!

MARTY'S AUTO SALES • 986-2222 • MARTY'S AUTO SALES • 986-2222 • MARTY'S AUTO SALES • 986-2222 • MARTY'S AUTO SALES • 986-2222 • MARTY'S AUTO SALES •

Bad Credit  
Divorce  
Fixed Income  
Repos  
Bankruptcy  
No Credit

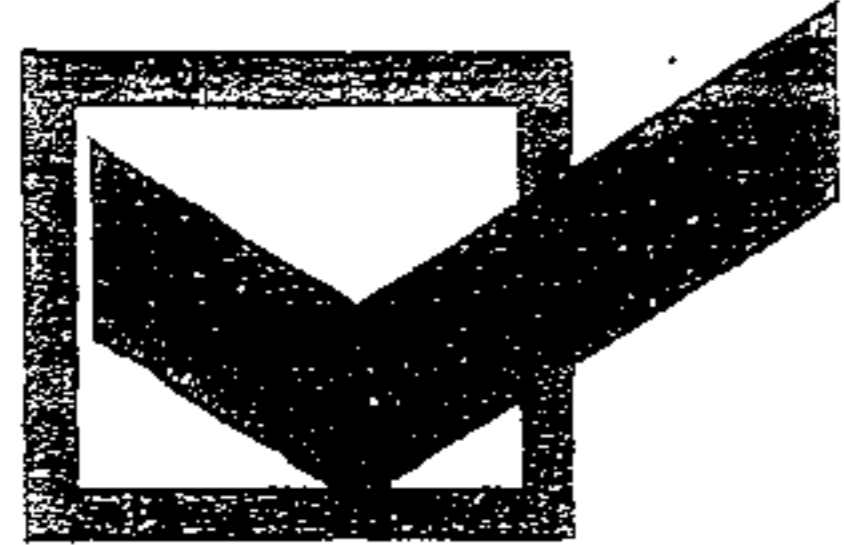

# APPROVED!

NO  
CREDIT  
CHECKS

Visit Us On The Web At:  
[martyautosales.net](http://martyautosales.net)

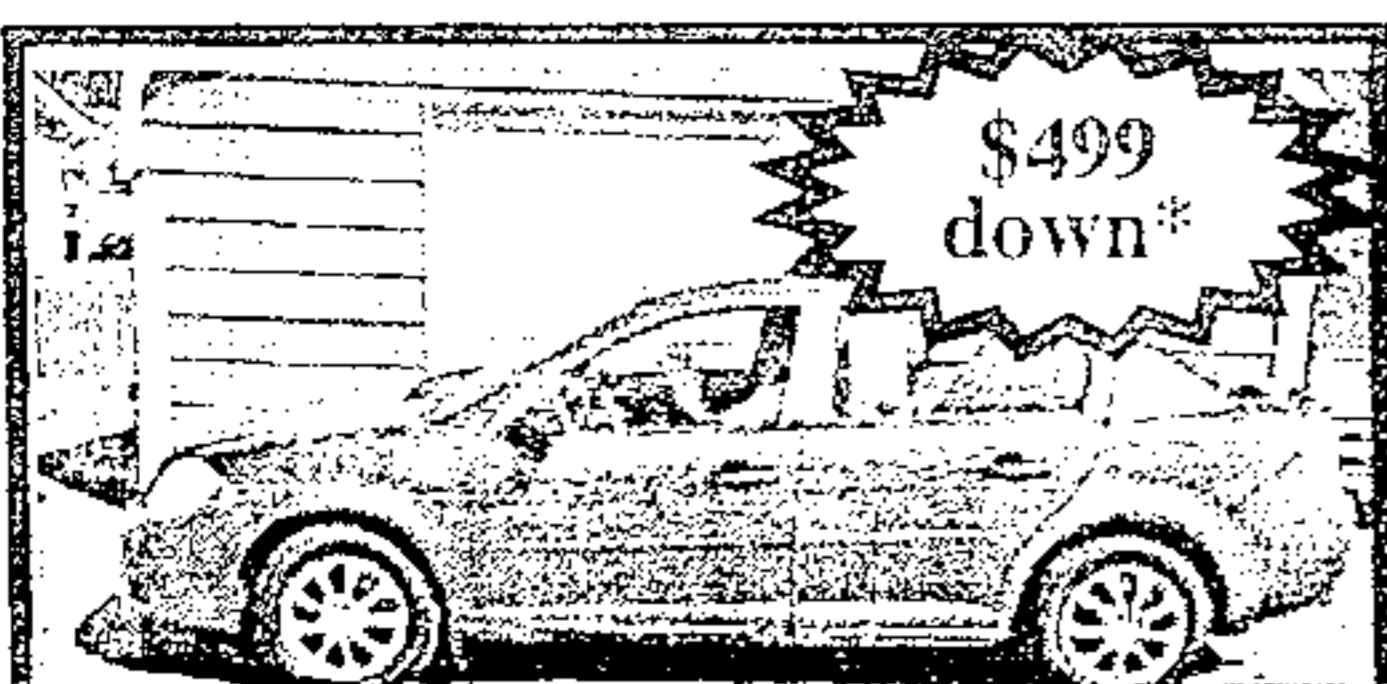

07 Cobalt, 5spd, gas saver, runs great Only \$499 down\*

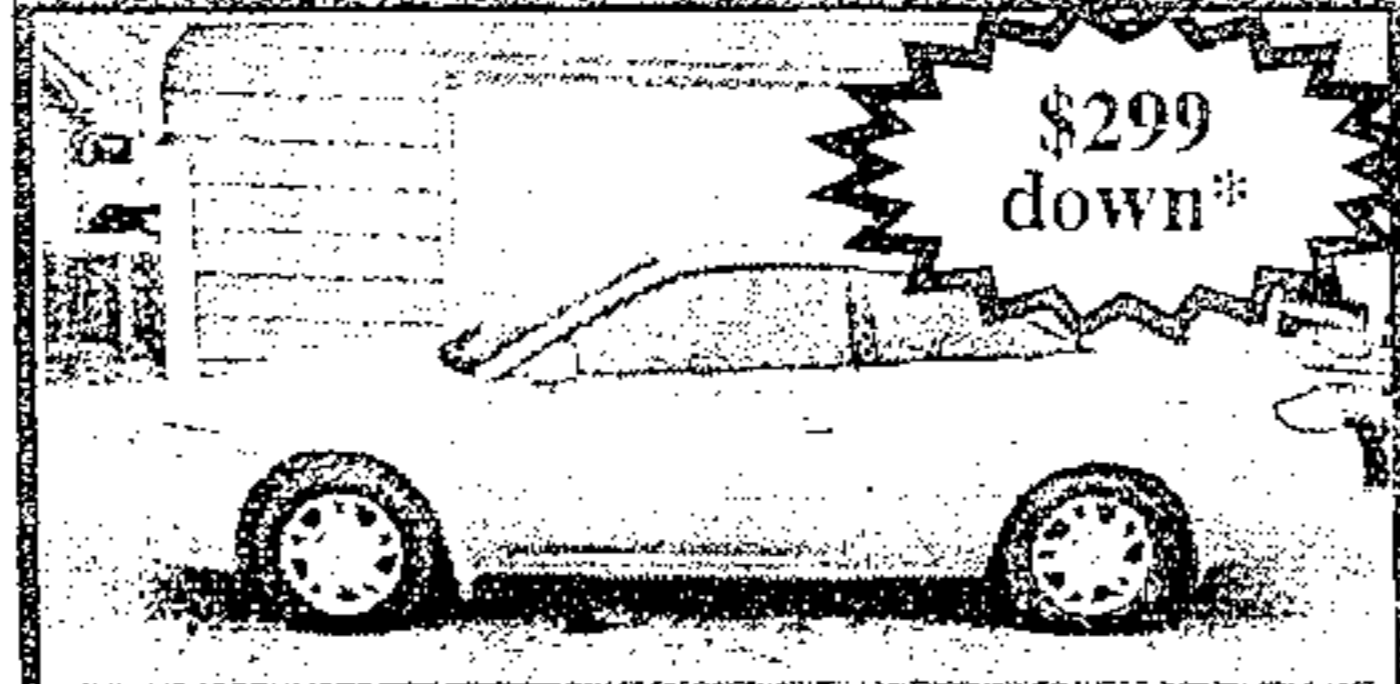

99 Solara, V6, auto, sporty, Only \$299 down\*

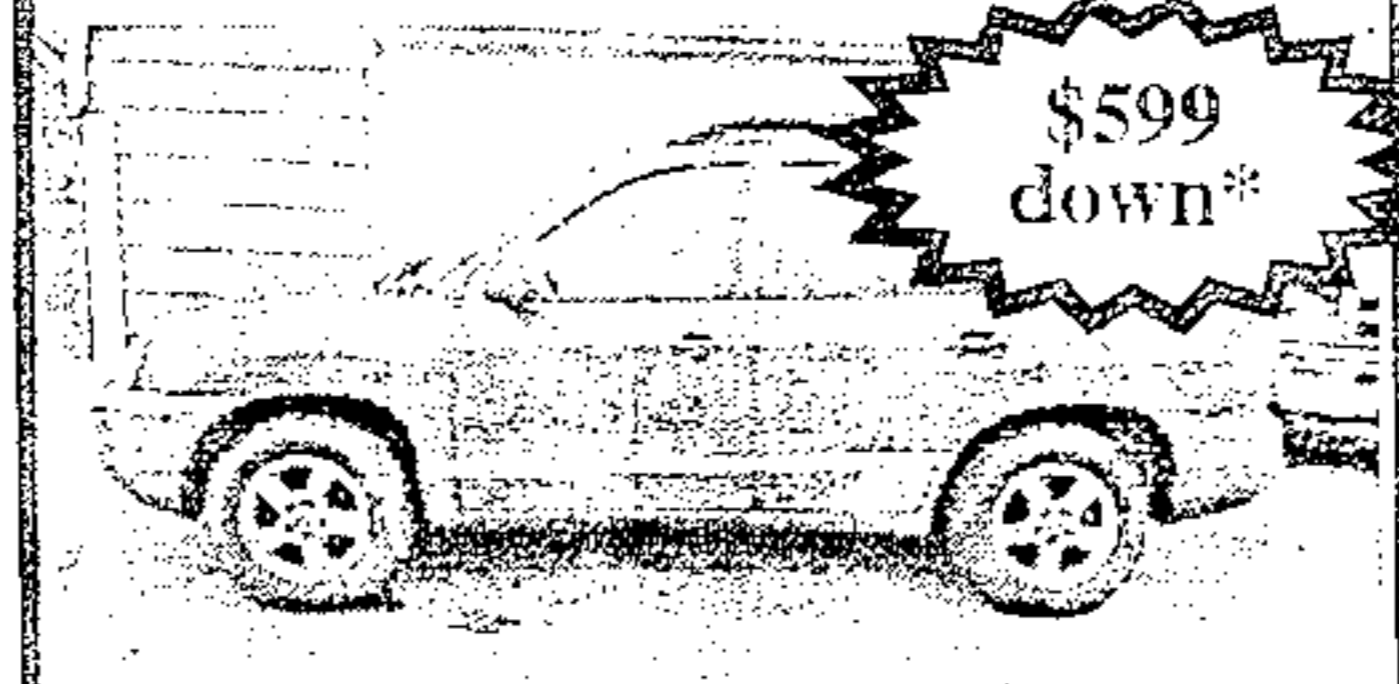

04 Santa Fe, auto, Nice, clean, Only \$599 down\*

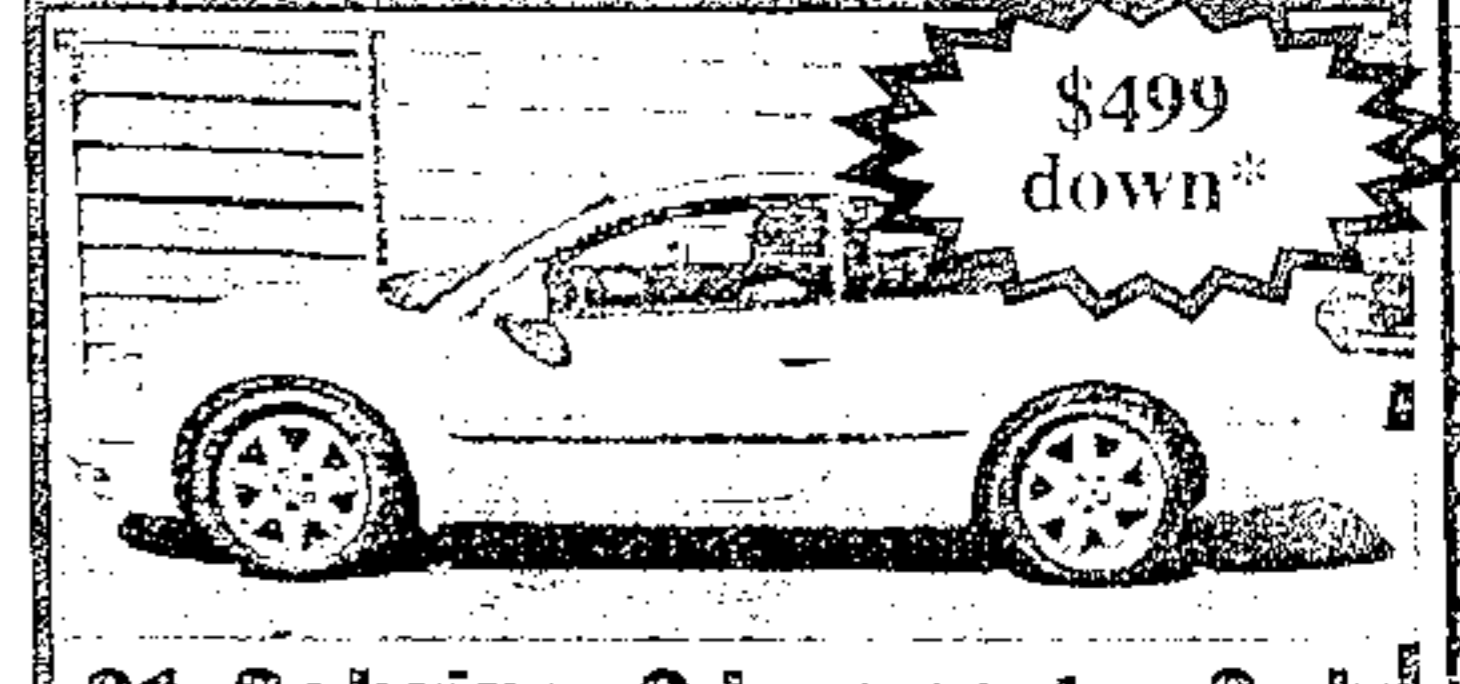

01 Sebring 2dr. sporty, Only \$499 down\*

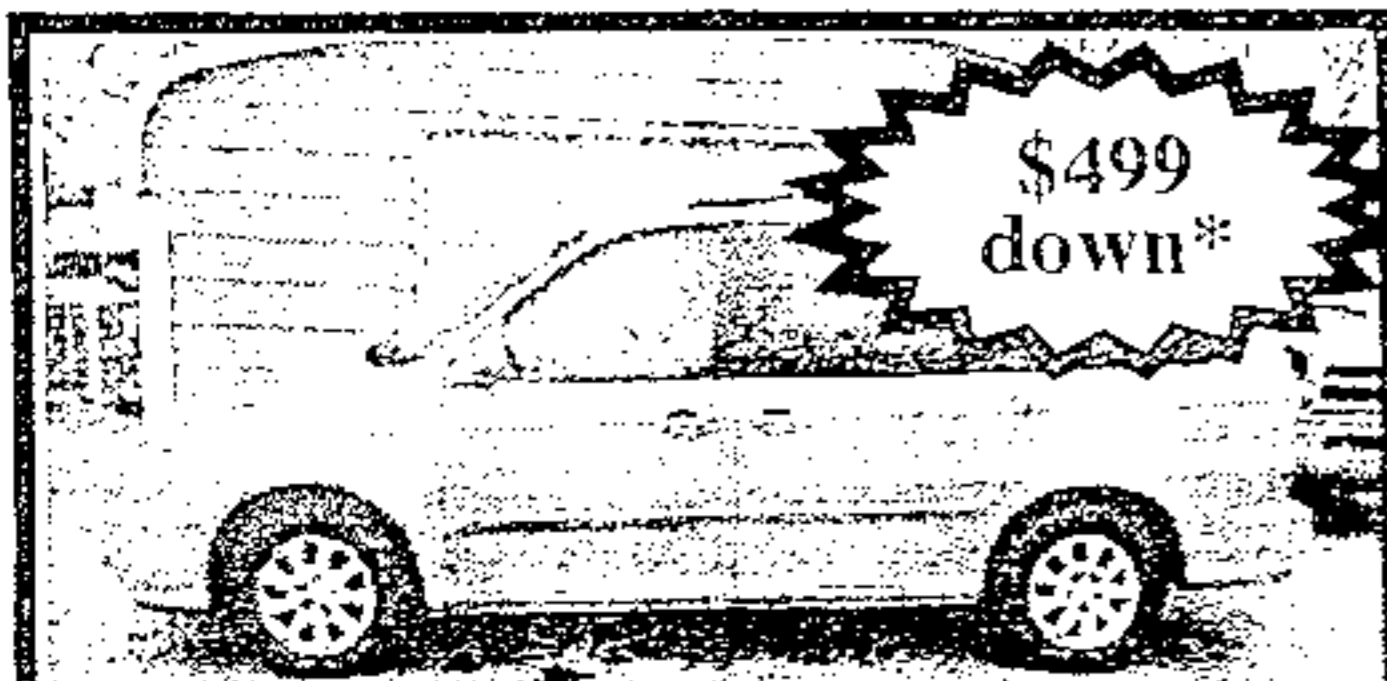

05 Sedona, Runs Great, Only \$499 down\*

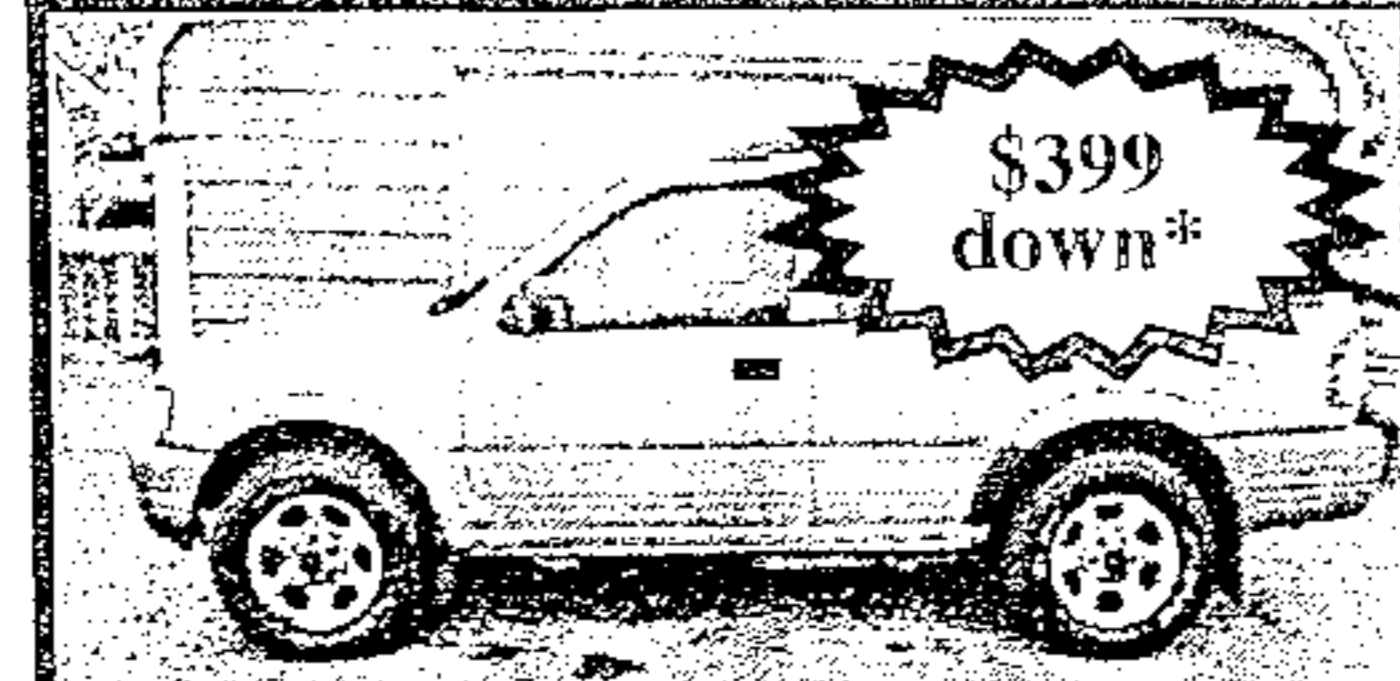

01 Rodeo, 4cyl, 5spd, Gas Saver Only \$399 down\*

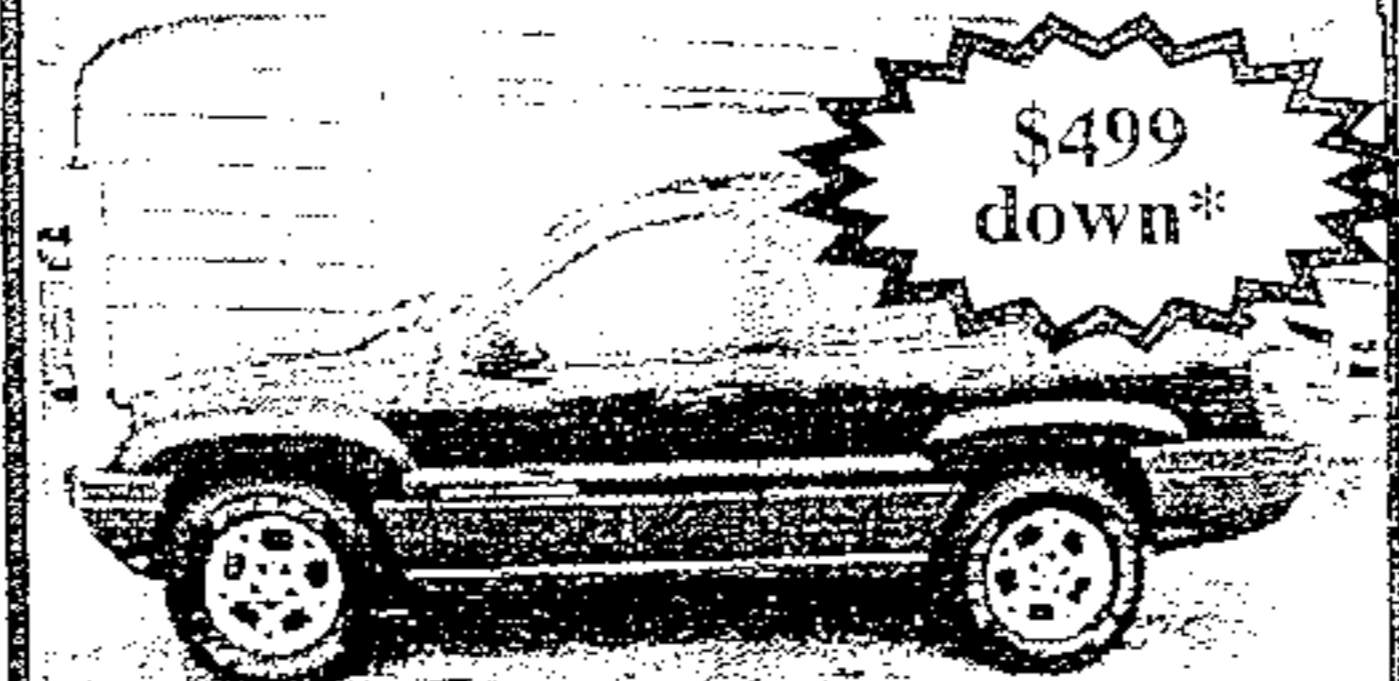

99 Grand Cherokee, Loaded, lthr, Only \$499 down\*

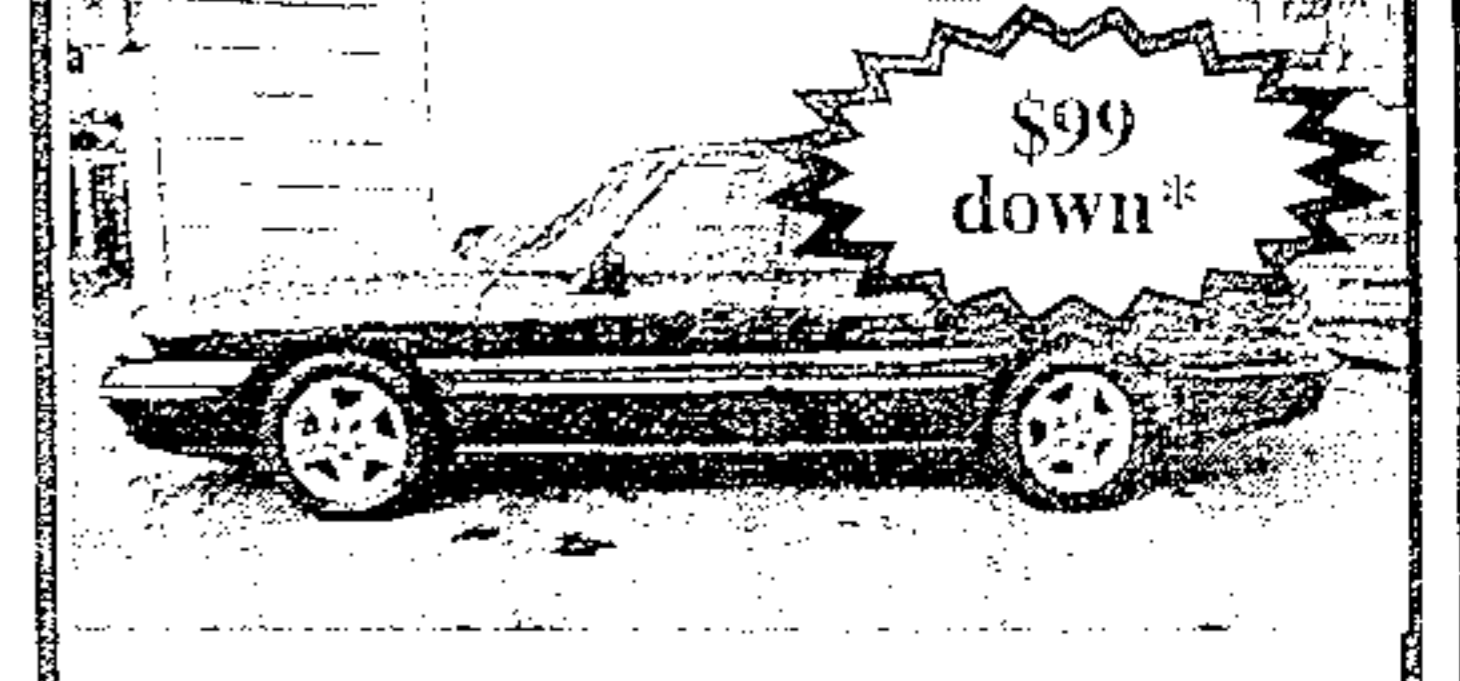

98 Bonneville, 6 cyl, Auto, low payments only \$99 down\*

NO  
Credit Checks

Marty's Auto Sales  
986-2222

Se Habla  
Español

100%  
Approval

\*See Dealer for details. All down payments plus tax, tag, title and fees.

MARTY'S AUTO SALES • 986-2222 • MARTY'S AUTO SALES • 986-2222 • MARTY'S AUTO SALES • 986-2222 • MARTY'S AUTO SALES • 986-2222 • MARTY'S AUTO SALES •

brothers conc. from pg. 7  
 tise of its member fed-  
 eral agencies in coop-  
 eration with state and  
 local law enforcement.  
 The principal mis-  
 sion of the OCDETF  
 program is to identify,  
 disrupt, and dismantle  
 the most serious drug  
 trafficking and money

laundering organiza-  
 tions and those primar-  
 ily responsible for the  
 nation's drug supply.

To Advertise  
 for as low as  
 \$1 per day  
 Call  
 865-771-2249

## THE RELIC SHOP

521 Hwy 321 Lenoir City Suite 3  
 next to Stained Inc and the Inn of Lenoir

**NOW OPEN**  
**865-250-9280**

WHERE A PERSON CAN BUY A PIECE OF HISTORY  
 INDIAN ARTIFACTS, CIVIL WAR RELICS, FOSSILS  
 ANTIQUE GUNS, ANTIQUE POCKETWATCHES,  
 OLD COINS AND WHOLE LOT MORE!!!

### Is Your Washer Broken?

Call Me  
 I Only Charge \$100 Period!!!  
 Call Allen  
 865-617-7113

A Name You Already Know And Trust Just Got Even More Dependable  
**DEPENDABLE AUTO SERVICE, LUBE AND TIRES**  
**is Now Offering**  
**Expert, Affordable Transmission Service**

All ASE Certified Technicians

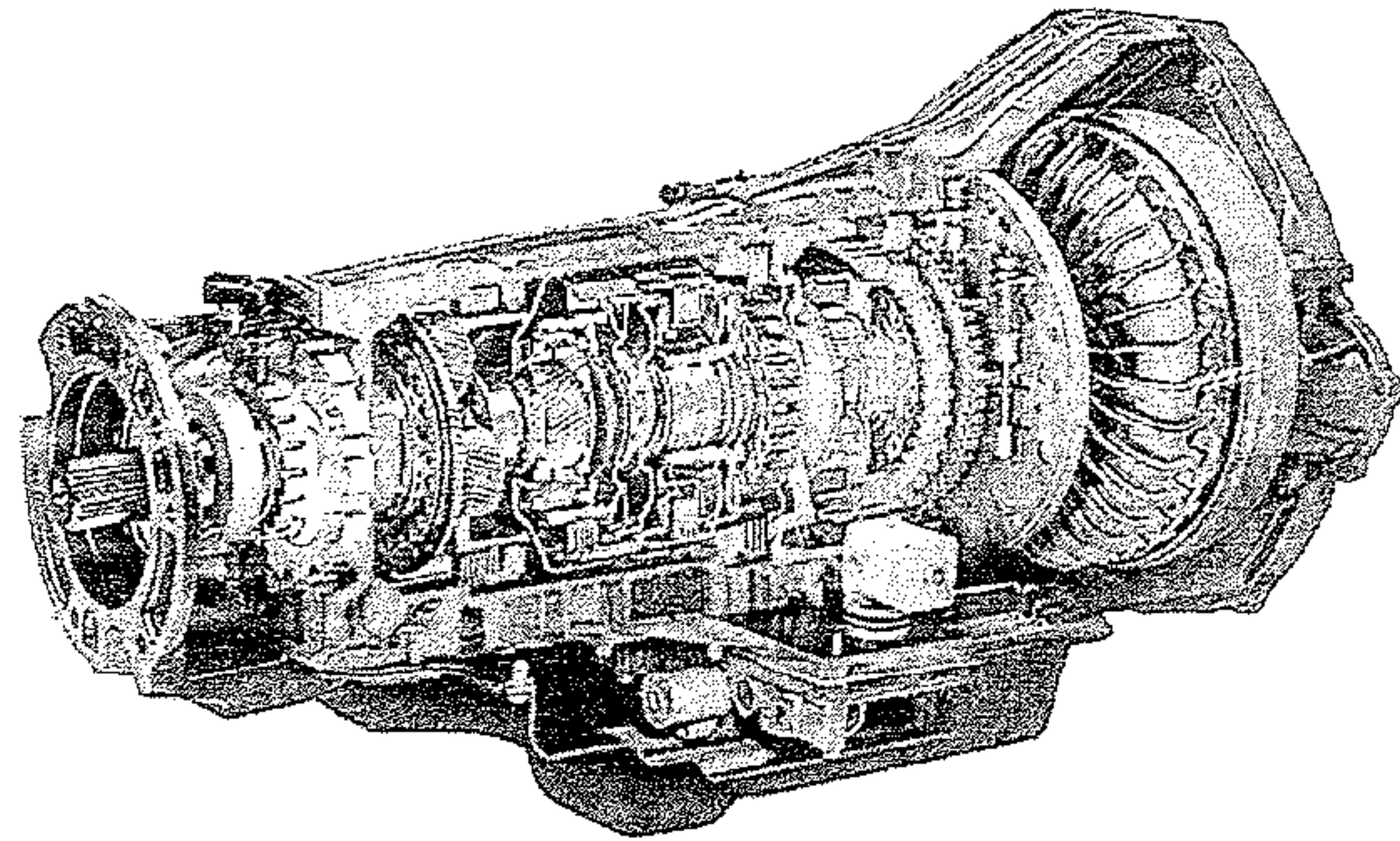

We proudly welcome all New Customers  
 and Former Advanced Transmission  
 Customers with a 10% Discount and Any  
 Transmission Service or Repair\*

**865-986-9359**

**865-986-5050**

## Bad Credit, No Credit OK!!! We Finance Everybody!!!

Taxes Done Here!!! Bring your last pay stub or W2 and DRIVE TODAY!!!

Over 100 Cars, Trucks & Vans in Stock - Warranties On ALL Vehicles Sold!!!

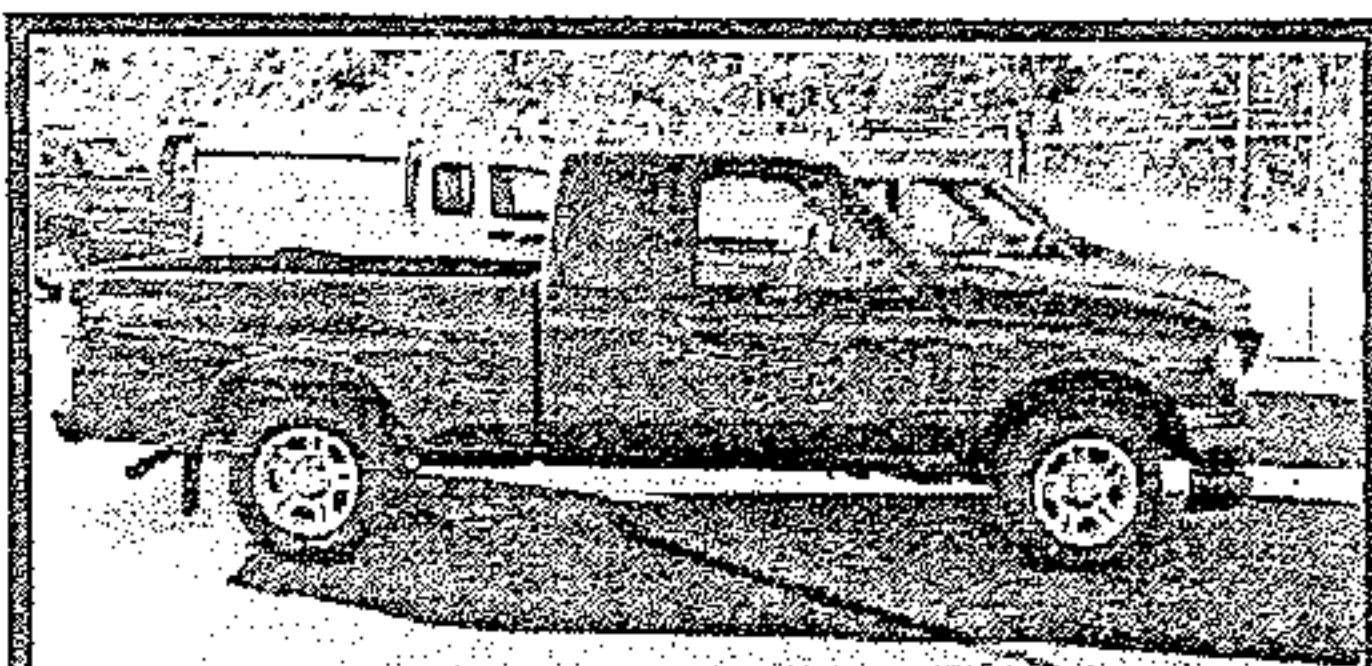

2005 Ford Ranger, Super  
 Nice Truck, Very Low Miles



2015 Nissan Versa Note, Fac-  
 tory Warranty, Low Miles

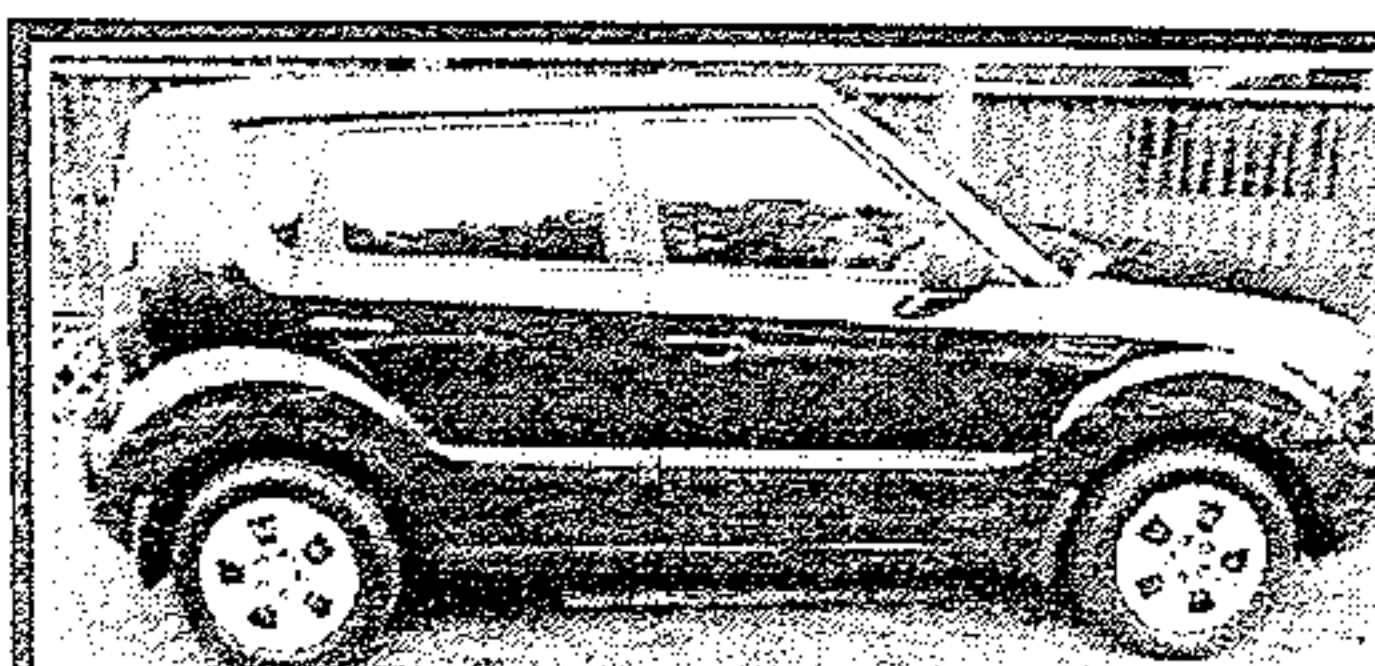

2011 Kia Soul, 5 speed, 4 dr,  
 Gas Saver, Nice & Clean



2007 Chevy Equinox, 4dr, Extra  
 Clean, lots of room

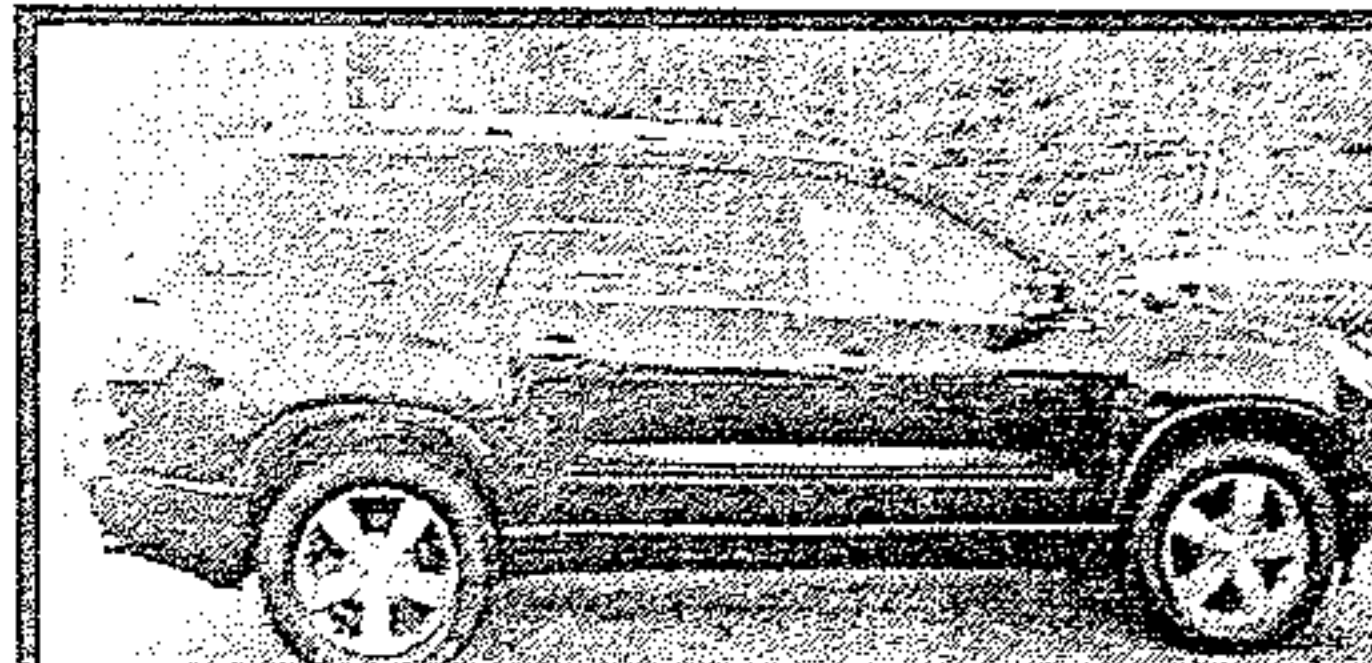

2010 GMC Acadia, Leather,  
 3rd row, sunroof, Loaded

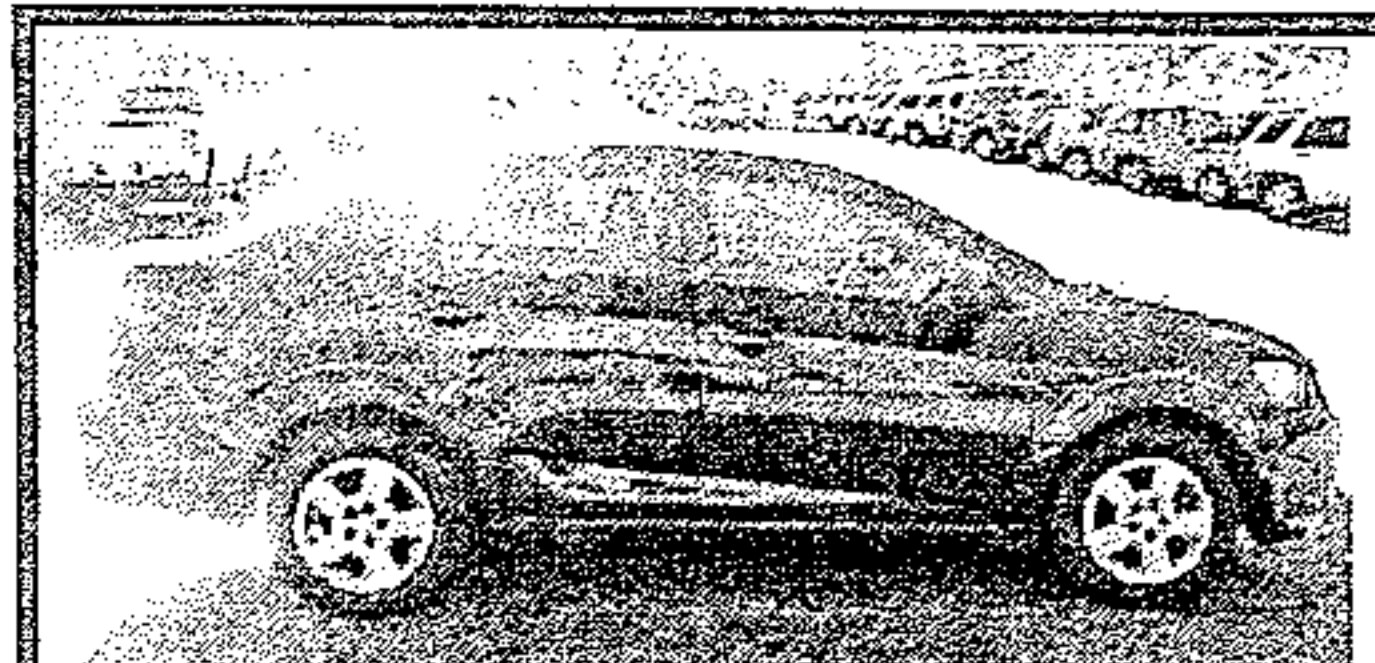

2014 Chevy Sonic, Factory  
 Warranty, Low Miles!

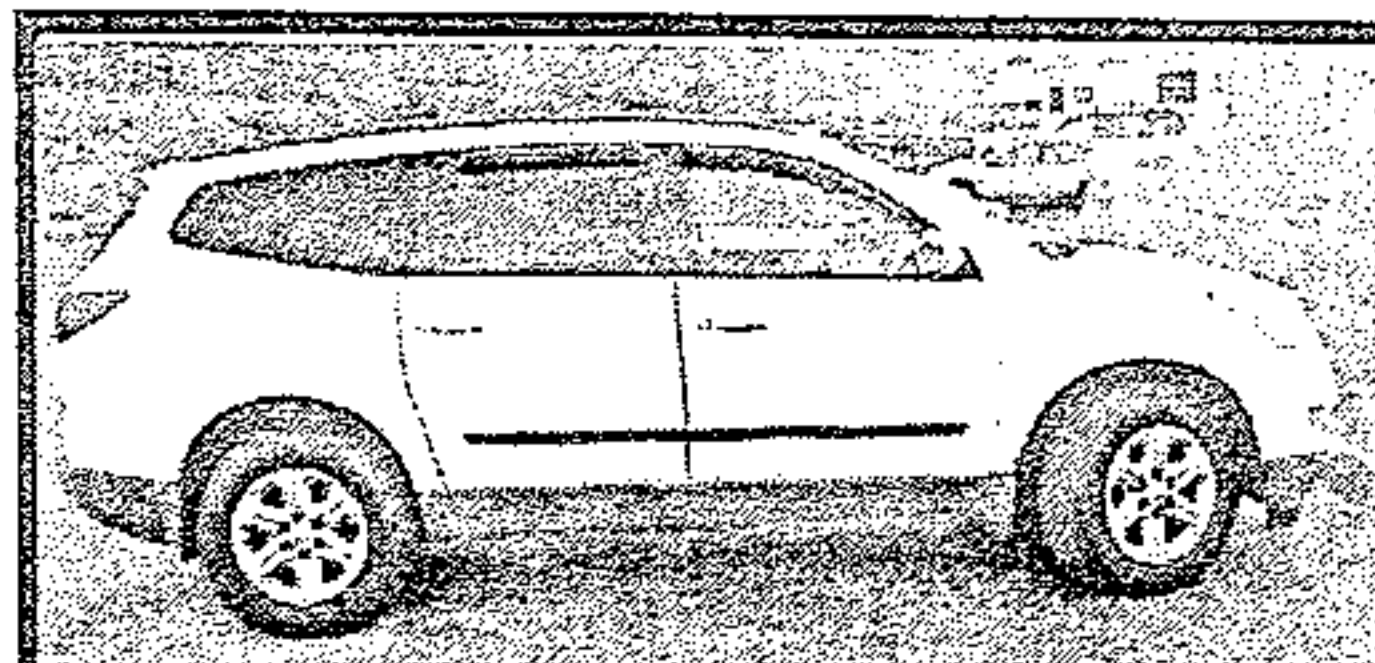

2010 Chevy Traverse, 3rd row  
 seat, Loaded, Clean

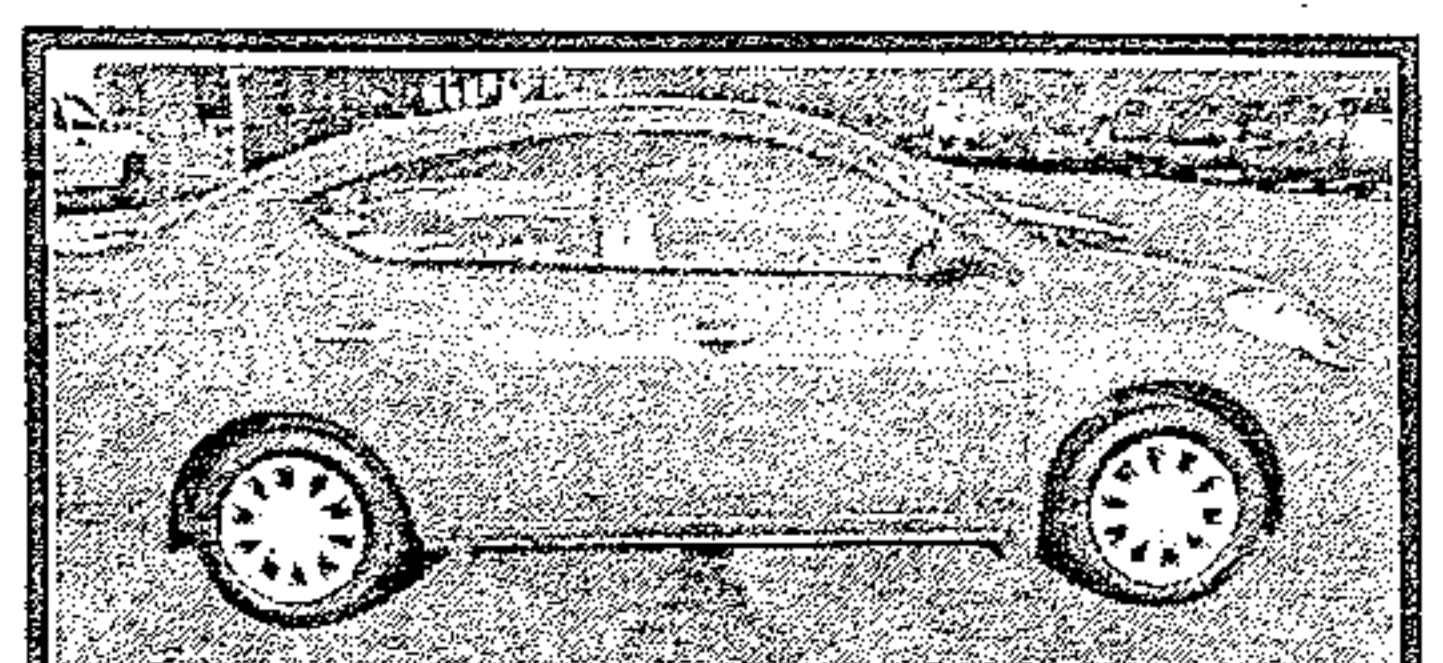

2013 Nissan Versa, Like New!  
 LOADED!!!

# WALT WILLIAMS, INC.

3003 Highway 11 <sup>\*with approved credit</sup> Lenoir City, TN **865-986-1111**