

The Daily Edition

50¢

Serving Loudon, Monroe and Surrounding Counties

Monday, February 29, 2016

Ex-Marine Involved in Murder for Hire in Roane County

Joint Release of the Roane County Sheriff's Office and the 9th District Attorney General's Office concerning an arrest in a Roane County Murder-for-Hire Scheme

Roane County Detective Bryan Walker arrested Laura Ann Buckingham (W/F dob 4/21/1986) of 507 West Race Street in Kingston Wednesday (see murder pg. 2)



Laura Ann Buckingham

Over 90mph in chase on I-75 Meth found on revoked driver



Amanda Ward

(see revoked pg. 5)

All Methed Up and nowhere to go!

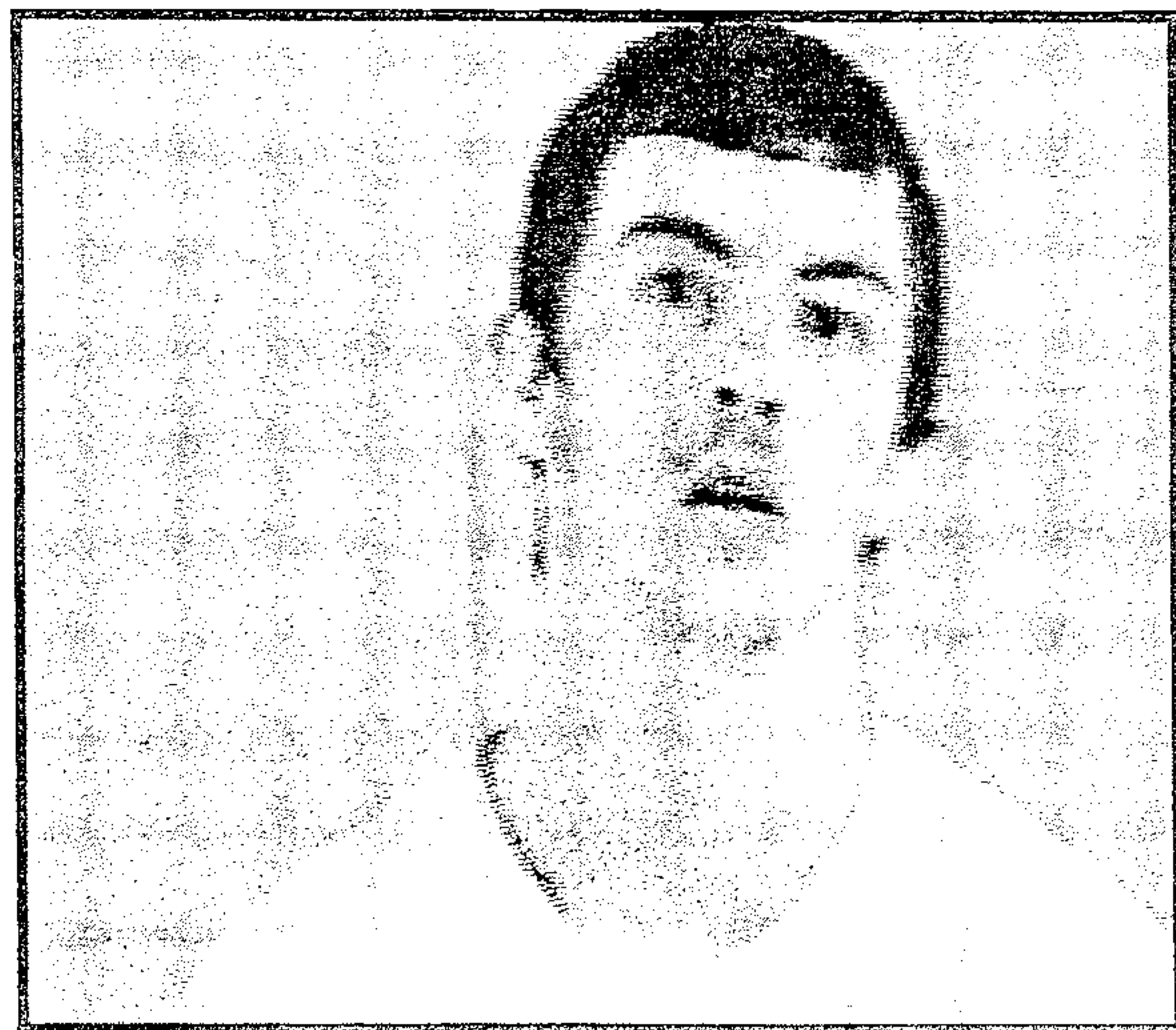

(see meth pg. 7) Justin Bellamy

Marine sniper foils alleged murder-for-hire plot
A Marine veteran known for an embarrassing wartime controversy is being credited with helping police in Tennessee stop his fiancée's alleged plan to hire a hit man to kill her ex-boyfriend.
Joseph Chamblin, a former scout



Joseph Chamblin (see plot pg. 4)

Passed out in the parking lot



James Pasini

(see DUI pg. 3)

Verse of the Day

Jesus would not entrust himself to them, for he knew all men. He did not need man's testimony about man, for he knew what was in a man.
— John 2:24-25

Obituaries

see inside

Wazzup

It's Leap Year Today is the 29th day of February that only occurs every four years!

Weather

Today: Cloudy skies early, then partly cloudy in the afternoon. Slight chance of a

rain shower. High near 65F. Tonight: Partly cloudy. Low 47F.

Tuesday Scattered thunderstorms in the morning, then mainly cloudy during the afternoon with thunderstorms likely. High 67F.

Tuesday Night Thunderstorms likely in the evening.

Then the chance of scattered thunderstorms later on. Low 47F.

Horoscopes

Pisces 2/19-3/20

Someone may ask for your emotional support today but all you can bring is a wider perspective and
(Continued on page 6)



1 08805 93489 2

murder

evening on a warrant for Criminal Attempt to Commit First Degree Murder. As the warrant alleges 'Buckingham did attempt to commit the offense of first degree murder.... she acted with intent to complete a course of action that would constitute the offense of premeditated murder by hiring and paying another to

kill Bradley Sutherland and thereby taking a substantial step toward the commission of that offense'.

Bradley Sutherland lives in Indiana and is evidently Buckingham's former boyfriend and the father of her three year old son. Sutherland and Buckingham were sharing custody of the child. Laura Ann Buckingham, since her recent move to Ten-

nessee, has been driving to the Louisville, Kentucky area every Sunday to effectuate the exchange of the son with his father.

At District Attorney General Russell Johnson's request the City of Louisville Police

Department Homicide Division's Lt. Todd Kissinger had local detectives contact Bradley Sutherland at his place of employment in Louisville to notify him of the murder-for-hire plot. Sutherland is

(see murder ctd. pg. 4)

Notice: The Daily Edition does not knowingly accept fraudulent or misleading materials. The Daily Edition cannot guarantee the validity of offerings or statements contained herein. All liability for the contents of all advertising, and for any claims that may arise therefrom, is the responsibility of the advertiser or its agency. The Daily Edition reserves the right to reject, edit, or abbreviate any advertisement submitted. Advertising is accepted with the understanding that all liability for all copyright violations is the sole responsibility of the advertiser. Photographs, artwork and other copy submitted for publication is considered the sole property of the advertiser. The Daily Edition will make every effort but will not be liable for failure to publish and ad or for typographical and layout errors. All statements and information about highlights featured items, letters to the editor, herein are those solely given to the interviewer or writer and the Daily Edition assumes no responsibility of the accuracy or validity thereof. The Daily Edition will gladly reprint at no charge that part of an advertisement in which an error occurs provided a claim is made within 3 days of the first publication of the ad. Information contained in the Wazzup is received anonymously and the Daily Edition assumes no responsibility for information and reserves the right to edit or reject any and/or all submissions. The Daily Edition is a daily newspaper of general circulation in Loudon County defined under TCA 2-1-104(a)(13). The Daily Edition also serves Monroe, Knox, Anderson, Roane and Blount counties and serves 30,000 readers weekly. Send mail to PO Box 1240, Lenoir City TN 37771. 865-771-2249. email: dan1204us@yahoo.com

The Daily Edition is Loudon County's premier public interest and paid advertising paper. The Daily Edition is produced and published daily Monday through Friday and is circulated throughout Loudon County and parts of Monroe and Knox Counties. Display advertising rates \$5.00 per column inch and quantity discounts available. Call for information on upcoming promotions and events.

HACIENDA Ayala's
Mexican Restaurant
 Market Dr. * Lenoir City (In Front of Food City)

Real Authentic Mexican Food at Affordable Prices

BEST MARGARITA

You've Tried The Rest
 Now Come Have The Best!!!

We Accept ALL Competitors Coupons Outside of Mexico City!

986-3553



Good Credit OK • Bad Credit OK • Bankruptcies OK • Repo OK



2010 Kia Soul Sporty, 4 cyl, Auto, PW, PL, A/C, Great On Gas, Like New



2010 Ford Escape Limited Leather, Alloy Wheels, Heat, A/C, Luggage Rack, 79K,



2007 Dodge Ram 1500 Quad Cab, Thunder Road PKG, 20 in. Wheels, Low Miles, Hemi



2008 Ford Explorer 84k, 3rd Row Seating, Luggage Rack, Tow Pkg, PW, PL



2011 Ford Ranger Low Miles, Tow Pkg, New Tires, A/C, Heat, Bed Liner.



2011 Dodge Grand Caravan DVD, Stow & Go, Loaded, Remote Doors, Rear A/C

DEPENDABLE MOTORS 986-9343
 803 E. Broadway • Lenoir City

Serving Loudon County for 20 Years

* WAC. See Dealer for details

Visit our website at: www.dependablemotorslc.com

FBI

James Pasini, 47, Lee Hi Lane Lenoir City, was charged with DUI, and Violation of implied Consent.

Sgt. Jerramie Bowen LCSO, did notice a vehicle in the parking lot of the TA

Travel center at Watt Rd. the driver was slumped over the steering wheel Deputy then knocked on the window to check on the subject. The driver later identified as James Pasini was passed out and when Deputy knocked on the window the subject knocked back on threw window.

Deputy asked him to roll the window down or open the door and Mr. Pasini could not do either one for approx. one minute. Mr. Pasini finally got the door open. Deputy could smell a strong odor of alcohol coming from the vehicle. Deputy then asked the driver to exit the driver seat he did turn the vehicle off and refused to step out of the vehicle. Deputy asked if he would perform field sobriety and he refused. Deputy then told him to exit the vehicle and advised

him he was under arrest and he then stepped out and Deputy told him to face his vehicle to pat him down. As Deputy was patting him down he began to clinch his fist and Deputy advised him that was not a good idea. When Deputy went to put the cuffs on Mr. Pasini he clinched his fist up a again and Deputy then placed the first cuff on and he began to become combative and Deputy Reagan arrived and helped

cuff him and place him in the patrol unit. Mr. Pasini did become more combative and began to hit his head and kick the cage. Deputy then transported him to the Loudon County Jail.

When we arrived at the jail Deputy read him a copy of the TN implied consent and he did refuse. This did occur in Loudon County. Cpl. Jerramie Bowen LCSO, made the arrest.

For Sale: oak Wood Mulch



Mushroom Compost Topsoil.

Firewood



Call Steve Spoon 986-4282

West End Storage & Warehouses
502 Ward Avenue • Loudon
Call 865-458-4774 or 865-679-5555

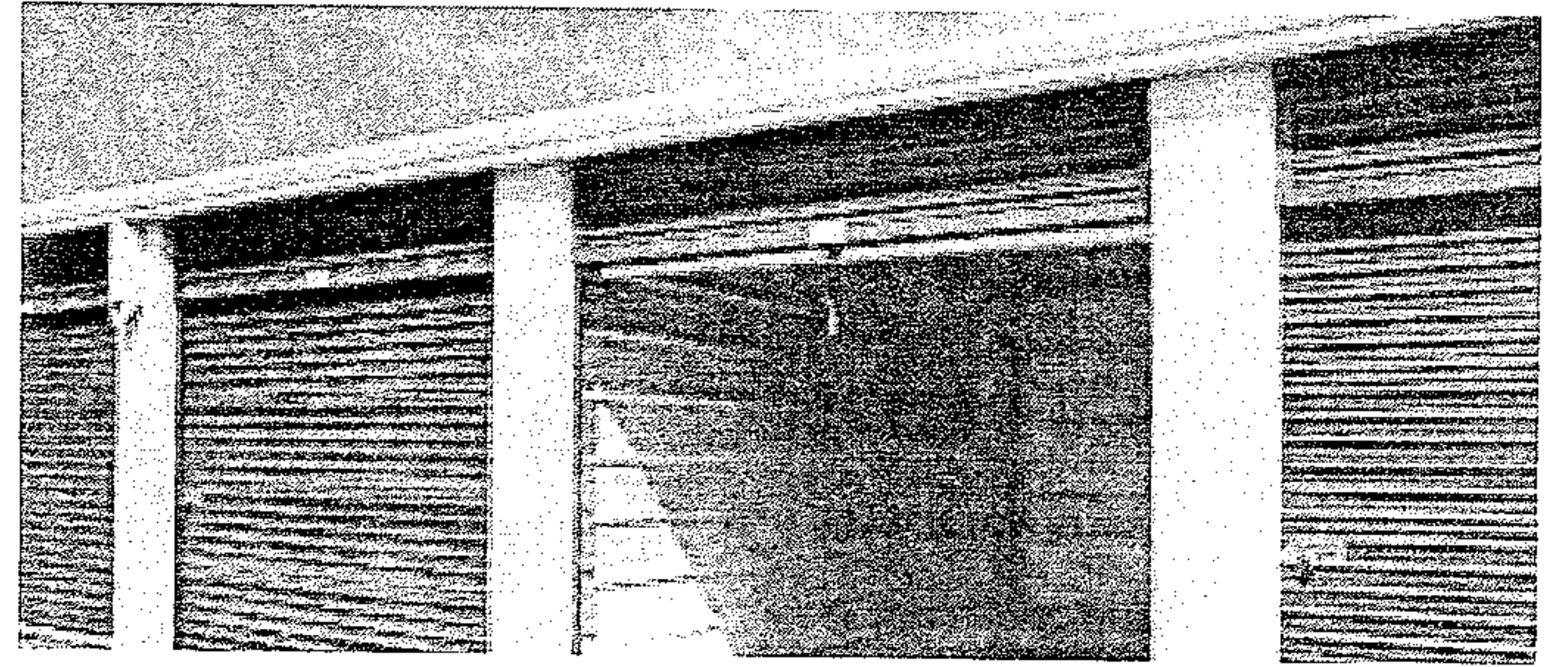

STAINED INK

TATTOO & PIERCING

LENOIR CITY 865 816-6440

NEW OWNER • NEW ARTIST • SINCE 2011

521 Hwy 321 next to Vape & Stuff & Inn Of Lenoir!

**Clean-Affordable-Quality-Custom
 Tattoo's You've Always Wanted!**

**BRING IN THIS Ad FOR \$25 OFF
 NEW INK FOR NEW CUSTOMERS ONLY!**

Check us out on FB.com/
 Stained.Inc.Tattoo/
www.STAINEDINC.com

C&J Towing and Recovery

LOWEST TOWING RATES AROUND!!!

Have you been overcharged for any type of towing service in the Lenoir City area? If you have a breakdown or accident please OWNER REQUEST C&J Towing with the officer. Also please call your Sheriff and ask him to place C&J Towing on the "Rotation List*" and help other motorists save as much as you did! We at C&J are locally owned and operated, State approved, licensed, bonded and insured. Call and let us know if your denied service or how we can be of assistance.

*note: the "Rotation List" is a list of wrecker services that provide service for wrecks, DUI's, breakdowns, etc. and are on an on-call basis for service. This list is approved by the Sheriff.

Cliff Teeters • Owner
 865-809-1661

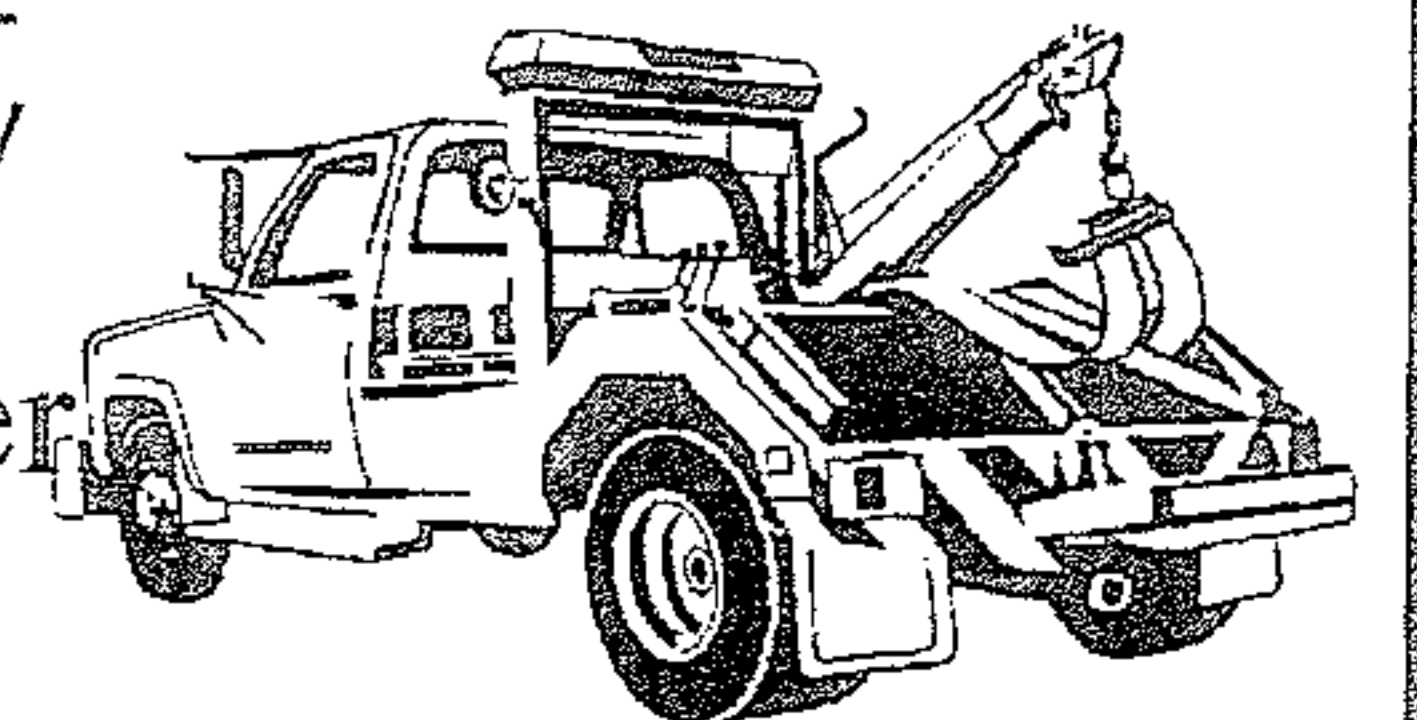

BIMBO'S

Deli Open 24 Hours

865-986-9643 Call Ins Welcome

Specials

**Lg. Cold Sub, bag of chips and 16 oz. fountain drink
 only \$6.29**

Footlong Corn Dog \$2.59

plot sniper whose military career came to an end after a video surfaced showing him and other Marines urinating on enemy corpses, tipped off law enforcement in Kingston, Tennessee, that his fiancée, Laura Ann Buckingham,

had allegedly repeatedly asked for his help in making her ex "go away," according to the Knoxville News Sentinel.

murder ctd. from pg. 2 now cooperating with Roane County Sheriff Jack Stockton's detective division in their

ongoing investigation of Buckingham's scheme.

No other arrests have been made and none are expected. Buckingham's bond was set by Roane County General Sessions Court Judge Terry Stevens at \$150,000.

Buckingham's son is back in Indiana with his father.

Vegas and nearby Henderson, Nevada. Today she's in a federal prison after being sentenced last month by a U.S. district judge.

It all started on a winter afternoon in 2012. While Williams sat in her car outside an outlet mall clothing store in Las Vegas, her accomplice, Anthony Jordan, was inside checking out merchandise. Jordan already had a sweater and a bottle of cologne in his possession when he asked an employee to bring out two watches from a locked glass container.

With the items in hand, Jordan made his way to the registers to check out. As the cashier began

ringing him up, Jordan brandished a semi-automatic handgun and demanded everything from the drawer.

In all, Jordan walked out of the store with hundreds of dollars worth of stolen merchandise and cash. He found Williams waiting in the car nearby, and the two fled the scene.

Following the successful outlet store heist, Williams and Jordan continued to carry out a flurry of robberies between December 2012 and March 2013. In a span of just a few short months, Williams, Jordan, and a third accomplice led an intense crime spree, lifting

(see FBI ctd. pg. 5)

Public Notice
 The Loudon County Corrections Partnership Committee will meet March 2nd, 2016 at 12:00 at the Justice Center to discuss future plans.

APPLY FOR AN EASY ADVANCE AND GET MONEY FAST!

\$750 Easy Advance at Liberty Tax at No Additional Cost!

820 Hwy 321N Across from Burger King
 119 E. Broadway Street Downtown Hwy 11

Lenoir City, TN 37771
865-986-8335

An Easy Advance (EA) is a \$750 loan secured by your tax refund and is offered by Republic Bank & Trust Company, member FDIC, to qualifying applicants. There are no fees or interest associated with the EA. Subject to approval. Visit your Liberty office to learn more. Offer Expires 2-28-15.

BUDGET Transmissions

302 S. Northshore Drive Knoxville
 (865) 584-4391 budget-transmissions.com

Why Buy From Budget?
 Free Towing From Lenoir City or Loudon County
 20 Years of BBB Zero Customer Complaints Award Member
 A+ Plus Rated
 Huge Transmission Inventory
 Best Technicians Period!!!
 Call (865) 584-4391 Today!





good to know you™

IMMEDIATE OPENINGS!

Randstad is NOW HIRING for 2nd shift Assembly Positions at Commercial Vehicle Group. These are long-term, temp-to-hire positions!

Hours: 4:30pm - 3:30am (end times vary)
 Pay: \$10/\$10.50 per hour

You may apply by visiting our Facebook page www.facebook.com/vonorejob and clicking the "Sign Up" button. You can also get a paper application from the Guard Shack at 200 National Drive, Vonore, TN 37885.

For questions, call 423.884.4733
www.randstadstaffing.com

EOE



Staffing | Professionals | Search & Placement | HR Solutions | Inhouse Services

aggravated

Amanda Ward, 24, W Broadway Lenoir City, was charged with Simple Possession SCH. II, Evading Arrest, and Driving on Revoked/Suspended License. Trooper James Dalton THP, was running stationary radar at the 66 mm in Monroe Co on I75. Trooper clocked a Chevy at 94 in a 70 mph zone. Trooper turned on his emer-

gency lights just before the vehicle passed him. Trooper pulled out in attempt to catch up with the vehicle entering Loudon County. The vehicle did not attempt to slow down or stop. As traffic got slower the vehicle was changing lanes without signaling. The vehicle pulled onto the shoulder and started passing traffic. The vehicle eventually stopped at the 68 mm.

The driver identified as Amanda Ward was arrested for fleeing. A check of Amanda's license revealed they were revoked for DUI. A alert from Deputy Jenkins K-9, a ball of aluminum foil was discovered in the center console. Inside the foil was clear bag and a folded piece of paper both containing a white crystal powder, field tested to be methamphetamine. Trooper

James Dalton THP, made the arrest.

FBI ctd. from pg. 4

merchandise and emptying cash registers at businesses and banks in the region.

Anything from clothing stores and fast food chains to banks inside grocery stores were consistently targeted by Williams and her group. Although she never stepped inside the businesses that

were robbed, Williams supplied disguises and a handgun while fulfilling the role as getaway driver for every crime.

The unprecedented number of robberies committed by the group left frightened store employees and empty cash registers in their wake. But the spree ended after a tip made to the FBI's Las Vegas office spurred the Bureau's Las Vegas Criminal Apprehension Team and Safe Streets Gang Task Force to action. The task force combines FBI special agents with detectives from the Las Vegas Metro Police Department and Henderson Police Department to pool expertise in targeting violent criminals, fugitives, and gangs in the region. Williams and crew were now in their crosshairs.

Agents from the FBI's Las Vegas Field Office reviewed hours of surveillance video, conducted interviews, and used other investigative techniques that ultimately led to the arrest of Williams and Jordan in June 2013.

Following the joint investigation, a weeklong trial, and 18 convictions on 18 counts, Williams was sentenced to 121 years in a federal prison for supplying a handgun and assisting as getaway driver during the rash of robberies. Jordan was dealt a similar fate after his trial and is now serving 60 years for his involvement in the crimes.

"Merely displaying a weapon during a robbery carries significant prison time—that's exactly what Williams and her crew did during these robberies," said the FBI Las Vegas agent who led the investigation. "A fed-

(see FBI conc. pg. 8)

PURDY'S AUTO PARTS AND SALVAGE

WE BUY SCRAP IRON • COPPER • BRASS • ALUMINUM

\$

Paying Top \$\$\$

Call For Latest Prices

You Name It, We Buy It!

Radiators, Wheels, Batteries, Appliances, Farm Equipment

Complete Cars

per 100 lbs.

Copper

Paying Top \$\$\$

Call For Latest Prices

Scrap Metal

Paying Top \$\$\$

Call For Latest Prices

per 100 lb

We Buy Batteries

Aluminum Cans

Paying Top \$\$\$

Call For Latest Prices

Now Selling Aftermarket Body Parts at Discount Prices

You Call We Haul!

423-519-5402

* Prices subject to change with the market.

423 337-3977

149 County Road 323 Sweetwater



* Prices subject to change with the market.

meth

Justin Bellamy, 22, County Road Sweetwater, was charged with Man/Sell/Del/Resale SCH. II, Public Intoxication, and Contraband in Penal Institution. Cpl. Chris Hutchens LCSO, was dispatched to the Grizzly Pig for a subject who was reportedly acting out, like there was something wrong with him.

Deputy arrived on scene and did find the subject described in the parking lot of the Grizzly Pig (One Stop Market). The subject was identified as Justin Bellamy. Justin explained to Deputy

Hutchens he was driving his girlfriend and she started talking about taking him to Mexicans, Justin pulled over and exited the vehicle.

According to the report, the girlfriend left Justin at the store. Justin went into the store and asked to use the phone then went in the parking lot looking into vehicles. One man told him to stay away from his vehicle.

At that point Justin backed up and pulled

his knife out and the man then retrieved a shotgun, and Justin fled.

Upon contact with Justin he acting very strange and under the influence of a narcotic. When asked Justin stated he had taken meth earlier. Justin was arrested and transported to the Loudon Jail.

At the jail where Justin was searched Deputy located a small plastic baggie with a crystal like substance inside this was located near Justin private parts. Crystal substance tested positive for Methamphetamine. Cpl. Chris Hutchens LCSO, made the arrest.

Help Wanted
Position Available Immediately! Apply in person at the Kenjo Marathon on Hwy 321 in Lenoir City.

OBITUARIES

Joyce P. Brown - age 64 of Lenoir City, passed away Saturday morning, February 27, 2016 at her home. Joyce was a former employee of Motel 6. She was preceded in death by her son, John Wayne Brown; parents, Fred and Margaret Currier Reynolds; stepfather, John Henry (Snowball) Brown. Joyce is survived by her husband, Ralph Brown; daughter, Martha Brown; grandchildren: Tyler Eugene Hayes, Cody Douglas

Smiley, Amanda Sue Brown, Ashley Hayes, Lexi Victoria Smiley; sisters, Barbara Finchum and Kathy (Don) Hornby; brother, Ronnie (Karen) Brown; daughter-in-law, Lois Ann Brown along with several nieces and nephews. The family will receive friends from 5-7 p.m. Sunday at Click Funeral Home in Lenoir City. Funeral services will be held at 1 p.m. Monday in the Click Funeral Home Chapel with Rev. Dean Bandy and Rev. Tony Bandy officiating. Burial will follow Lakeview Cemetery.

LONNIE JONES OPTICAL DISPENSARY
"We Make The Difference You Can See"
Locally Owned and Operated

Over 1000 Frames To Choose From
No Frame Over \$69.00



On the corner of A & Depot Street, Lenoir City
986-7803
Serving Loudon County for over 40 years

LOOK! \$75 Weekly Payments LOOK!

MARTY'S AUTO SALES • 986-2222 • MARTY'S AUTO SALES • 986-2222 • MARTY'S AUTO SALES • 986-2222 • MARTY'S AUTO SALES • 986-2222 • MARTY'S AUTO SALES • 986-2222 • MARTY'S AUTO SALES • 986-2222

Bad Credit
Divorce
Fixed Income
Repos
Bankruptcy
No Credit

APPROVED! NO CREDIT CHECKS

Visit Us On The Web At:
martysautosales.net

 <p>\$499 down*</p> <p>07 Cobalt, 5spd, gas saver, runs great Only \$499 down *</p>	 <p>\$299 down*</p> <p>99 Solara, V6, auto, sporty, Only \$299 down*</p>	 <p>\$599 down*</p> <p>04 Santa Fe, auto, Nice, clean, Only \$599 down *</p>	 <p>\$499 down*</p> <p>01 Sebring 2dr. sporty, Only \$499 down *</p>
 <p>\$599 down*</p> <p>05 Trailblazer, auto, good miles Only \$599 down *</p>	 <p>\$499 down*</p> <p>04 Aveo, auto, gas saver, Only \$499 down *</p>	 <p>\$799 down*</p> <p>06 Tiburon GT, 5 speed, sporty, Only \$799 down *</p>	 <p>\$99 down*</p> <p>98 Bonneville, 6 cyl, Auto, low payments only \$99 down *</p>

NO Credit Checks **Marty's Auto Sales** **986-2222** **100% Approval** *Se Habla Espanol*

*See Dealer for details. All down payments plus tax, tag, title and fees.

MARTY'S AUTO SALES • 986-2222 • MARTY'S AUTO SALES • 986-2222 • MARTY'S AUTO SALES • 986-2222 • MARTY'S AUTO SALES • 986-2222 • MARTY'S AUTO SALES • 986-2222

FBI conc. from pg. 5

eral offense like this for a single robbery will land you a lengthy prison sentence. The fact that Williams was convicted of five counts of brandishing a firearm during the robberies puts her in jail for a lifetime."

While Williams' get-away-driving days are

over, the FBI continues to apprehend dangerous criminals like her and Jordan by coordinating with local, state, and federal law enforcement agencies and citizens in the community. Solving violent crimes in cities like Las Vegas is also made possible through public leads and tips submitted on tips.fbi.gov.

THE RELIC SHOP

521 Hwy 321 Lenoir City Suite 3
next to Stained Inc and the Inn of Lenoir
865-250-9280

WE ARE IN TUCSON, ARIZONA BUYING UP FOSSILS FOR THE SHOP. WE NEED TO MAKE ROOM!!!
ALL AMETHYST 40% OFF
GREAT SELECTION OF ANCIENT MEGALADON SHARK TOOTH OVER 8 MILLION YEARS OLD

Is Your Washer Broken?

Call Me
I Only Charge \$100 Period!!!
Call Allen
865-617-7113

A Name You Already Know And Trust Just Got Even More Dependable
DEPENDABLE AUTO SERVICE, LUBE AND TIRES
is Now Offering
Expert, Affordable Transmission Service

All ASE Certified Technicians

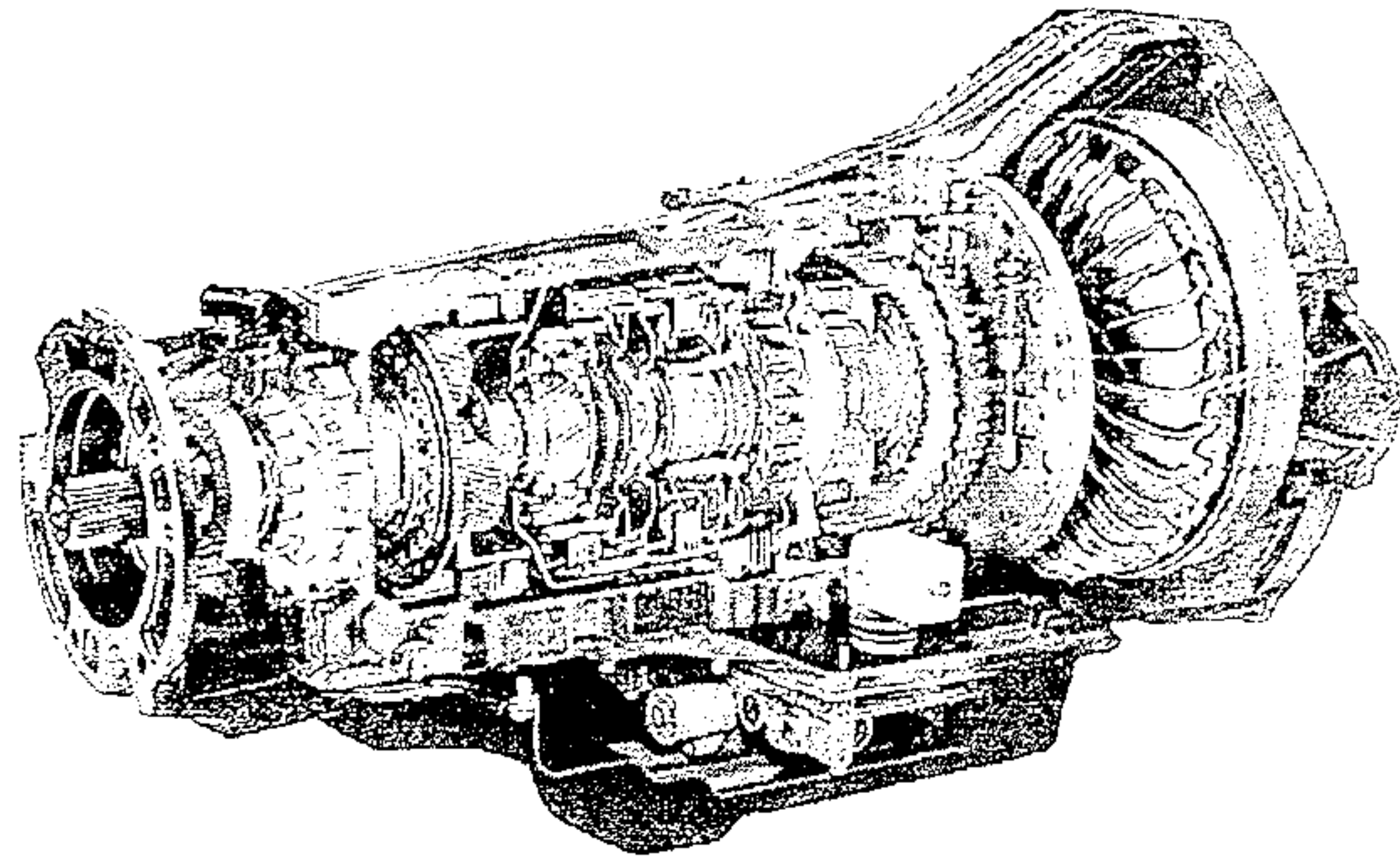

We proudly welcome all New Customers and Former Advanced Transmission Customers with a 10% Discount and Any Transmission Service or Repair*

865-986-9359

865-986-5050

Bad Credit, No Credit OK!!! We Finance Everybody!!!

Taxes Done Here!!! Bring your last pay stub or W2 and DRIVE TODAY!!!

Over 100 Cars, Trucks & Vans in Stock - Warranties On ALL Vehicles Sold!!!

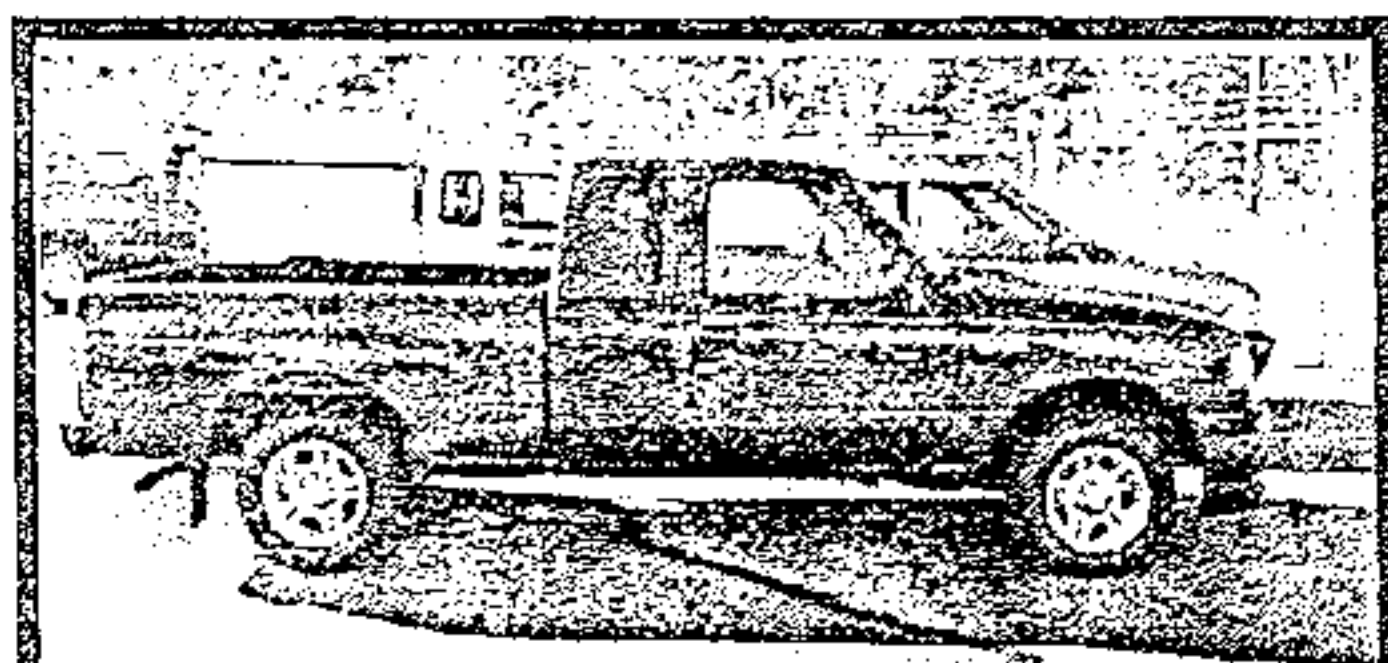

2005 Ford Ranger, Super Nice Truck, Very Low Miles

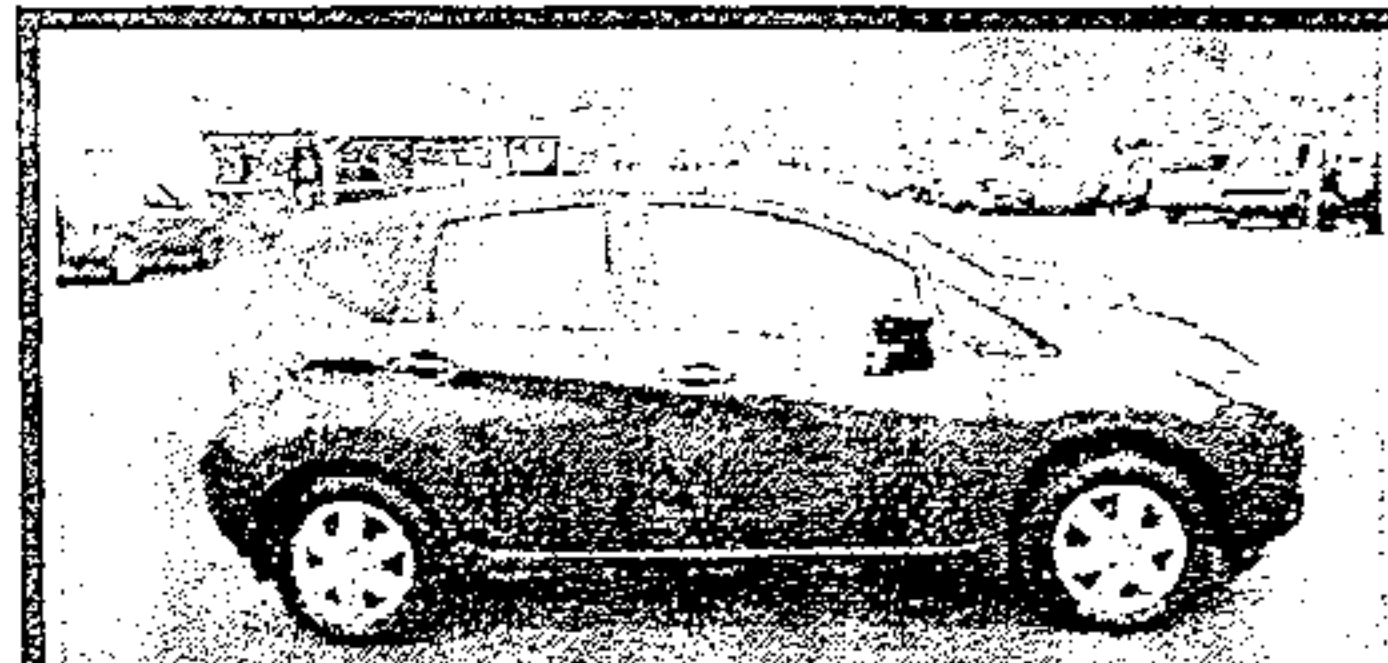

2015 Nissan Versa Note, Factory Warranty, Low Miles

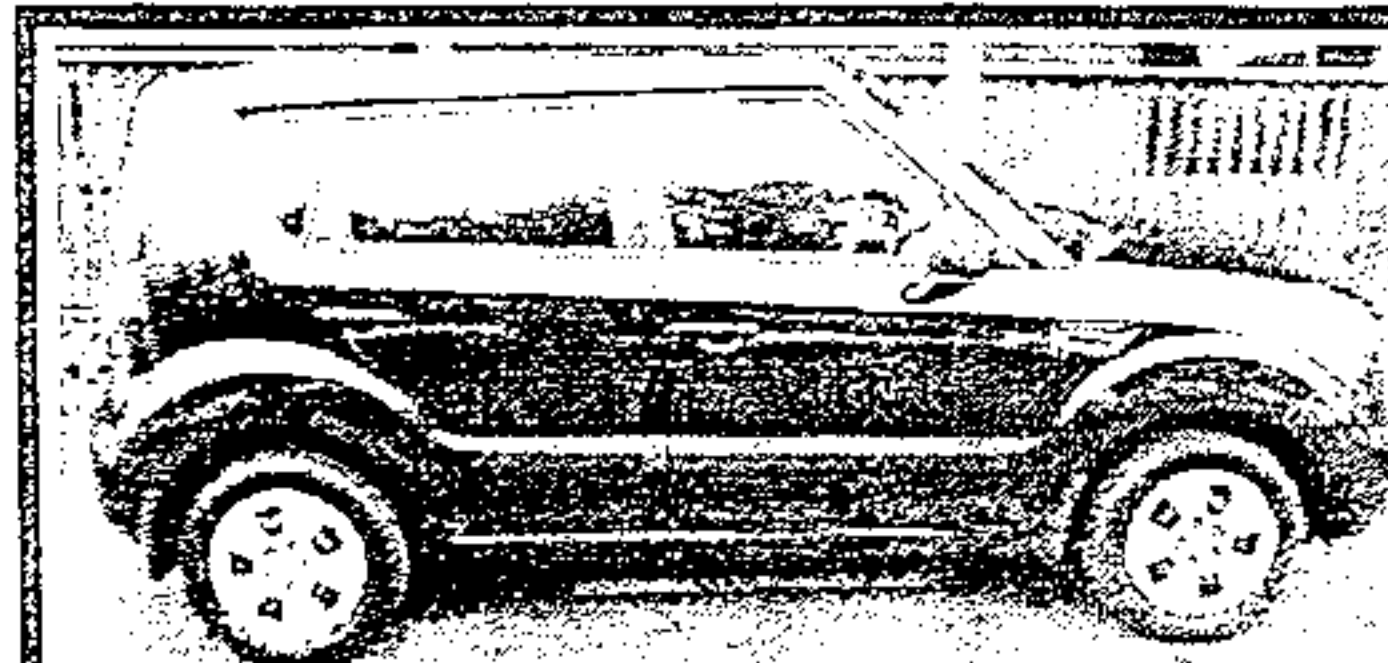

2011 Kia Soul, 5 speed, 4 dr, Gas Saver, Nice & Clean

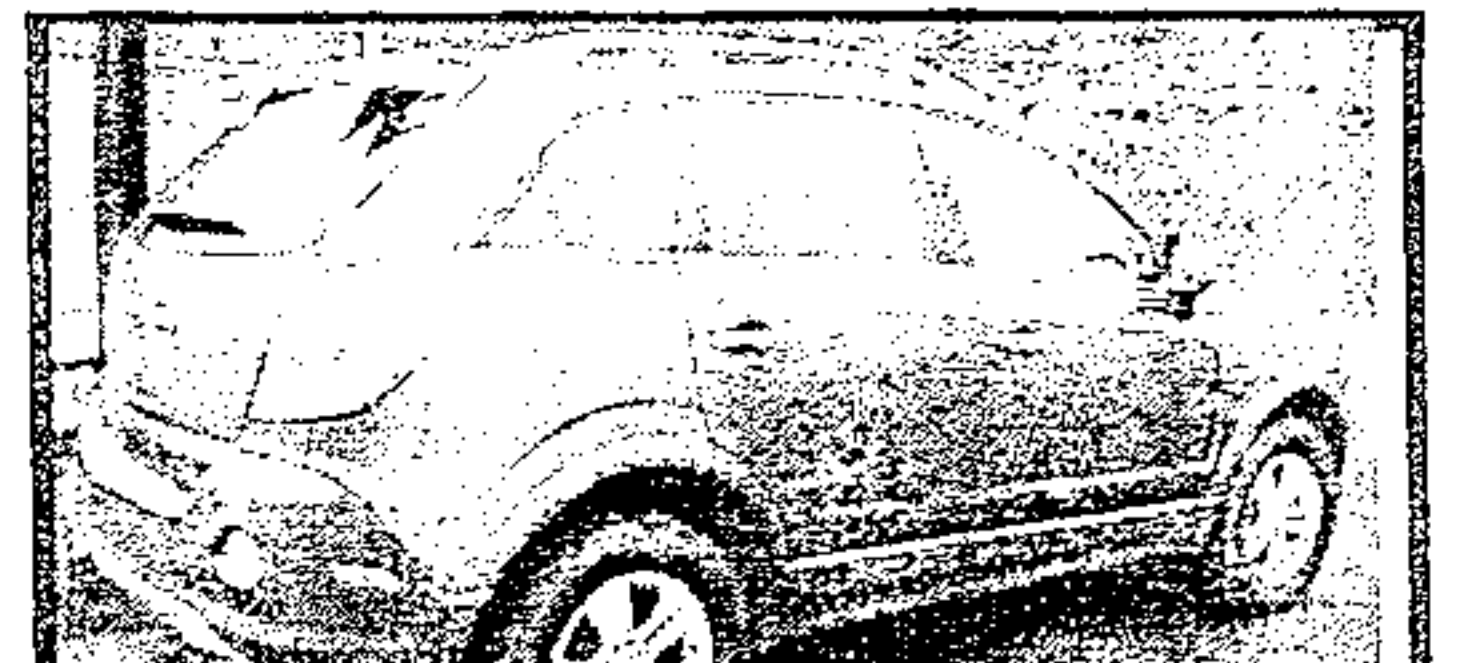

2008 Saturn VUE, LOADED!!! 4dr, Ready to go on a trip!

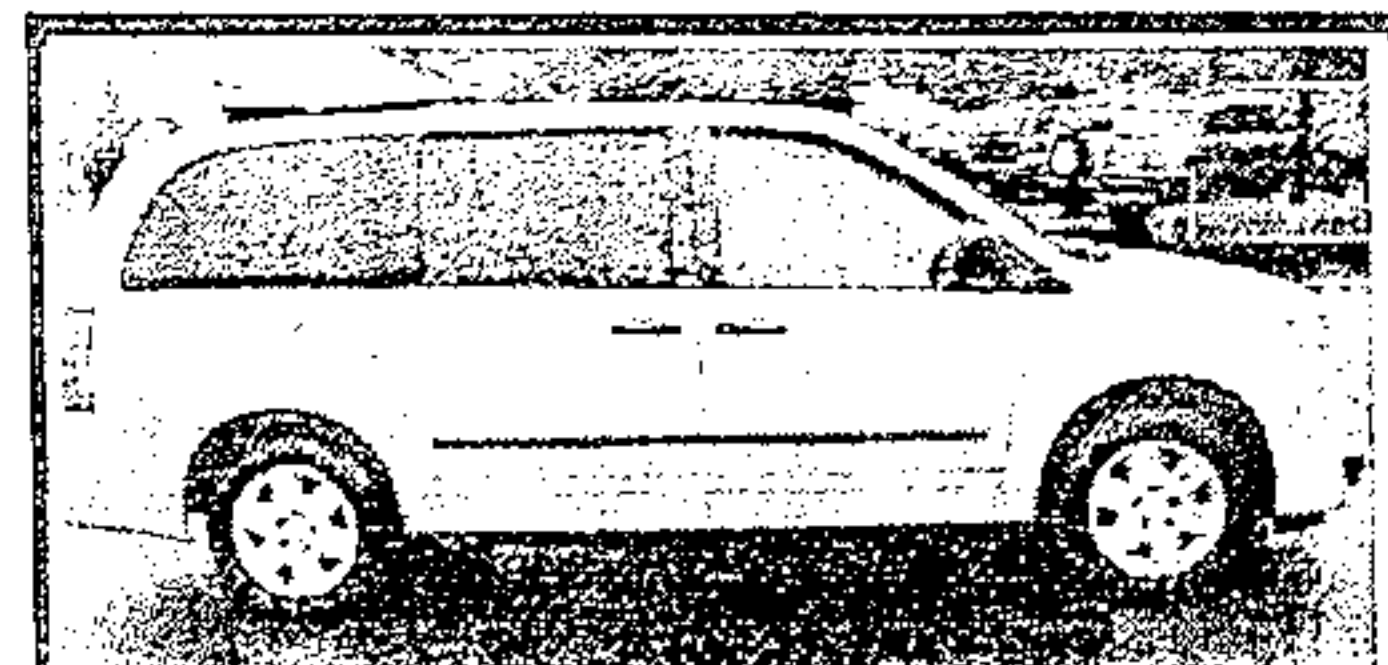

2008 Dodge Grand Caravan, Nice, Clean, Stow n Go!

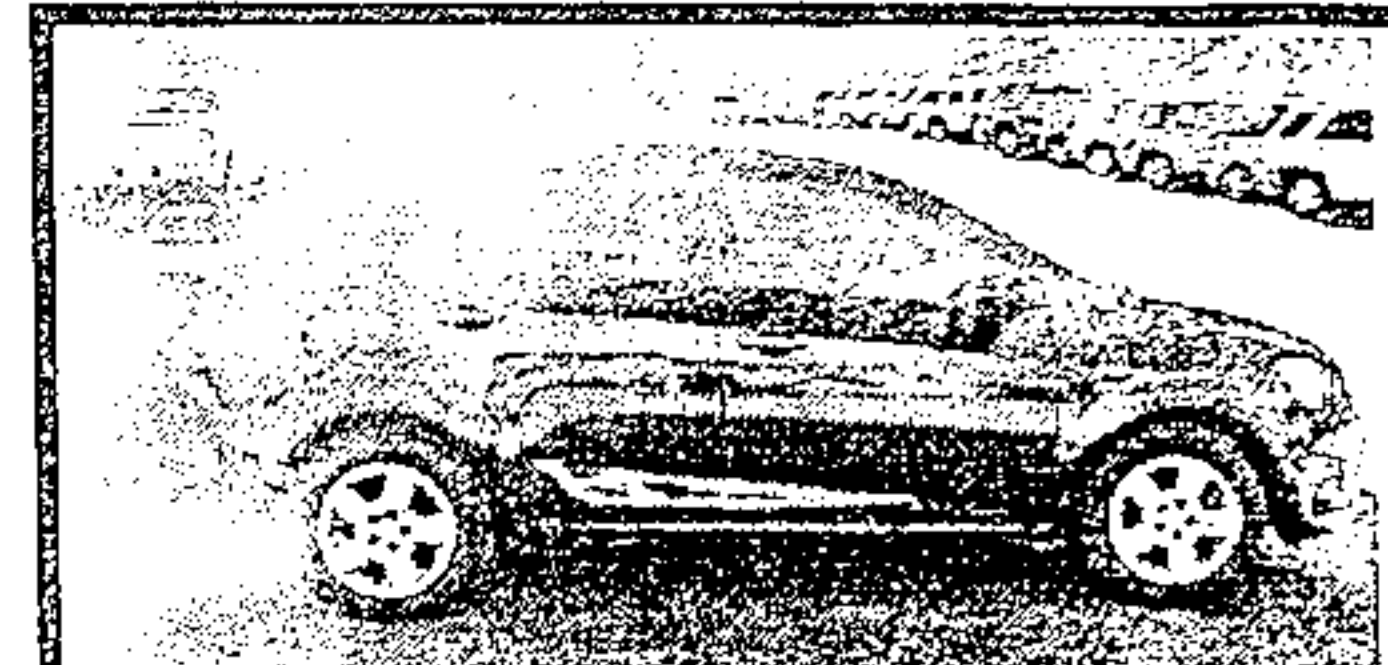

2014 Chevy Sonic, Factory Warranty, Low Miles!

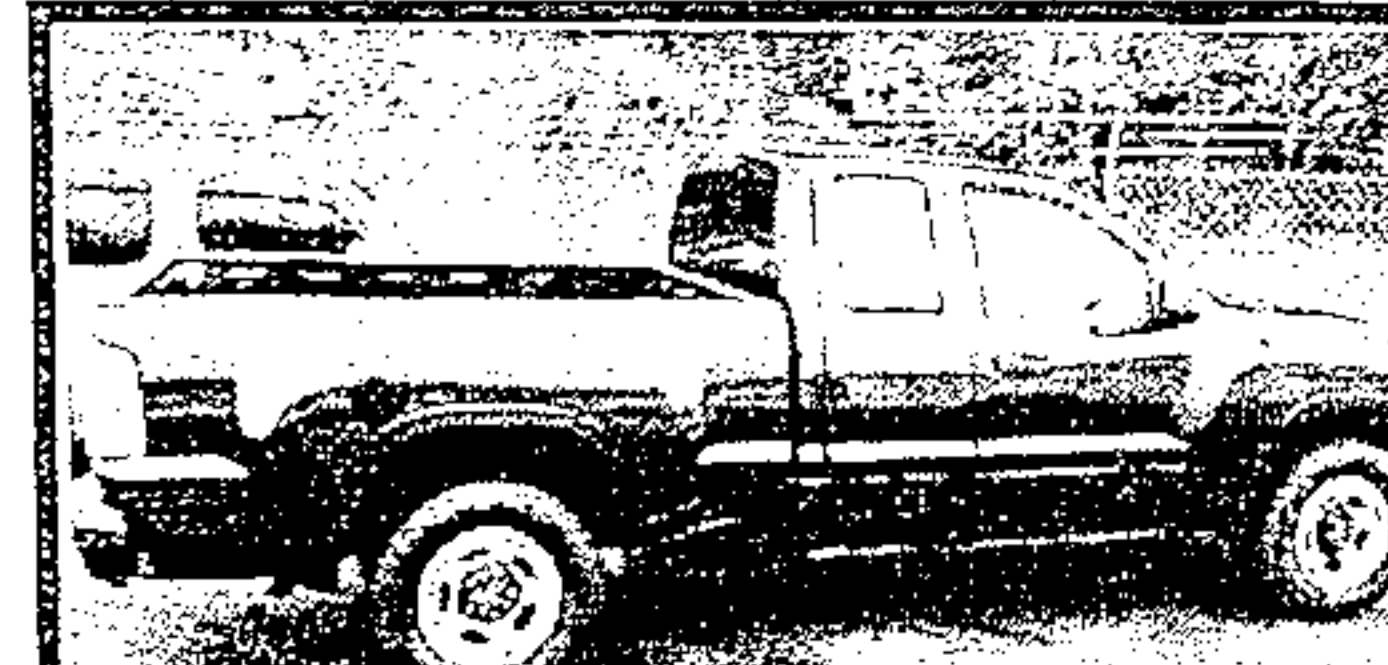

Mitsubishi Raider, Ext. Cab, Super Nice Truck

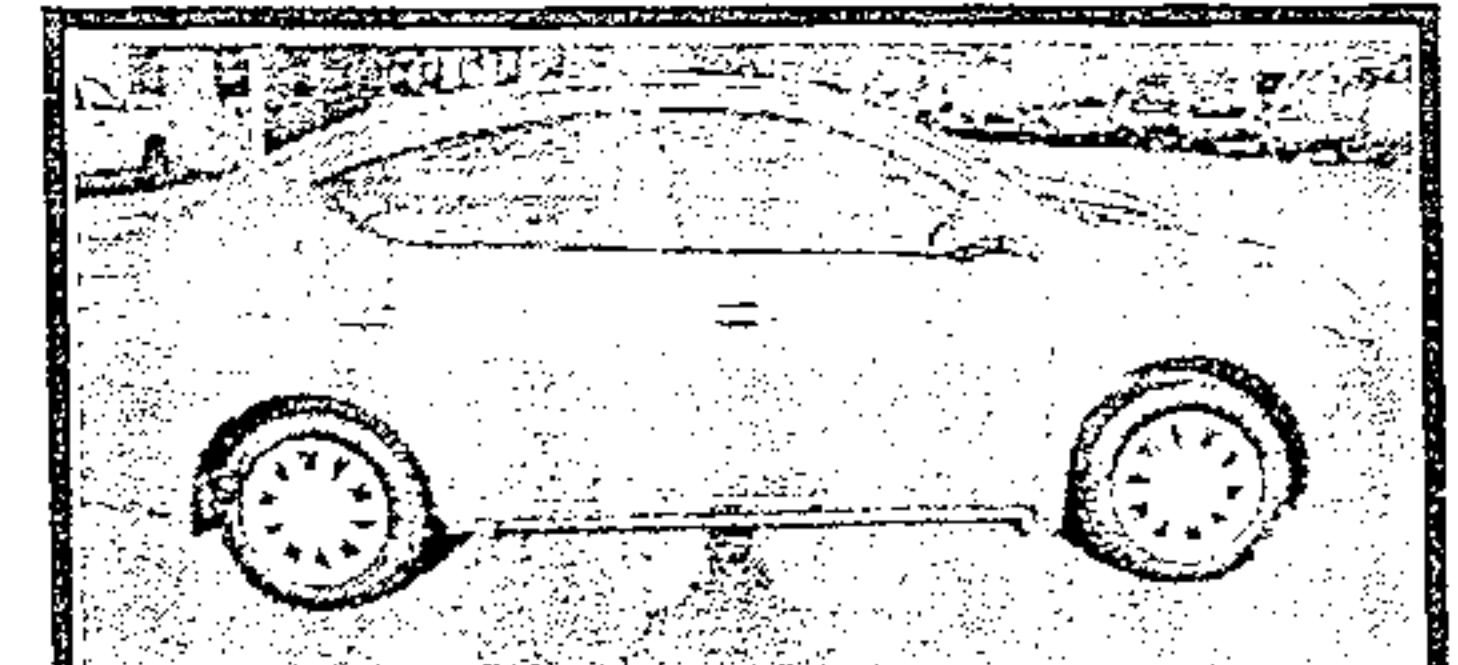

2013 Nissan Versa, Like New! LOADED!!!

WALT WILLIAMS, INC.

*with approved credit

3003 Highway 11 Lenoir City, TN 865-986-1111