

The Daily Edition

50¢

Serving Loudon, Monroe and Surrounding Counties

Thursday, February 25, 2016

Aggravated burglary involves gun and boat motor

Joshua Giles, 29, Carding Machine Road Loudon, was charged with Domestic Assault, Aggravated Burglary, Vandalism, Theft of Property, and Simple Possession. Deputy Jamie Ketner LCSO, Deputy Chrle Parker LCSO, responded to Prospect Church Road on an aggravated burglary call. Upon arrival Deputy made contact

(see burglary pg. 2)



Joshua Giles

Man breaks into apartment; tells officer it was his sister's stuff

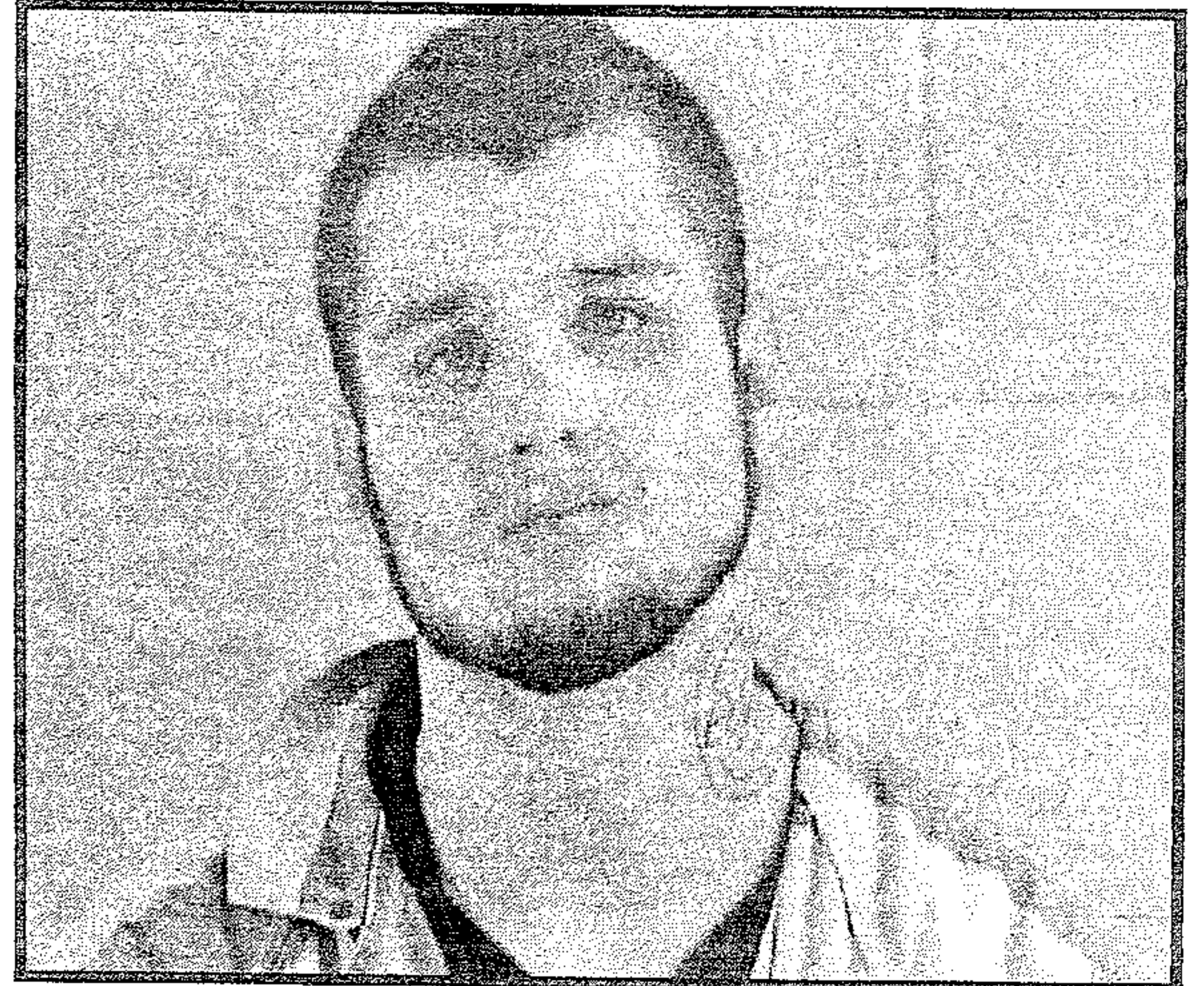

Dylan Ferguson

(see aggravated pg. 5)

Load of charges follow airborne crash into deck

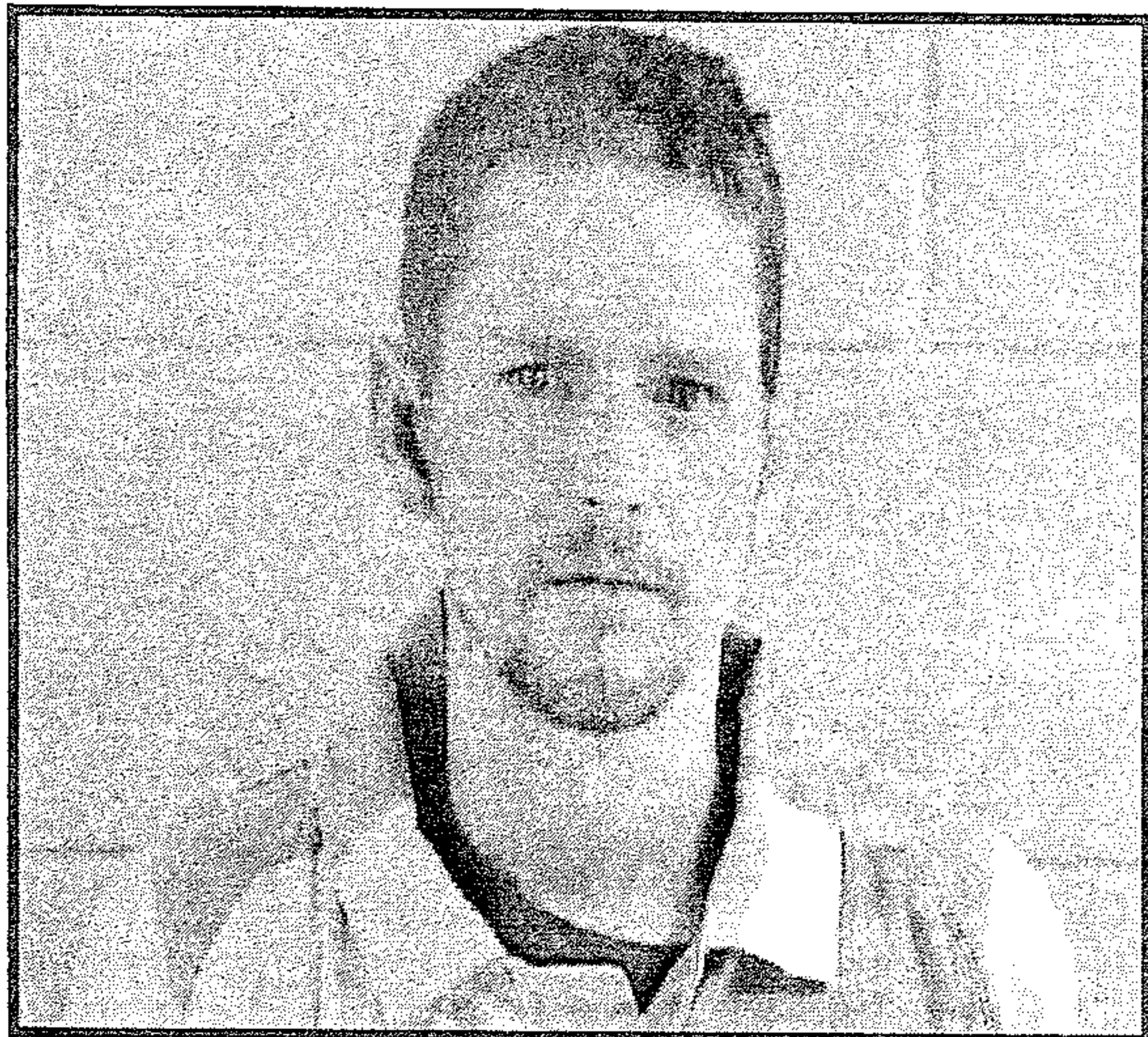

(see DUI pg. 7) Samuel Knox

Knoxville Stomp – an unprecedented “Festival of Lost Music” – comes to downtown Knoxville the first weekend in May

Headlined by Dom Flemons, the full lineup includes a diverse array of musicians, writers, scholars, and collectors

The Knoxville Stomp, May 5-8, 2016, is a live celebration of recordings made by local and regional artists in the summer of 1929 and spring of 1930, when the Chicago-based Brunswick record company came to Knoxville. They installed a studio in the St. James Hotel, which stood at the north end of Market Square, near where the TVA Towers stand today. Those

(see Stomp pg. 4)

Caught in the Act Prolific Washington State Bank Robber Sent to Prison

The masked criminal known as the Cyborg Bandit and, later, the Elephant Man Bandit was robbing Seattle-area banks at an average of more than two per month for an entire year before he was caught—in the act of robbing a bank he had already robbed.

For investigators who routinely work bank robberies, the story of 46-year-old Anthony Hathaway, sentenced last month to nearly nine years in prison, is surprising in some ways but all too familiar in others.

“In this particular case and in general, bank robbery is a crime of last resort,” said Len Carver, a detective with the Seattle Police Department and member of

(see FBI pg. 3)

Verse of the Day

For this reason a man will leave his father and mother and be united to his wife, and they will become one flesh. — Genesis 2:24

Obituaries

see inside

Wazzup

Did you know it was a federal crime to nap in the Smoky Mountains? No matter how bad the weather gets don't stop, according to Park Rangers!

Weather

Today: Cloudy. A shower of rain or wet snow possible. High 42F.
Tonight: Considerable cloudiness. A few flurries or snow showers possible. Low near 30F.
Friday Mostly cloudy skies early will become partly

cloudy later in the day. High 49F.

Friday Night Partly cloudy Low 29F.

Horoscopes

Pisces 2/19-3/20

You're riding an emotional roller coaster today, but if you go with the flow the

(Continued on page 6)



1 08805 93489 2

burglary

with the victim, who stated her husband identified as Joshua Giles, had come to her residence and forced his way inside past her, possibly intoxicated. Joshua does not live at this residence regularly. Once inside the home, Joshua became angry and attempted to go downstairs to get a boat motor. Victim

prevented Joshua from doing that, so Joshua went up stair and woke up their infant child.

Victim was able to get Joshua back down to the door where in great fear victim had to pull a gun to get Joshua to leave. Joshua then went and kicked the brand new basement door. The door was observed hanging by a single hinge. Joshua then took the

boat motor, and took it to his truck, victim went to the truck with a baseball bat and attempted to get the motor back. Joshua then went inside and got the gun and pointed at the victim. The victim ran inside, and Joshua left with

the gun.

Joshua had left the scene at time of report. Warrant was issued.

Deputy Jamie Ketner LCSO, arrested Joshua Giles and transported to Loudon Jail.

Notice: The Daily Edition does not knowingly accept fraudulent or misleading materials. The Daily Edition cannot guarantee the validity of offerings or statements contained herein. All liability for the contents of all advertising, and for any claims that may arise therefrom, is the responsibility of the advertiser or its agency. The Daily Edition reserves the right to reject, edit, or abbreviate any advertisement submitted. Advertising is accepted with the understanding that all liability for all copyright violations is the sole responsibility of the advertiser. Photographs, artwork and other copy submitted for publication is considered the sole property of the advertiser. The Daily Edition will make every effort but will not be liable for failure to publish and ad or for typographical and layout errors. All statements and information about highlights featured items, letters to the editor, herein are those solely given to the interviewer or writer and the Daily Edition assumes no responsibility of the accuracy or validity thereof. The Daily Edition will gladly reprint at no charge that part of an advertisement in which an error occurs provided a claim is made within 3 days of the first publication of the ad. Information contained in the Wazzup is received anonymously and the Daily Edition assumes no responsibility for information and reserves the right to edit or reject any and/or all submissions. The Daily Edition is a daily newspaper of general circulation in Loudon County defined under TCA 2-1-104(a)(13). The Daily Edition also serves Monroe, Knox, Anderson, Roane and Blount counties and serves 30,000 readers weekly. Send mail to PO Box 1240, Lenoir City TN 37771. 865-771-2249. email: dan1204us@yahoo.com

The Daily Edition is Loudon County's premier public interest and paid advertising paper. The Daily Edition is produced and published daily Monday through Friday and is circulated throughout Loudon County and parts of Monroe and Knox Counties. Display advertising rates \$5.00 per column inch and quantity discounts available. Call for information on upcoming promotions and events.



HACIENDA Ayala's
Mexican Restaurant
 Market Dr. * Lenoir City (In Front of Food City)

Real Authentic Mexican Food at Affordable Prices

BEST
MARGARITA









**You've Tried The Rest
 Now Come Have The Best!!!**

We Accept ALL Competitors Coupons Outside of Mexico City!

986-3553

Good Credit OK • Bad Credit OK • Bankruptcies OK • Repo OK

 <p>2010 Kia Soul Sporty, 4 cyl, Auto, PW, PL, A/C, Great On Gas, Like New</p>	 <p>2010 Ford Escape Limited Leather, Alloy Wheels, Heat, A/C, Luggage Rack, 79K,</p>	 <p>2007 Dodge Ram 1500 Quad Cab, Thunder Road PKG, 20 in. Wheels, Low Miles, Hemi</p>
 <p>2008 Ford Explorer 84k, 3rd Row Seating, Luggage Rack, Tow Pkg, PW, PL</p>	 <p>2011 Ford Ranger Low Miles, Tow Pkg, New Tires, A/C, Heat, Bed Liner.</p>	 <p>2011 Dodge Grand Caravan DVD, Stow & Go, Loaded, Remote Doors, Rear A/C</p>

DEPENDABLE MOTORS 986-9343

803 E. Broadway • Lenoir City

* WAC. See Dealer for details Visit our website at: www.dependablemotorslc.com

Serving Loudon County for 20 Years

FBI

the FBI's Seattle Safe Streets Task Force. "Occasionally you get a thrill seeker or a truly violent individual, but most people who rob banks are supporting an addiction of some kind—drugs or gambling—and they

are desperate."

Hathaway's addiction was to prescription painkillers and then to heroin. According to court records, he suffered an injury and became addicted to the opiate Oxycontin. After losing his job, he turned to crime to feed his addiction, and between February 2013 and February 2014, Hathaway admitted to 30 bank robberies. He sometimes hit the same bank multiple times.

"Seattle has had many serial bandits over the years," Carver said, "but Hathaway was prolific. He might top the list for sheer number of robberies in a one-year period."

During the holdups, which usually occurred late in the afternoon, Hathaway wore a mask and gloves. In the early crimes, he wore textured metallic fabric over his face and was nicknamed the Cyborg Bandit

because the disguise was similar to that of cyborgs in science fiction productions. After that disguise began receiving too much media attention, he covered his head with a shirt and cut out two eye holes. That earned him the nickname the Elephant Man Bandit because of the similarity to a movie character of the same name.

In several robberies, Hathaway threatened tellers, saying he had a weapon, although no

weapon was ever displayed. On February 4, 2014, after a robbery in Lynwood, Washington, surveillance video showed what might have been the robber's getaway vehicle: a light blue minivan with a Seattle Seahawks football decal on the back window and an unusual, after-market exterior mirror.

A bulletin with the vehicle's description went out to area law enforcement, and an Ev-

(see FBI ctd. pg. 5)

For Sale: oak Wood Mulch



Mushroom Compost Topsoil.



Firewood

Call Steve Spoon
986-4282

West End Storage & Warehouses
502 Ward Avenue • Loudon
Call 865-458-4774 or 865-679-5555

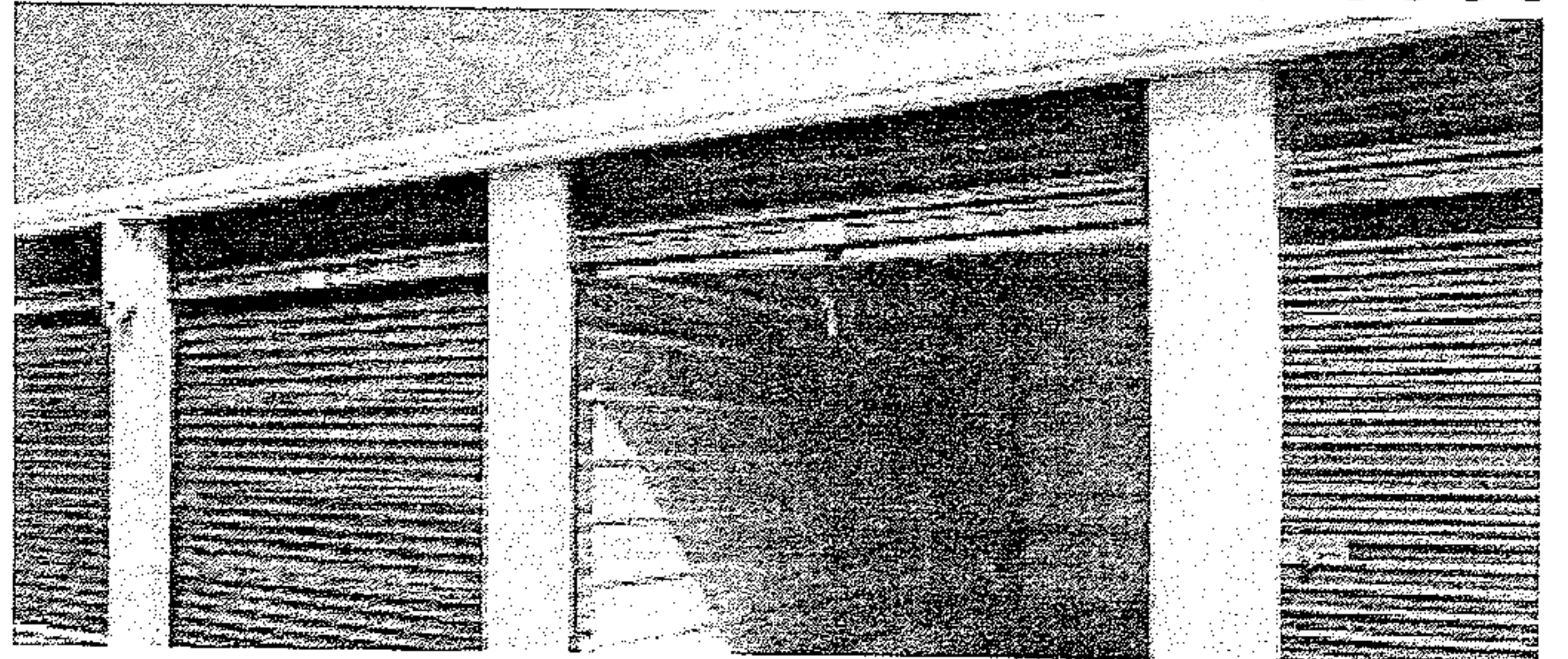

STAINED INK

TATTOO & PIERCING
LENOIR CITY 865 816-6440
NEW OWNER • NEW ARTIST • SINCE 2011
521 Hwy 321 next to Vape & Stuff & Inn Of Lenoir!
Clean-Affordable-Quality-Custom
Tattoo's You've Always Wanted!

BRING IN THIS AD FOR **\$25 OFF!**
NEW INK FOR NEW CUSTOMERS ONLY!

Check us out on FB.com/
Stained.Inc.Tattoo/
www.STAINEDINC.com

C&J Towing and Recovery

LOWEST TOWING RATES AROUND!!!

Have you been overcharged for any type of towing service in the Lenoir City area? If you have a breakdown or accident please OWNER REQUEST C&J Towing with the officer. Also please call your Sheriff and ask him to place C&J Towing on the "Rotation List*" and help other motorists save as much as you did! We at C&J are locally owned and operated, State approved, licensed, bonded and insured. Call and let us know if your denied service or how we can be of assistance.

*note: the "Rotation List" is a list of wrecker services that provide service for wrecks, DUI's, breakdowns, etc. and are on an on-call basis for service. This list is approved by the Sheriff.

Cliff Teeters • Owner
865-809-1661

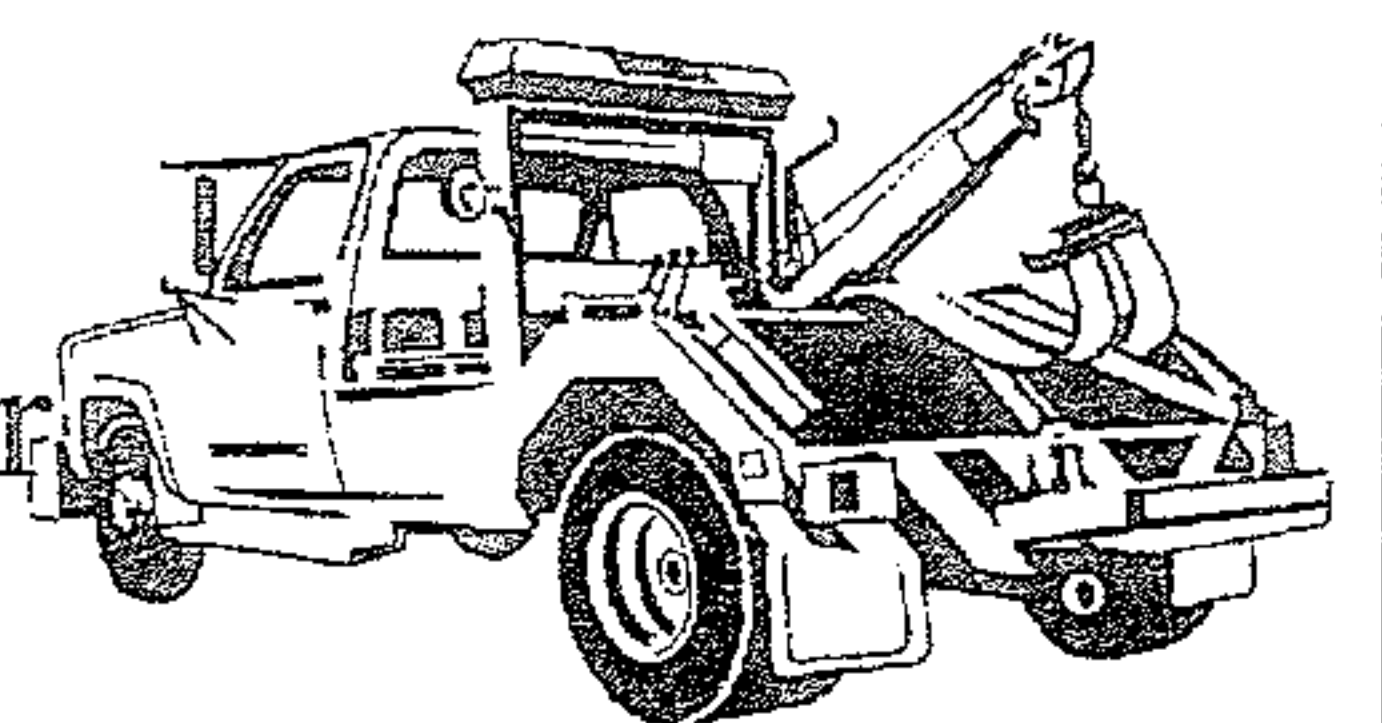

BIMBO'S

Deli Open 24 Hours
865-986-9643 Call Ins Welcome

Specials
Lg. Cold Sub, bag of chips and 16 oz. fountain drink
only \$6.29
Footlong Corn Dog \$2.59

stomp sessions, many of which have been lost for years, are being released this spring in a boxed set called Knox County Stomp: The Knoxville Sessions 1929-1930 by the prestigious German label Bear Family Records.

The Knoxville Stomp will be one-of-a-kind weekend, bringing a diverse array of musicians, writers, scholars and collectors together in Knoxville, Tennessee, from May 5-8, 2016.

"When we announced that these lost recordings were going to be re-released in May, it

was like we'd turned on a tractor beam for musical historians and re-creators of historical music. This is a really big deal! Be ready for the best in old-time, vintage jazz, and country blues, and gospel music. Local bands and historians along with those coming from all over the world are ready to put on quite a show to honor this special occasion!" says Matt Morelock, Production Manager for the Knoxville Stomp.

The Knoxville Sessions produced 101 commercially released tracks, featuring both African-American and white artists in a range

of genres - gospel, string bands, blues, jazz. Collectively, they provide a panoramic view of Southern Appalachian music and culture on the cusp of the Great Depression.

The Knoxville Stomp festival will feature live performances of many of the historic tracks, along with other music from the era, panel discussions, film screenings, a 78rpm record collector show, and more. The Stomp will take place in venues throughout downtown Knoxville, including Market Square, the Bijou Theatre, the East Tennessee History Center and Boyd's Jig and

Reel among others. Most Stomp events will be free and open to the public, with tickets for a select few events going on sale February 25 at www.knoxstomp.com.

The Knoxville Stomp is being presented by the Knox County Public Library's Tennessee Archive of Moving Image and Sound, WDVX Radio, the East Tennessee Historical Society and Visit Knoxville. The Knoxville Stomp is part of Knoxville's 225th Anniversary celebration, which will highlight the city's history throughout 2016. For more information about the festival, see knoxstomp.com

(see stomp ctd. pg. 5)

Public Notice
The Loudon County Corrections Partnership Committee will meet March 2nd, 2016 at 12:00 at the Justice Center to discuss future plans.

APPLY FOR AN EASY ADVANCE AND GET MONEY FAST!

\$750 Easy Advance at Liberty Tax at No Additional Cost!



820 Hwy 321 N Across from Burger King
119 E. Broadway Street Downtown Hwy 11

Lenoir City, TN 37771
865-986-8335

An Easy Advance (EA) is a \$750 loan secured by your tax refund and is offered by Republic Bank & Trust Company, member FDIC, to qualifying applicants. There are no fees or interest associated with the EA. Subject to approval. Visit your Liberty office to learn more. Offer Expires 2-28-15.

BUDGET
Transmissions



302 S. Northshore Drive Knoxville

(865) 584-4391 budget-transmissions.com

Why Buy From Budget?

Free Towing From Lenoir City or Loudon County

20 Years of BBB Zero Customer Complaints Award Member

A+ Plus Rated

Huge Transmission Inventory

Best Technicians Period!!!

Call (865) 584-4391 Today!



Approved Auto Repair



good to know you™

IMMEDIATE OPENINGS!

Randstad is NOW HIRING for 2nd shift Assembly Positions at Commercial Vehicle Group. These are long-term, temp-to-hire positions!

Hours: 4:30pm - 3:30am (end times vary)

Pay: \$10/\$10.50 per hour

You may apply by visiting our Facebook page www.facebook.com/vonorejob and clicking the "Sign Up" button. You can also get a paper application from the Guard Shack at 200 National Drive, Vonore, TN 37885.

For questions, call 423.884.4733

www.randstadstaffing.com

EOE

randstad

Staffing | Professionals | Search & Placement | HR Solutions | Inhouse Services

aggravated

Dylan Ferguson, 22, Abbott Road Lenoir City, was charged with Aggravated Burglary. Officer Nick Hasley LCPD, responded to Kelly Lane in reference to Dylan Ferguson stealing items from a residence. Upon arrival Officer observed Dylan attempting to drive away from the residence. Upon Officer exiting his patrol

car, Dylan exited his vehicle. Officer asked Dylan what he was doing, Dylan stated he was removing some of his sister items from her residence. Officer advised Dylan that his sister has not lived there in over a month. Victim stated that all the items Dylan took belonged to her. Dylan was placed under arrest. Officer Nick Hasley LCPD, made the arrest.

stomp ctd. from pg. 4

tomp.com.
Highlights include:
Dom Flemons -- The musician, scholar and cofounder of the popular Carolina Chocolate Drops will take to the Bijou Theatre stage to celebrate old time music and share some of his favorite 78rpm records with the audience
Amanda Petrusich -- The NYU faculty member and author of Do Not Sell at Any Price:

The Wild, Obsessive Hunt for the World's Rarest 78rpm Records will present a reading and Q&A session
The Down Hill Strugglers -- The Brooklyn-based old time string band works to carry the music of the old rural America forward with verve and creativity. They were featured on the soundtrack to the Coen Brothers film Inside Llewyn Davis, produced by T-Bone

Burnett.
Joe Bussard -- The world's foremost 78rpm record collector will discuss his lifelong obsession with American music of the 1920s and 1930s.

Roochie Tootie and the Ragtime Shepherd Kings -- This wild, New Orleans-based quintet seeks out weird, wonderful songs from the early days of Tin Pan Alley.

Elijah Wald -- The blues musician, historian and author of last year's Dylan Goes Electric!: Newport, Seeger, Dylan, and the Night That Split the Sixties will discuss the history of remote and field recordings in American music

Georgia Crackers -- The premier North-Georgia old time string band will feature special guest Dub Hudson on clarinet.

Full lineup of musicians and presenters:

- Musicians:
The Bearded
Bill and the Belles
The Carolina Cud Chewers
The Corn Potato String Band
The Down Hill Strugglers
Matt Downer
ETSU Old Time Pride Band
Dom Flemons
Matt Foster
Eli Fox
Frog and Toad's Dixie Quartet
Gammon, Horton and Reynolds
Georgia Crackers
God's Gospel Singers
The Hellgramites
Hunter Holmes
Kelle Jolly and the Will Boyd Project
Matt Kinman
Knox County Jug Stompers
The Knoxville Banjo Orchestra
Alex Leach
Sean McCollough with students from South Knoxville Elementary School
The Mumbillies

(see stomp conc. pg. 8)

PURDY'S AUTO PARTS AND SALVAGE

WE BUY SCRAP IRON • COPPER • BRASS • ALUMINUM

\$

Paying Top \$\$\$

Call For Latest Prices

You Name It, We Buy It!

Radiators, Wheels, Batteries, Appliances, Farm Equipment

Copper

Paying Top \$\$\$

Call For Latest Prices

You Call We Haul!

423-519-5402

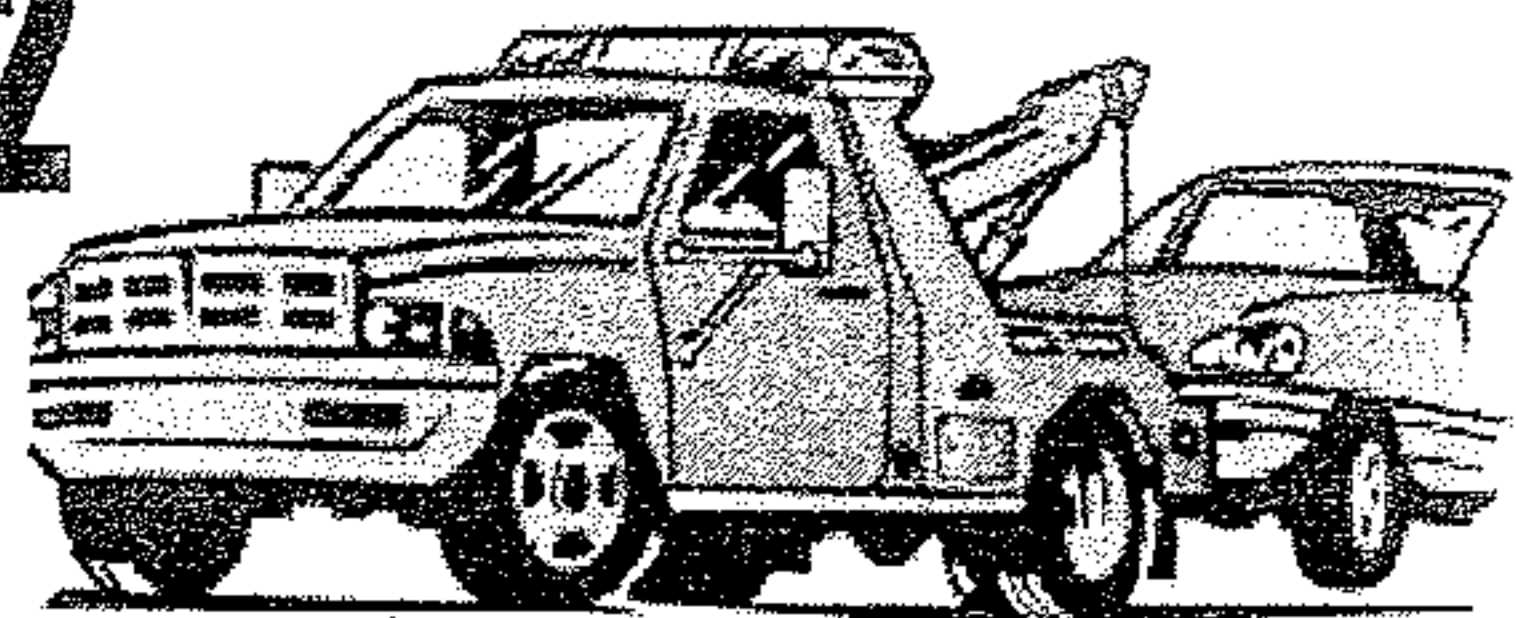

* Prices subject to change with the market.

423 337-3977

149 County Road 323 Sweetwater

* Prices subject to change with the market.

Complete Cars
per 100 lbs.

Scrap Metal

Paying Top \$\$\$

Call For Latest Prices

per 100 lb

We Buy Batteries

Aluminum Cans

Paying Top \$\$\$

Call For Latest Prices

**Now Selling
Aftermarket
Body Parts at
Discount Prices**

gun

Samuel Knox, 30, Homeless, was charged with DUI, Driving on Revoked /Suspended License, Leaving the Scene of an Accident, and Violation of Implied Consent. Trooper Paul Clendenen THP. Trooper was dispatched to a vehicle to a vehicle versus residence crash. Trooper arrived on scene and observed a that a vehicle had struck a tree stump, ran a stop sign and gone airborne before striking a deck at Spring Street. The driver fled the scene. The vehicle had a strong odor of intoxicant. Loudon Co. Dep-

uty located the driver Samuel Knox at a near by residence on Knox Street. Deputy made contact with Samuel who had red watery eyes, and a strong odor of intoxicant coming from his person. Samuel kept falling asleep while Deputy was talking with him. Samuel was placed under arrest. Trooper Paul Clendenen THP, made the arrest.

Ads starting at only \$1 per day.
Call 865-771-2249

Help Wanted
Position Available Immediately! Apply in person at the Kenjo Marathon on Hwy 321 in Lenoir City.

FBI ctd. from pg. 3

erett Police Department officer spotted it several days later and notified investigators. "An officer on patrol was being observant," Carver said. "It was a key moment in the investigation."

At that point, however, the bank robber's identity was still unknown. The vehicle was not registered to Hathaway, and several people had access to it. FBI agents began surveillance, and on February 11, 2014 they observed a man drive away in the vehicle.

The driver spent several hours circling a Seattle bank that had been previously robbed. "It seemed clear he was going to rob the bank," Carver said, "and we

had a high confidence that whoever was driving the van and about to rob that bank was going to be good for the other robberies."

Finally, Hathaway parked and pulled a mask over his face as he entered the bank. FBI agents and task force officers were there to arrest him moments later. Hathaway was identified

and later admitted to the 30 robberies. In a plea arrangement concluded last month, he was sentenced to 106 months in prison.

"We are grateful that the Safe Streets Task Force was able to close all these robberies," Carver said. "And we are pleased that Hathaway is no longer a threat to the community."

LONNIE JONES OPTICAL DISPENSARY

"We Make The Difference You Can See"
Locally Owned and Operated

Over 1000 Frames To Choose From
No Frame Over \$69.00



On the corner of A & Depot Street, Lenoir City

986-7803

Serving Loudon County for over 40 years

LOOK!

\$75 Weekly Payments

LOOK!

MARTY'S AUTO SALES • 986-2222 • MARTY'S AUTO SALES • 986-2222 • MARTY'S AUTO SALES • 986-2222 • MARTY'S AUTO SALES • 986-2222 • MARTY'S AUTO SALES • 986-2222 • MARTY'S AUTO SALES • 986-2222

- Bad Credit
- Divorce
- Fixed Income
- Repos
- Bankruptcy
- No Credit



APPROVED!

NO CREDIT CHECKS

Visit Us On The Web At:
martysautosales.net

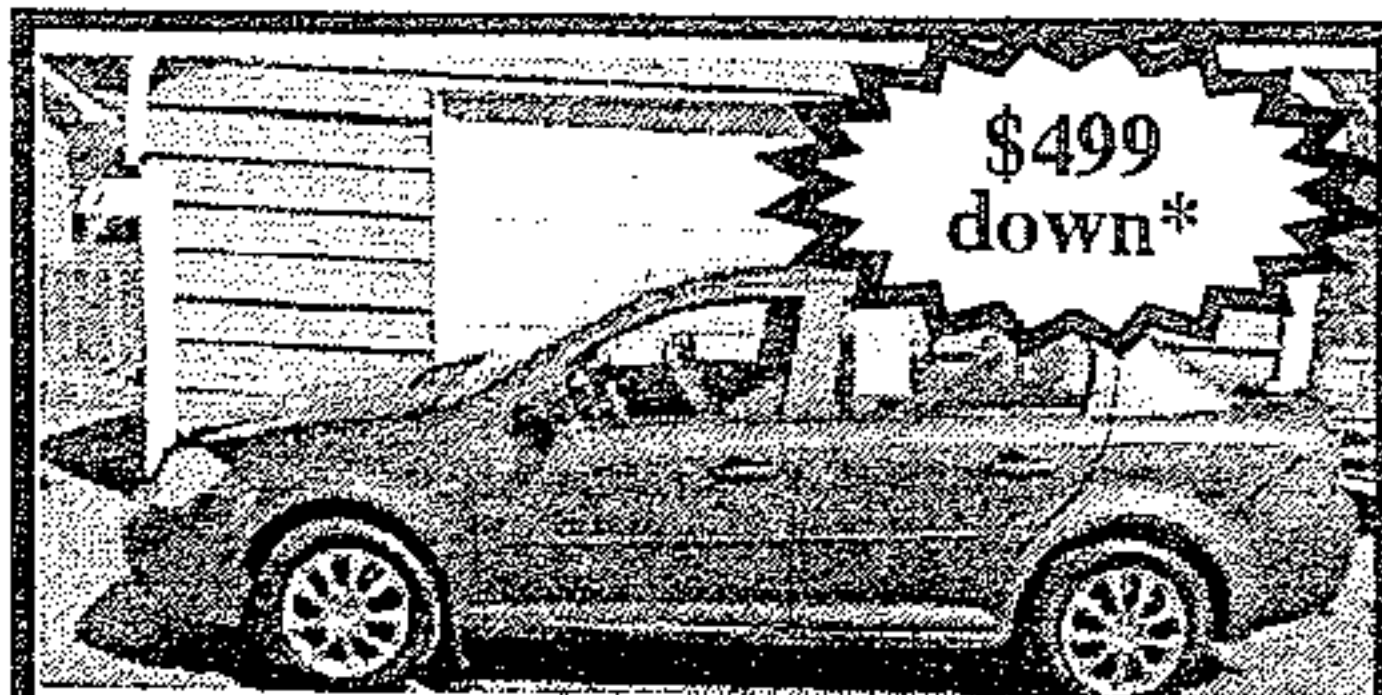

\$499 down*

07 Cobalt, 5spd, gas saver, runs great Only \$499 down*

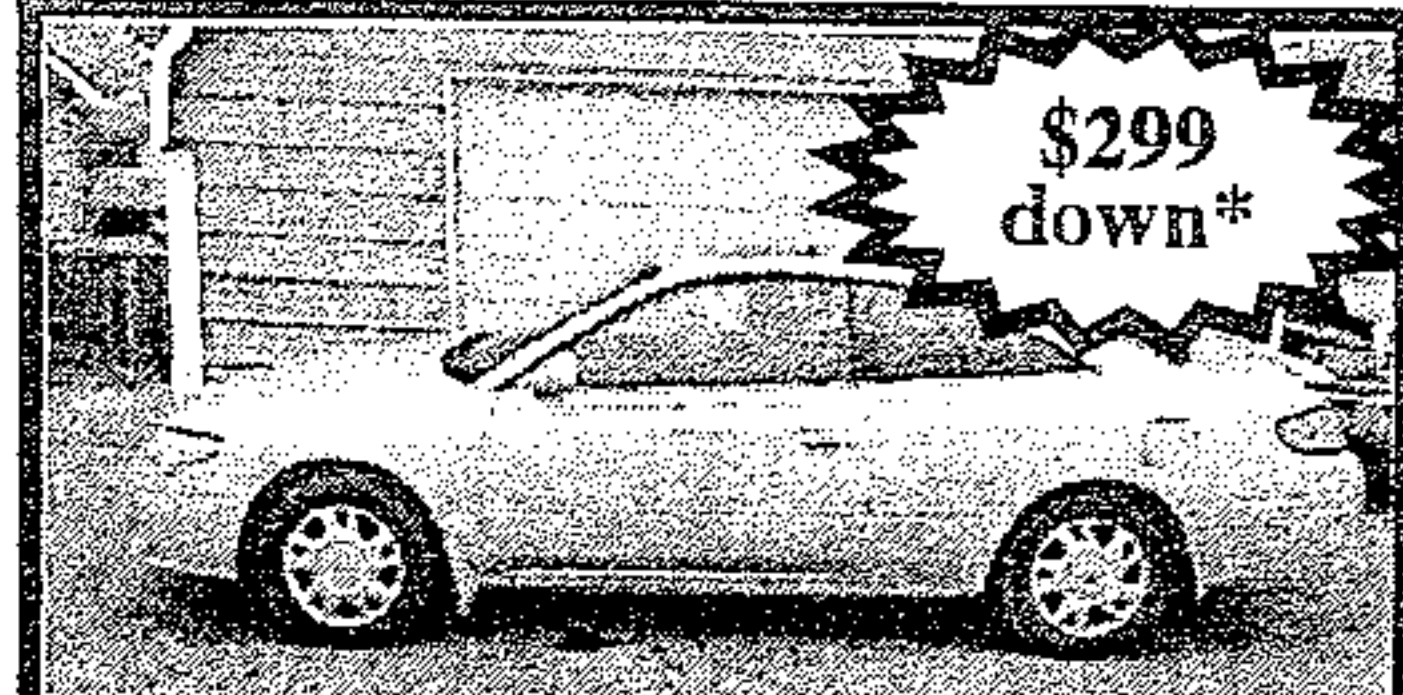

\$299 down*

99 Solara, V6, auto, sporty, Only \$299 down*

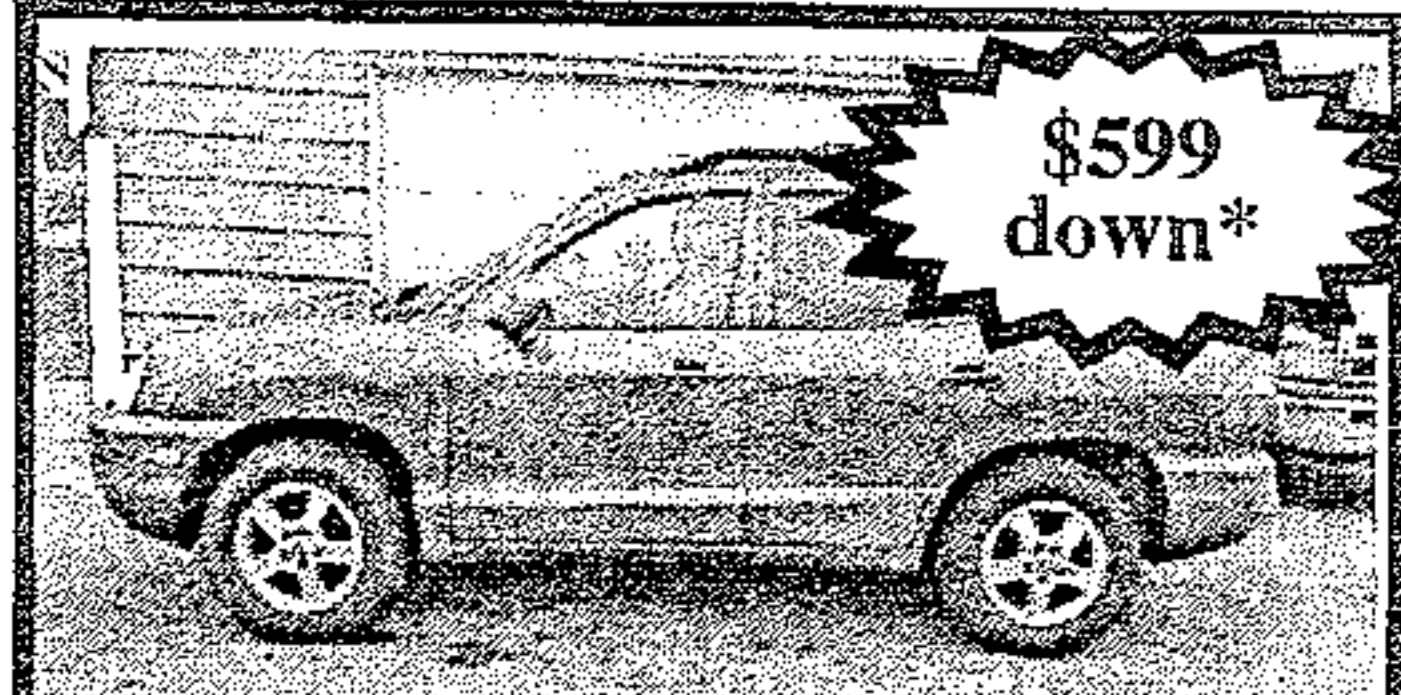

\$599 down*

04 Santa Fe, auto, Nice, clean, Only \$599 down*

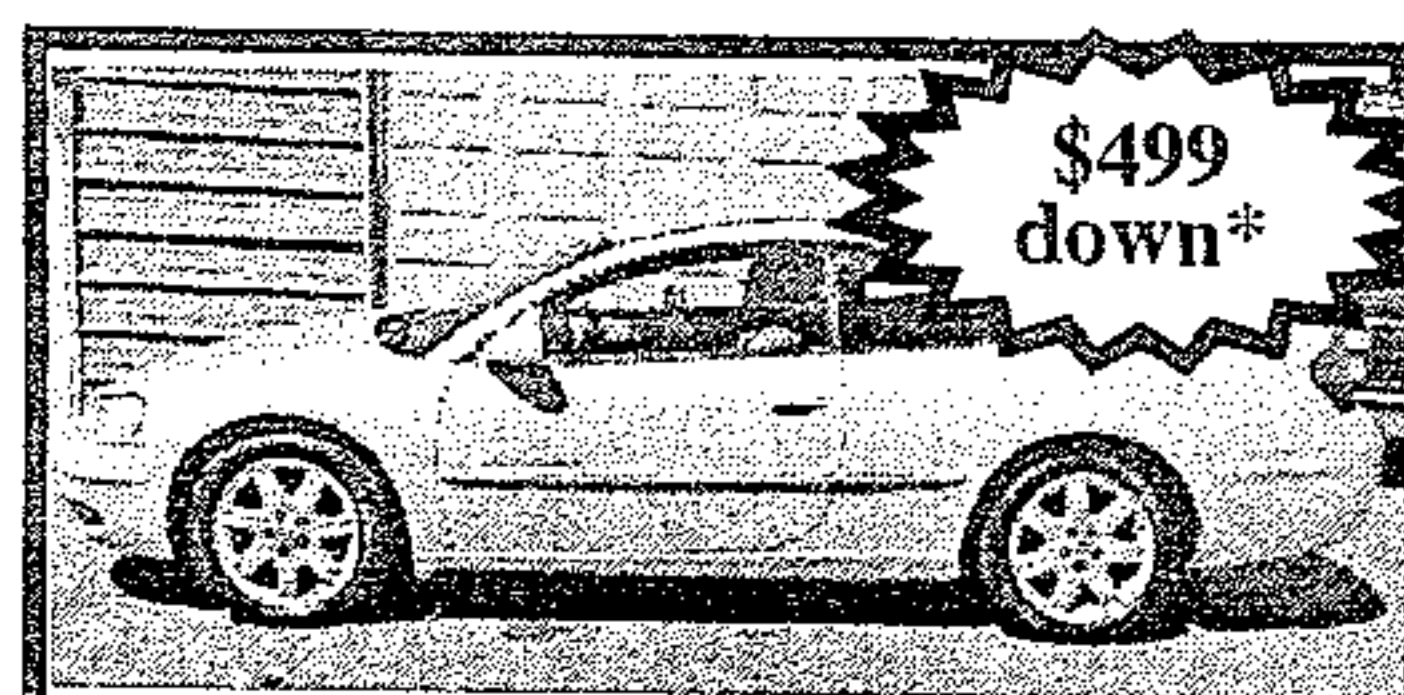

\$499 down*

01 Sebring 2dr. sporty, Only \$499 down*



\$599 down*

05 Trailblazer, auto, good miles Only \$599 down*



\$499 down*

04 Aveo, auto, gas saver, Only \$499 down*



\$799 down*

06 Tiburon GT, 5 speed, sporty, Only \$799 down*



\$99 down*

98 Bonneville, 6 cyl, Auto, low payments only \$99 down*

NO Credit Checks

Marty's Auto Sales
986-2222

Se Habla Espanol

100% Approval*

*See Dealer for details. All down payments plus tax, tag, title and fees.

MARTY'S AUTO SALES • 986-2222 • MARTY'S AUTO SALES • 986-2222 • MARTY'S AUTO SALES • 986-2222 • MARTY'S AUTO SALES • 986-2222 • MARTY'S AUTO SALES • 986-2222 • MARTY'S AUTO SALES • 986-2222

stomp conc. from pg. 5

John Myers Band
 Old Time Travelers
 Roochie Tooohie and the
 Ragtime Shepherd Kings
 Todd Steed
 The Streamliners Swing
 Orchestra
 The Tennessee Stifflegs
 Uncle Shuffelo and His
 Haint Hollow Hootenanny
 Kukuly Uriarte
 Panclists and Presenters:
 Joe Bussard

Eric Dawson
 John Fabke
 Martin Fisher
 Lance Ledbetter
 Jack Neely
 Ted Olson
 Amanda Petrusich
 Bradley Reeves
 Tony Russell
 Nancy Brennan Strange
 Elijah Wald
 Richard Weize
 Marshall Wyatt
 Jerry Zolten

THE RELIC SHOP

521 Hwy 321 Lenoir City Suite 3
 next to Stained Inc and the Inn of Lenoir
865-250-9280

WE ARE IN TUCSON, ARIZONA BUYING UP FOSSILS
 FOR THE SHOP. WE NEED TO MAKE ROOM!!!

ALL AMETHYST 40% OFF

GREAT SELECTION OF ANCIENT MEGALODON
 SHARK TOOTH OVER 8 MILLION YEARS OLD

Is Your Washer Broken?

Call Me

I Only Charge \$100 Period!!!

Call Allen

865-617-7113

A Name You Already Know And Trust Just Got Even More Dependable

DEPENDABLE AUTO SERVICE, LUBE AND TIRES

is Now Offering

Expert, Affordable Transmission Service

All ASE Certified Technicians

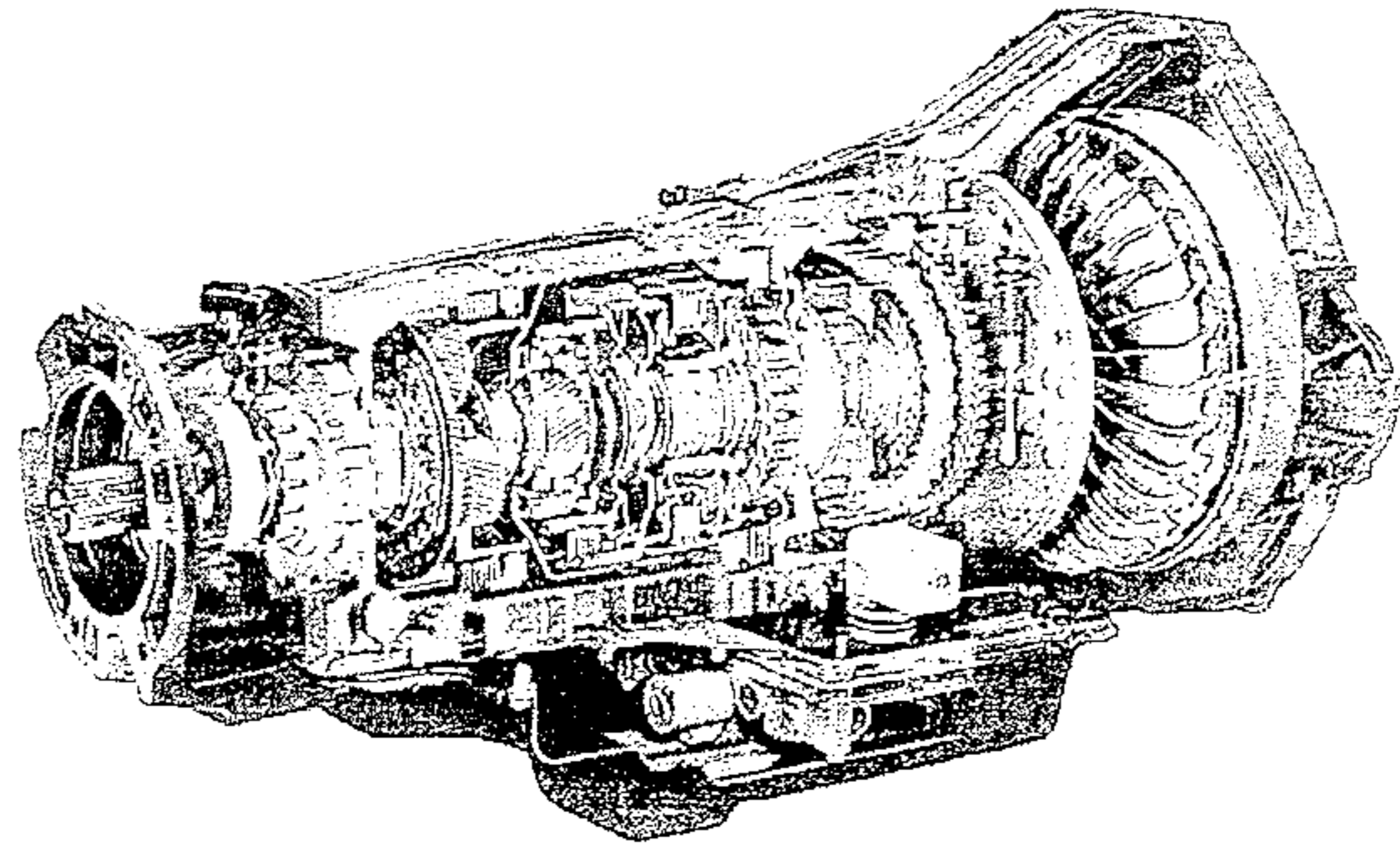

We proudly welcome all New Customers
 and Former Advanced Transmission
 Customers with a 10% Discount and Any
 Transmission Service or Repair*

865-986-9359

865-986-5050

Bad Credit, No Credit OK!!! We Finance Everybody!!!

Taxes Done Here!!! Bring your last pay stub or W2 and DRIVE TODAY!!!

Over 100 Cars, Trucks & Vans in Stock - Warranties On ALL Vehicles Sold!!!

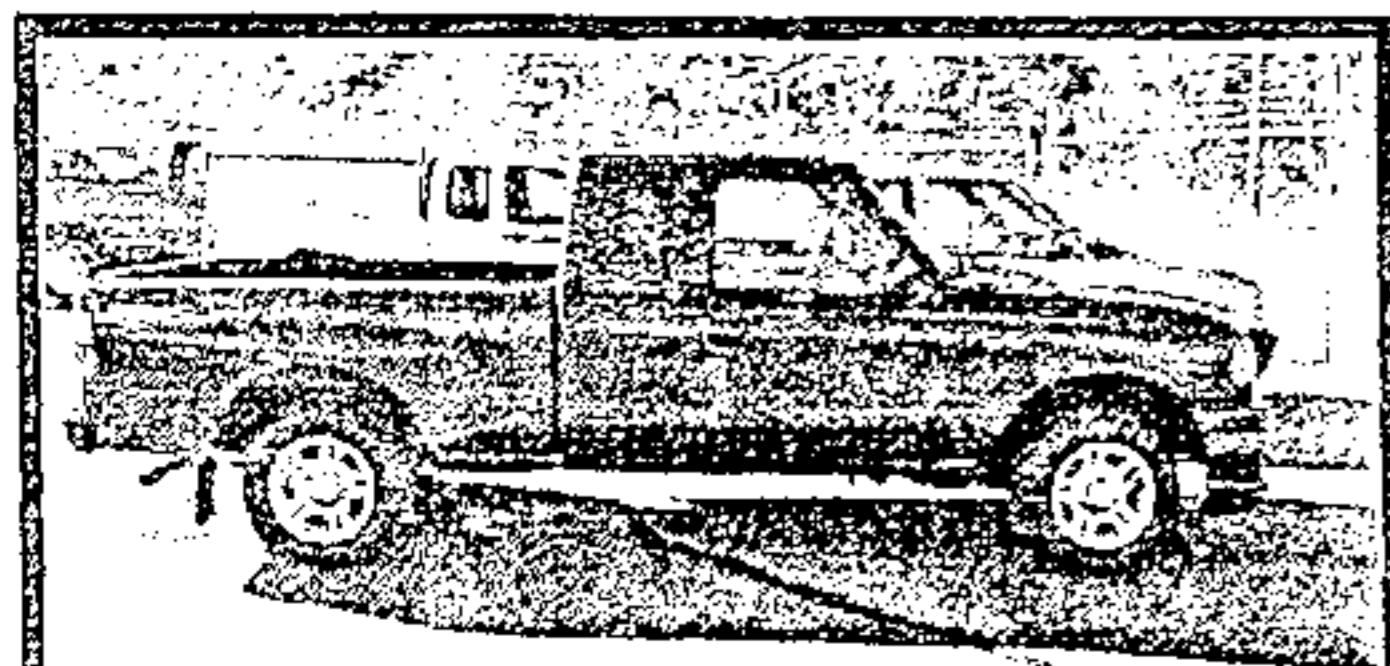

2005 Ford Ranger, Super
 Nice Truck, Very Low Miles



2015 Nissan Versa Note, Fac-
 tory Warranty, Low Miles

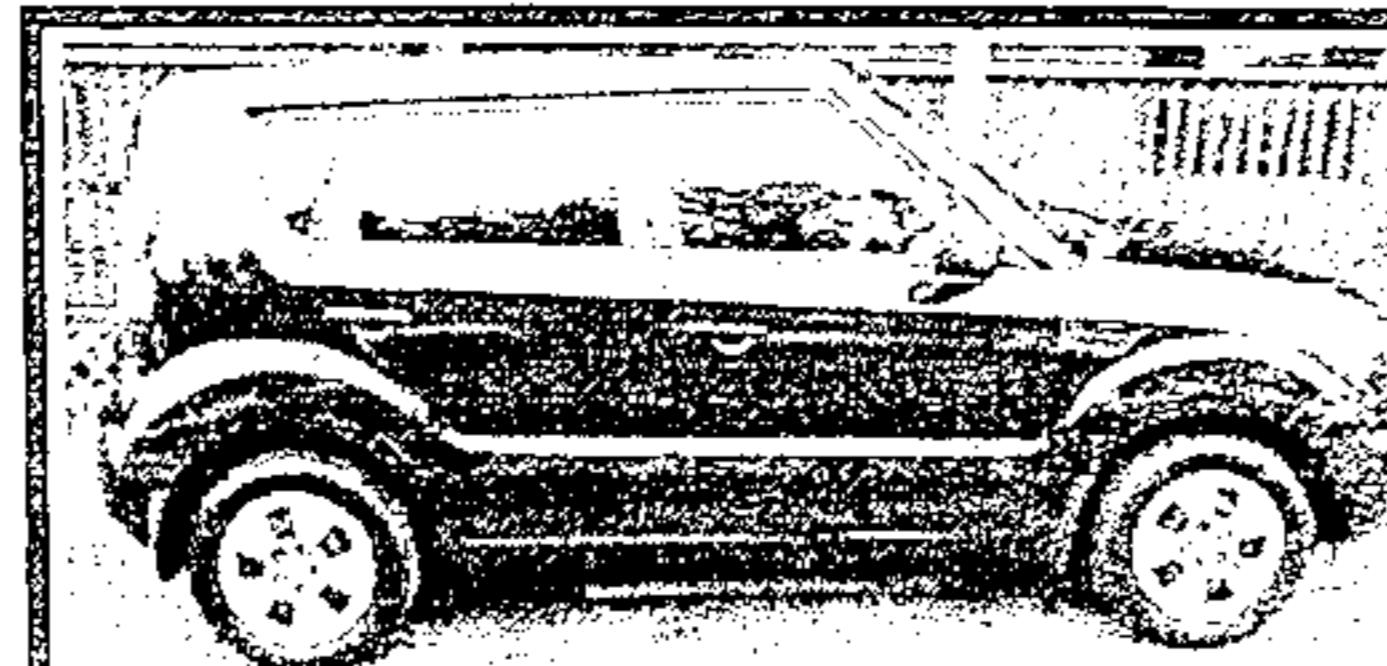

2011 Kia Soul, 5 speed, 4 dr,
 Gas Saver, Nice & Clean

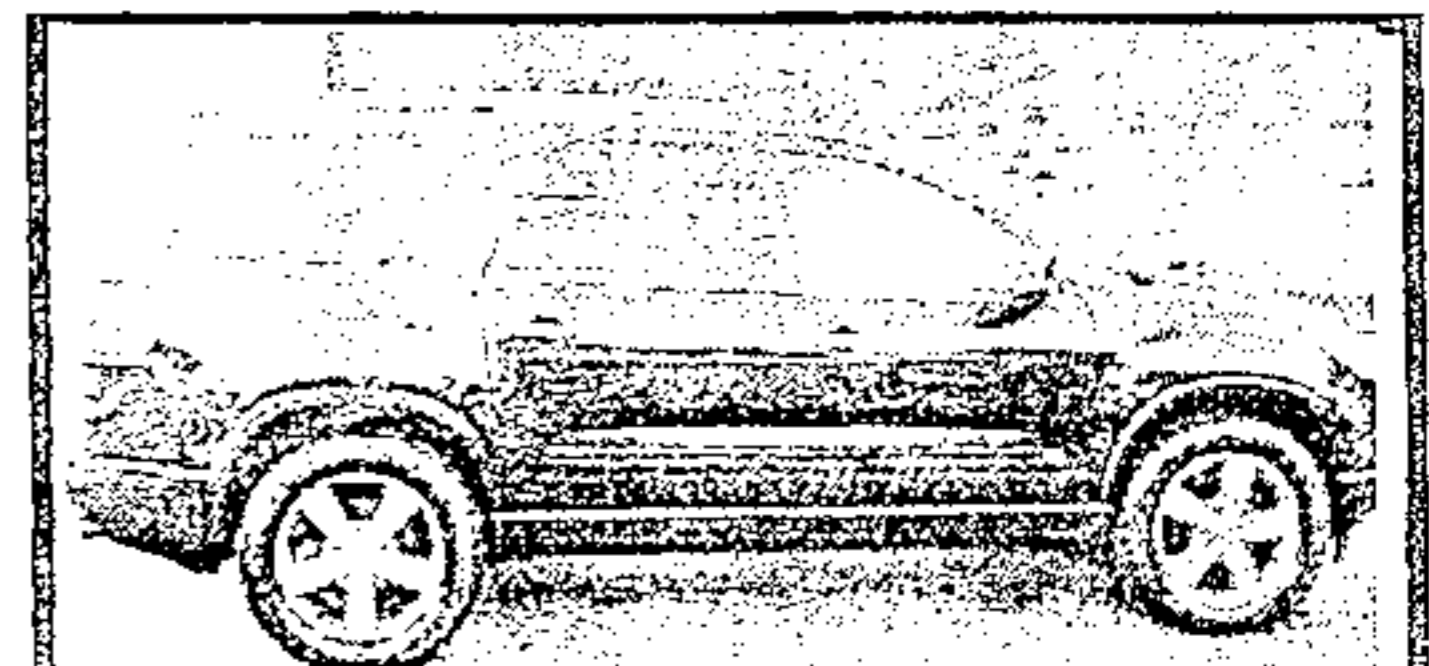

2010 GMC Acadia, LOADED!!!
 Sunroof

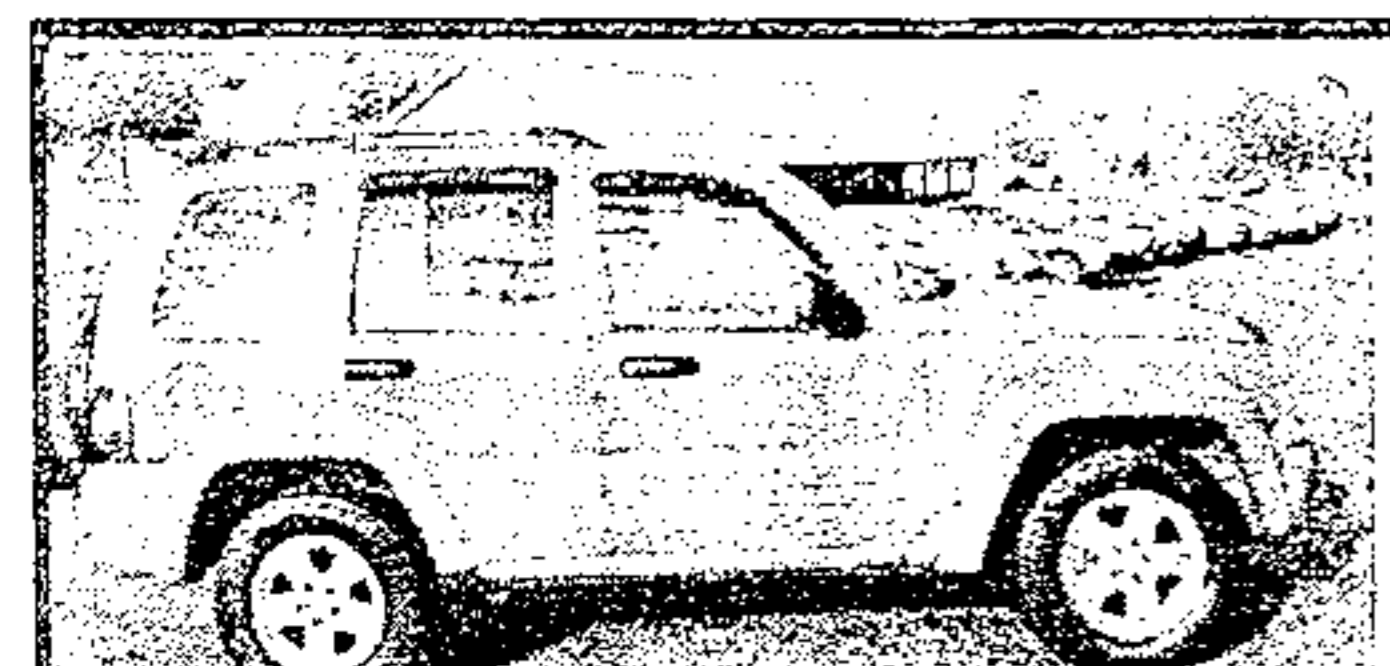

2004 Jeep Liberty, 77k miles,
 Leather, LOADED!!!

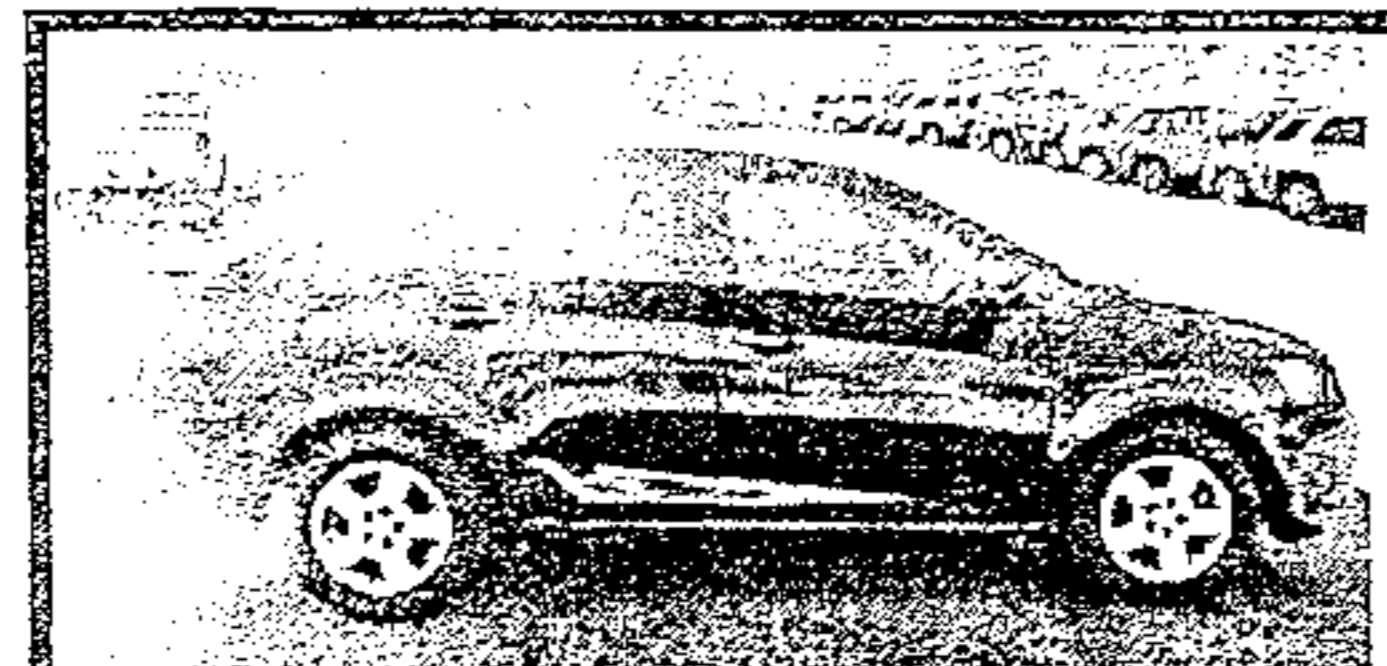

2014 Chevy Sonic, Factory
 Warranty, Low Miles!

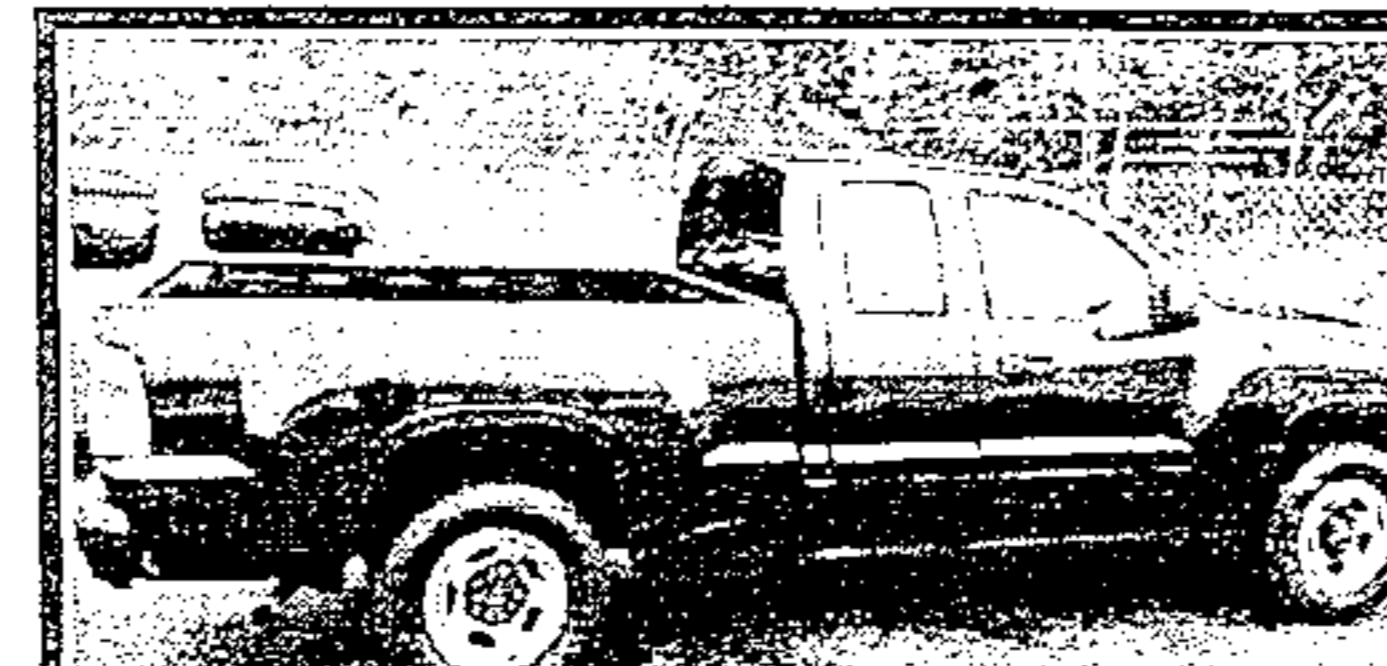

Mitsubishi Raider, Ext. Cab,
 Super Nice Truck

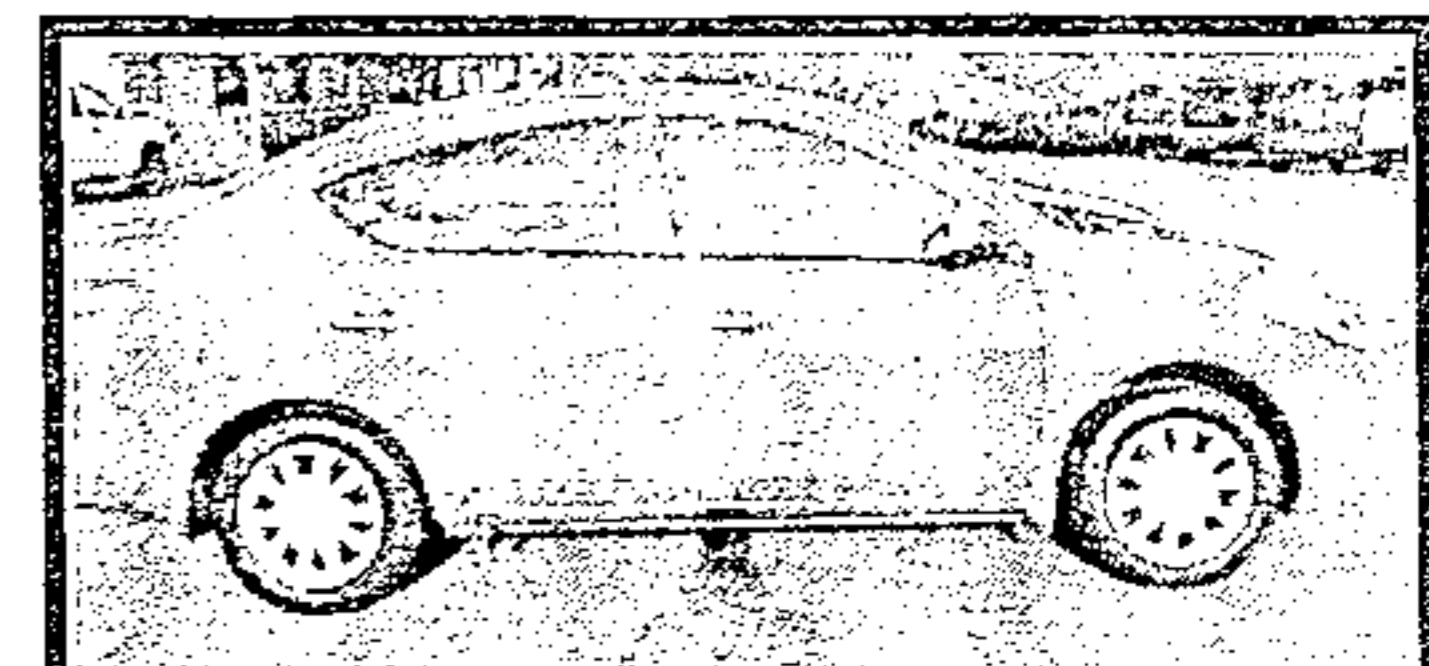

2013 Nissan Versa, Like New!
 LOADED!!!

WALT WILLIAMS, INC.

*with approved credit

3003 Highway 11 Lenoir City, TN **865-986-1111**