

# The Daily Edition

50¢

Serving Loudon, Monroe and Surrounding Counties

Wednesday, February 24, 2016

## Have You Bought From This Guy? If so, it's probably stolen

Loudon Police Detective Sgt. Brian Jenkins is asking for help from anyone who may have bought items from a Loudon man charged with theft and burglary. The man, Jonah Jillson is reported to have been trying to sell stolen items to a witness when he was caught.



(see thief pg. 2) Jonah Jillson

## Couple charged after display at Love's



Douglas Morrissey



Kourtney Morrissey (see couple pg. 5)

## The old gun at the bar trick don't work at Aubrey's



(see gun pg. 7) Michael Russell

## South Carolina native sentenced to 180 months for leadership role in A-PVP trafficking and international money laundering conspiracies

On Feb. 19, 2016, Joshua Lee Lindsey, 30, of Lyman, S.C., was sentenced by the Honorable Pamela L. Reeves, U.S. District Court Judge, to serve 180 months in federal prison for his leadership role in an extensive a-PVP (alpha-pyrrolidinopentiophenone) distribution conspiracy and an international money laundering conspiracy involving northeast Tennessee, southwest Virginia, western North Carolina and western South Carolina.

A-PVP is a synthetic drug pri- (see A-PVP pg. 4)

## Counterfeit Cabs Auto Broker Who Used Salvage Vehicles as Taxis Sentenced

Every day in communities around the nation, the FBI works with its state and local partners to identify and arrest criminals who threaten public safety—including terrorist groups, violent gangs, drug trafficking enterprises, and producers of counterfeit pharmaceuticals, auto parts, and airplane parts.

Most recently, the FBI, in conjunction with the Inspector General for the City of Chicago, conducted an investigation into a fraud scheme that involved the illegal use of salvage vehicles as taxis on city streets—a scheme that potentially put the riding public at risk.

Last month, Chicago auto broker and taxicab operator Alexander Igolnikov

### Verse of the Day

Do everything without complaining or arguing, so that you may become blameless and pure, children of God without fault in a crooked and depraved generation, in

which you shine like stars in the universe. — Philip-  
pians 2:14-15

### Obituaries

see inside  
**Wazzup**

It's warming up already, but the rain makes it super nasty and there have been

lots of flash flooding reported so drive safely.

### Weather

Today: Windy with thunderstorms in the morning. Variable clouds with a chance of lingering showers during the afternoon. A few storms may be severe early. Morning high of 60F with temps

falling to near 45.

Tonight: Windy. Rain showers early, with overcast skies late. Snow mixing in. Low 37F.

Thursday Overcast with rain showers at times. High 44F.  
Thursday Night Partly cloudy skies early will be

(Continued on page 6)

(see FBI pg. 3)



thief

Jonah Jillson, 29, Church Street Loudon, was charged Burglary and Theft of Property. Loudon Police Dept. was dispatched to a theft call. Victim stated that someone had been in his detached garage located behind the residence on Mulberry Street. Several items were taken from the residence. Jonah Jillson ap-

proached a witness and tried to sell one of the stolen items. Jonah was placed in custody . After an investigation was completed Jonah was arrested for the charges. Det. Brian Jenkins LPD, made the arrest.

If you have bought anything from Jonah Jillson please contact Detective Brian Jenkins at 408-0412.

### To Get a Burning Permit:

Loudon (865) 986-8395  
 Monroe (423) 442-7401  
 Roane (865) 354-1054

Call 865-771-2249 to Advertise and start saving today!  
 Has your group got an event coming up?  
 Let us know!!!

Notice: The Daily Edition does not knowingly accept fraudulent or misleading materials. The Daily Edition cannot guarantee the validity of offerings or statements contained herein. All liability for the contents of all advertising, and for any claims that may arise therefrom, is the responsibility of the advertiser or its agency. The Daily Edition reserves the right to reject, edit, or abbreviate any advertisement submitted. Advertising is accepted with the understanding that all liability for all copyright violations is the sole responsibility of the advertiser. Photographs, artwork and other copy submitted for publication is considered the sole property of the advertiser. The Daily Edition will make every effort but will not be liable for failure to publish and ad or for typographical and layout errors. All statements and information about highlights featured items, letters to the editor, herein are those solely given to the interviewer or writer and the Daily Edition assumes no responsibility of the accuracy or validity thereof. The Daily Edition will gladly reprint at no charge that part of an advertisement in which an error occurs provided a claim is made within 3 days of the first publication of the ad. Information contained in the Wazzup is received anonymously and the Daily Edition assumes no responsibility for information and reserves the right to edit or reject any and/or all submissions. The Daily Edition is a daily newspaper of general circulation in Loudon County defined under TCA 2-1-104(a)(13). The Daily Edition also serves Monroe, Knox, Anderson, Roane and Blount counties and serves 30,000 readers weekly. Send mail to PO Box 1240, Lenoir City TN 37771. 865-771-2249. email: dan1204us@yahoo.com  
 The Daily Edition is Loudon County's premier public interest and paid advertising paper. The Daily Edition is produced and published daily Monday through Friday and is circulated throughout Loudon County and parts of Monroe and Knox Counties. Display advertising rates \$5.00 per column inch and quantity discounts available. Call for information on upcoming promotions and events.



# HACIENDA Ayala's

## Mexican Restaurant

Market Dr. \* Lenoir City (In Front of Food City)

**Real Authentic Mexican Food at Affordable Prices**

**BEST**

**MARGARITA**



You've Tried The Rest  
 Now Come Have The Best!!!

We Accept ALL Competitors Coupons **Outside of Mexico City!**

**986-3553**

## Good Credit OK • Bad Credit OK • Bankruptcies OK • Repo OK



2010 Kia Soul Sporty, 4 cyl, Auto, PW, PL, A/C, Great On Gas, Like New



2010 Ford Escape Limited Leather, Alloy Wheels, Heat, A/C, Luggage Rack, 79K,



2007 Dodge Ram 1500 Quad Cab, Thunder Road PKG, 20 in. Wheels, Low Miles, Hemi



2008 Ford Explorer 84k, 3rd Row Seating, Luggage Rack, Tow Pkg, PW, PL



2011 Ford Ranger Low Miles, Tow Pkg, New Tires, A/C, Heat, Bed Liner.



2011 Dodge Grand Caravan DVD, Stow & Go, Loaded, Remote Doors, Rear A/C

# DEPENDABLE MOTORS 986-9343

803 E. Broadway • Lenoir City

Serving Loudon County for 20 Years

\* WAC. See Dealer for details

Visit our website at: [www.dependablemotorslc.com](http://www.dependablemotorslc.com)

FBI was sentenced to a federal prison term after previously pleading guilty to conspiracy to transport, receive, and possess a counterfeit security—in this instance, that “security” was an illegally obtained clean vehicle

title for a salvage car. A vehicle can receive the “salvage” designation—usually from a state motor vehicle agency—for a number of reasons, including having been stolen, vandalized, in an accident, in a flood or other natural disaster, etc. And once a salvage title is issued, there’s often no legal mechanism to obtain a “clean” title for the same vehicle.

But there are illegal mechanisms, and that’s just what Igolnikov and several associates used to get rid of the salvage designation.

In his plea agreement, Igolnikov admitted to running a scheme from 2007 through April 2010 that involved buying significantly damaged vehicles with salvage titles from online auction sites. He purchased the vehicles in the name of the business he owned—Seven

Amigos Used Cars—and had the vehicles towed to the Chicago address that housed Seven Amigos and a company called Chicago Carriage Taxi. Once there, the cars were repaired.

In the meantime, several of Igolnikov’s associates worked on taking care of the salvage designations on the purchased vehicles by submitting fraudulent paperwork to the nearby Indiana Bureau of Motor Vehicles in an effort to obtain “re-

built” titles. Under Indiana law, a vehicle that had been issued a salvage title could be repaired and issued a title with a rebuilt designation if the vehicle was examined by a law enforcement officer who certified that the vehicle had been repaired properly. Igolnikov’s associates submitted paperwork purportedly certifying that an officer had examined their vehicles and that the repairs conformed

(see FBI ctd. pg. 5)

**For Sale: oak Wood Mulch**

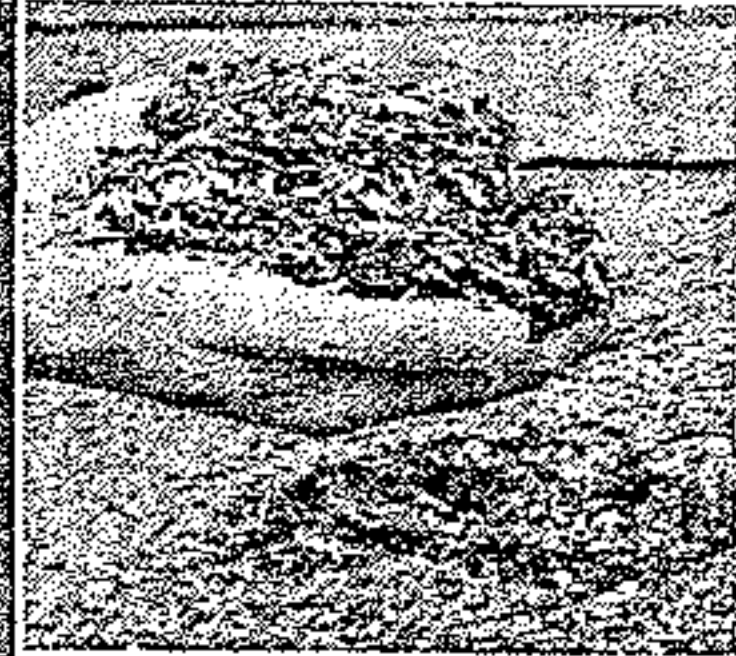

Mushroom Compost Topsoil.

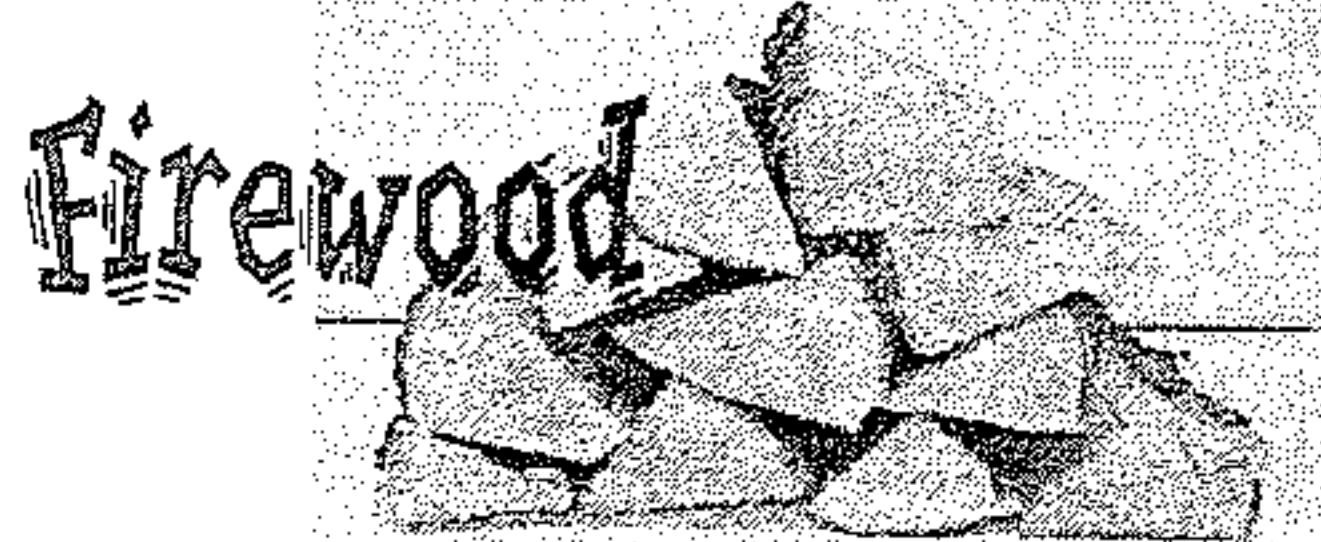

Call Steve Spoon 986-4282

**STAINED INK**

**TATTOO & PIERCING**  
LENOIR CITY 865 816-6440  
NEW OWNER • NEW ARTIST • SINCE 2011  
521 Hwy 321 next to Vape & Stuff & Inn Of Lenoir!  
Clean-Affordable-Quality-Custom  
Tattoo's You've Always Wanted!

BRING IN THIS AD FOR **\$25 OFF**  
NEW INK FOR NEW CUSTOMERS ONLY!

Check us out on FB.com/  
Stained.Ink.Tattoo/  
www.STAINEDINK.com



**BIMBO'S**  
Deli Open 24 Hours  
865-986-9643 Call Ins Welcome

**Specials**

Lg. Cold Sub, bag of chips and 16 oz. fountain drink only \$6.29

Footlong Corn Dog \$2.59

**West End Storage & Warehouses**  
502 Ward Avenue • Loudon  
Call 865-458-4774 or 865-679-5555



**C&J Towing and Recovery**

**LOWEST TOWING RATES AROUND!!!**

Have you been overcharged for any type of towing service in the Lenoir City area? If you have a breakdown or accident please OWNER REQUEST C&J Towing with the officer. Also please call your Sheriff and ask him to place C&J Towing on the “Rotation List\*” and help other motorists save as much as you did! We at C&J are locally owned and operated, State approved, licensed, bonded and insured. Call and let us know if your denied service or how we can be of assistance.

\*note: the “Rotation List” is a list of wrecker services that provide service for wrecks, DUI’s, breakdowns, etc. and are on an on-call basis for service. This list is approved by the Sheriff.

Cliff Teeters • Owner  
865-809-1661

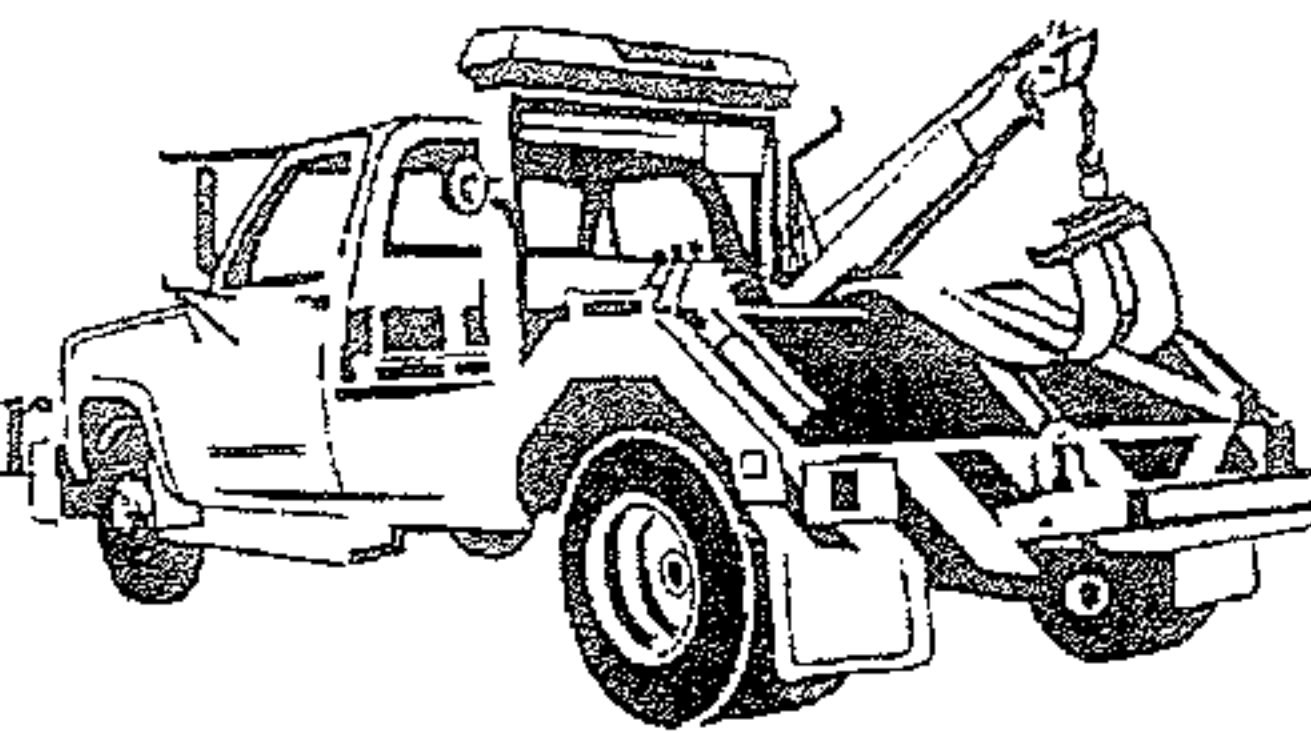

**A-PVP**

marily ordered from China, which is commonly referred to on the street as "gravel" or "flakka." Common effects on users include: extreme paranoia; hallucinations; elevated blood pressure; extremely high body temperature; excited deliri-

um; staying awake for days; hostility and having exceptional strength without apparent fatigue. These characteristics make the drug not only very dangerous for the user but also for law enforcement responding to people who are high on it. A-PVP has been referred to by users of the substance as "meth

on steroids."

According to his plea agreement on file with U.S. District Court, Lindsey admitted that between January 2012 and October 2014 he conspired to distribute and was accountable for a conservative estimate of between 35,000 and 75,000 grams (35 to 75 kilograms) of a-PVP. Lindsey and Randall Scott Braddock, 50, of Hendersonville, N.C., became involved in obtaining a-PVP from China and redistributing it for profit as early as January 2012. Braddock was also charged in this case and was previously sentenced to serve 192 months in federal prison.

The investigation in

this case resulted in the recovery of a large number of emails between Lindsey and a particular a-PVP supplier in China. In these emails, Lindsey asked for the "most potent" and "top quality" a-PVP they had available. He asked for the "big rocks," because "demand was high" and was concerned because there had been complaints about a recent drop in potency. Lindsey asked that the supplier in China label the a-PVP as acrylic paint and made up a fake name of 'AcryliCO' for the company to ship to him to avoid detection from law enforcement. He requested the supplier send the a-PVP to his address in

South Carolina, instead of North Carolina or Tennessee because his partner Braddock had a previous arrest in North Carolina for dealing in a-PVP and other substances. In an email to the supplier Lindsey wrote, "I already gave u good business in n.c. and Landrum s.c, All that was brought to you by me! Scott Braddock and Rick lowe! The whole nc tn boom last year! You're welcome!" Lindsey expressed his gratification to the China a-PVP supplier by emailing, "You have been a blessing for me! My life is much better now!"

Lindsey later recruited and hired other

(see A-PVP ctd. pg. 5)

**Public Notice**  
**The Loudon County**  
**Corrections Partnership**  
**Committee will meet March**  
**2nd, 2016 at 12:00 at the**  
**Justice Center to discuss**  
**future plans.**

**APPLY FOR AN EASY ADVANCE**  
**AND GET MONEY FAST!**

**\$750 Easy Advance**  
**at Liberty Tax**  
**at No Additional Cost!**



**820 Hwy 321 N**      **119 E. Broadway Street**  
**Across from Burger King**      **Downtown Hwy 11**

**Lenoir City, TN 37771**  
**865-986-8335**

An Easy Advance (EA) is a \$750 loan secured by your tax refund and is offered by Republic Bank & Trust Company, member FDIC, to qualifying applicants. There are no fees or interest associated with the EA. Subject to approval. Visit your Liberty office to learn more. Officer Expires 2-28-15.

**BUDGET**  
*Transmissions*



**302 S. Northshore Drive Knoxville**  
**(865) 584-4391** *budget-transmissions.com*

**Why Buy From Budget?**  
**Free Towing From Lenoir City**  
**or Loudon County**  
**20 Years of BBB Zero Customer**  
**Complaints Award Member**  
**A+ Plus Rated**  
**Huge Transmission Inventory**  
**Best Technicians Period!!!**  
**Call (865) 584-4391 Today!**





good to know you™

**IMMEDIATE OPENINGS!**

Randstad is NOW HIRING for 2nd shift Assembly Positions at Commercial Vehicle Group. These are long-term, temp-to-hire positions!

Hours: 4:30pm - 3:30am (end times vary)  
 Pay: \$10/\$10.50 per hour

You may apply by visiting our Facebook page [www.facebook.com/vonorejob](http://www.facebook.com/vonorejob) and clicking the "Sign Up" button. You can also get a paper application from the Guard Shack at 200 National Drive, Vonore, TN 37885.

For questions, call 423.884.4733  
[www.randstadstaffing.com](http://www.randstadstaffing.com)

EOE



Staffing | Professionals | Search & Placement | HR Solutions | Inhouse Services

couple

Kourtney Morrissey, 28, Lovenia Ave Knoxville, was charged with Public Intoxication, and Disorderly Conduct.

Douglas Morrissey, 30, Lovenia Ave Knoxville, was charged with Criminal Impersonation, Public Intoxication, and Disorderly Conduct.

Officer Tyrel Lorenz LCPD, was dispatched

to Loves Truck Stop for a couple involved in a argument inside the store. Upon arrival Officer made contact with both subjects in an argument inside the store, Officer observed their behavior was causing a disturbance and keeping people from caring out there lawful activities inside the store. Officer made contact and identified the subjects as Kourtney and Douglas Mor-

rissey, who appeared to be intoxicated. Douglas stated he was arguing because Kourtney had punched him in the mouth. Both parties were not cooperative in telling what happened. A witness told Officer she observed Douglas choking Kourtney inside the store.

Both were placed under arrest.

Officer Tyrel Lorenz LCPD, made the arrest.

A-PVP ctd. from pg. 4

individuals from South Carolina to assist in the conspiracy by providing them money to send to the supplier in China via Western Union. After the 500 to 1,000 gram shipments of a-PVP were received in South Carolina, Lindsey instructed the others to repackage it into 50 gram bags and deliver them to Braddock in Hendersonville, N.C., for distribution to a very

large number of other dealers and customers, primarily in northeast Tennessee.

Others who were charged and previously sentenced in this conspiracy include Richard McNeal Hillman, Ronnie Lee Shelton, Austin Michael Stallard, Johnny Michael Stallard, Desera Jade Allen, Phillip Wayne Mullins, Johnny White, Michael Ray Mangum, Eric Matthew Vance, Evelyn Vickers, James Elmer McClain, Joshua Brandon Hinkle and Richard Allen Lowe, who were sentenced to serve 188 months, 235 months, 121 months, 180 months, 151 months, 151 months, 120 months, 120 months, 135 months, 110 months, 110 months and 80 months in federal prison respectively.

Law enforcement agencies participating in the investigation included the Drug Enforcement Administration, Bureau of Alcohol, Tobacco, Firearms and Explosives, Homeland Security Investigations, Sullivan County Sheriff's Office, Kingsport Police Department, Hawkins County Sheriff's Department, Johnson City Police Department, Greeneville, Tennessee Police Department, Hendersonville, North Carolina Police Department, and Scott County, Virginia Sheriff's Office. Assistant U.S. Attorney Wayne Taylor represented the United States.

This case was a result of the Department of Justice's Organized Crime and Drug Enforcement Task Force (OCDEF) program, the centerpiece of the Department of Justice's

(see A-PVP conc. pg. 8)

# PURDY'S AUTO PARTS AND SALVAGE

WE BUY SCRAP IRON • COPPER • BRASS • ALUMINUM

\$

Paying Top \$\$\$

Call For Latest Prices

You Name It, We Buy It!

Radiators, Wheels, Batteries, Appliances, Farm Equipment

**Copper**

Paying Top \$\$\$

Call For Latest Prices

You Call We Haul!

423-519-5402



Prices subject to change with the market.

423 337-3977

149 County Road 323 Sweetwater

**Complete Cars**  
per 100 lbs.

**Scrap Metal**

Paying Top \$\$\$

Call For Latest Prices

per 100 lb

**We Buy Batteries**

**Aluminum Cans**

Paying Top \$\$\$

Call For Latest Prices

**Now Selling  
Aftermarket  
Body Parts at  
Discount Prices**

Prices subject to change with the market.

gun

Michael Russell, 51, Wingate Drive Clarksville, was charged with Possession of a Handgun While Under the Influence, and Public Intoxication. Officer Tyrel Lorenz LCPD, was dispatched to Aubrey's for an intoxicated person with a possible firearm inside the bar. Upon arrival Officer came in contact with the suspect identified as Michael Russell. Upon speaking with Michael Officer could smell a strong odor of alcohol coming from his person. Officer ask Michael if he had a firearm in his possession, he stated

he didn't know. Officer ask again and Michael stated he did. Officer recovered a loaded Kahr PM-40 semi automatic pistol in Michael right front pocket. Michael was unable to maintain his balance and had slurred speech. Michael was placed under arrest. Officer Tyrel Lorenz LCPD, made the arrest.

Ads starting at only \$1 per day.  
Call 865-771-2249

**Help Wanted**  
Position Available Immediately! Apply in person at the Kenjo Marathon on Hwy 321 in Lenoir City.

FBI etd. from pg. 3

to Indiana law, but in reality, no officer ever examined their vehicles.

For Igolnikov's scheme to work, though, the rebuilt title was not good enough. Chicago's city rules would not allow a vehicle with either a salvage or rebuilt title to be approved as a taxicab. So he and his associates took it one step further: They placed a sticker, usually one purporting to be from an online auction, over the "rebuilt" section of the Indiana title to conceal the fact that the title had a rebuilt certification. They then used that title to obtain a clean title from the Illinois Secre-

tary of State's Office. Armed with the clean title, Igolnikov could apply for a license to operate the vehicle as a taxicab in Chicago. And for approximately three years, he and his associates operated approximately 112 salvage—and potentially unsafe—taxis on Chicago streets.

But the scheme was ultimately uncovered, and as a result of the close working relationship between the FBI's Chicago Field Office, Chicago's Inspector General, and the U.S. Attorney's Office for the Northern District of Illinois, the individual responsible was identified and brought to justice.

**LONNIE JONES OPTICAL DISPENSARY**  
"We Make The Difference You Can See"  
Locally Owned and Operated

Over 1000 Frames To Choose From  
No Frame Over \$69.00



On the corner of A & Depot Street, Lenoir City  
**986-7803**  
Serving Loudon County for over 40 years

**LOOK! \$75 Weekly Payments LOOK!**

MARTY'S AUTO SALES • 986-2222 • MARTY'S AUTO SALES • 986-2222 • MARTY'S AUTO SALES • 986-2222 • MARTY'S AUTO SALES • 986-2222 • MARTY'S AUTO SALES • 986-2222

**Bad Credit**  
**Divorce**  
**Fixed Income**  
**Repos**  
**Bankruptcy**  
**No Credit**

 **APPROVED!** **NO CREDIT CHECKS**

Visit Us On The Web At:  
**martysautosales.net**

 <p>\$499 down*</p> <p>07 Cobalt, 5spd, gas saver, runs great Only \$499 down*</p>	 <p>\$299 down*</p> <p>99 Solara, V6, auto, sporty, Only \$299 down*</p>	 <p>\$599 down*</p> <p>04 Santa Fe, auto, Nice, clean. Only \$599 down*</p>	 <p>\$499 down*</p> <p>01 Sebring 2dr. sporty, Only \$499 down*</p>
 <p>\$599 down*</p> <p>05 Trailblazer, auto, good miles Only \$599 down*</p>	 <p>\$499 down*</p> <p>04 Aveo, auto, gas saver, Only \$499 down*</p>	 <p>\$799 down*</p> <p>06 Tiburon GT, 5 speed, sporty, Only \$799 down*</p>	 <p>\$99 down*</p> <p>98 Bonneville, 6 cyl, Auto, low payments only \$99 down*</p>

**NO Credit Checks** *Marty's Auto Sales* **986-2222** **100% Approval\*** *Se Habla Espanol*

\*See Dealer for details. All down payments plus tax, tag, title and fees.

MARTY'S AUTO SALES • 986-2222 • MARTY'S AUTO SALES • 986-2222 • MARTY'S AUTO SALES • 986-2222 • MARTY'S AUTO SALES • 986-2222 • MARTY'S AUTO SALES • 986-2222

A-PVP conc. from pg. 5 drug supply reduction strategy. OCDEF was established in 1982 to conduct comprehensive, multi-level attacks on major drug trafficking and money laundering organizations. Today, OCDEF combines the resources and expertise of its member federal

agencies in cooperation with state and local law enforcement. The principal mission of the OCDEF program is to identify, disrupt, and dismantle the most serious drug trafficking and money laundering organizations and those primarily responsible for the nation's drug supply.

## THE RELIC SHOP

521 Hwy 321 Lenoir City Suite 3  
next to Stained Inc and the Inn of Lenoir  
**865-250-9280**

WE ARE IN TUCSON, ARIZONA BUYING UP FOSSILS FOR THE SHOP. WE NEED TO MAKE ROOM!!!

ALL AMETHYST 40% OFF

GREAT SELECTION OF ANCIENT MEGALODON SHARK TOOTH OVER 8 MILLION YEARS OLD

### Is Your Washer Broken?

Call Me

! Only Charge \$100 Period!!!

Call Allen

865-617-7113

## A Name You Already Know And Trust Just Got Even More Dependable

### DEPENDABLE AUTO SERVICE, LUBE AND TIRES

## is Now Offering

### Expert, Affordable Transmission Service

All ASE Certified Technicians

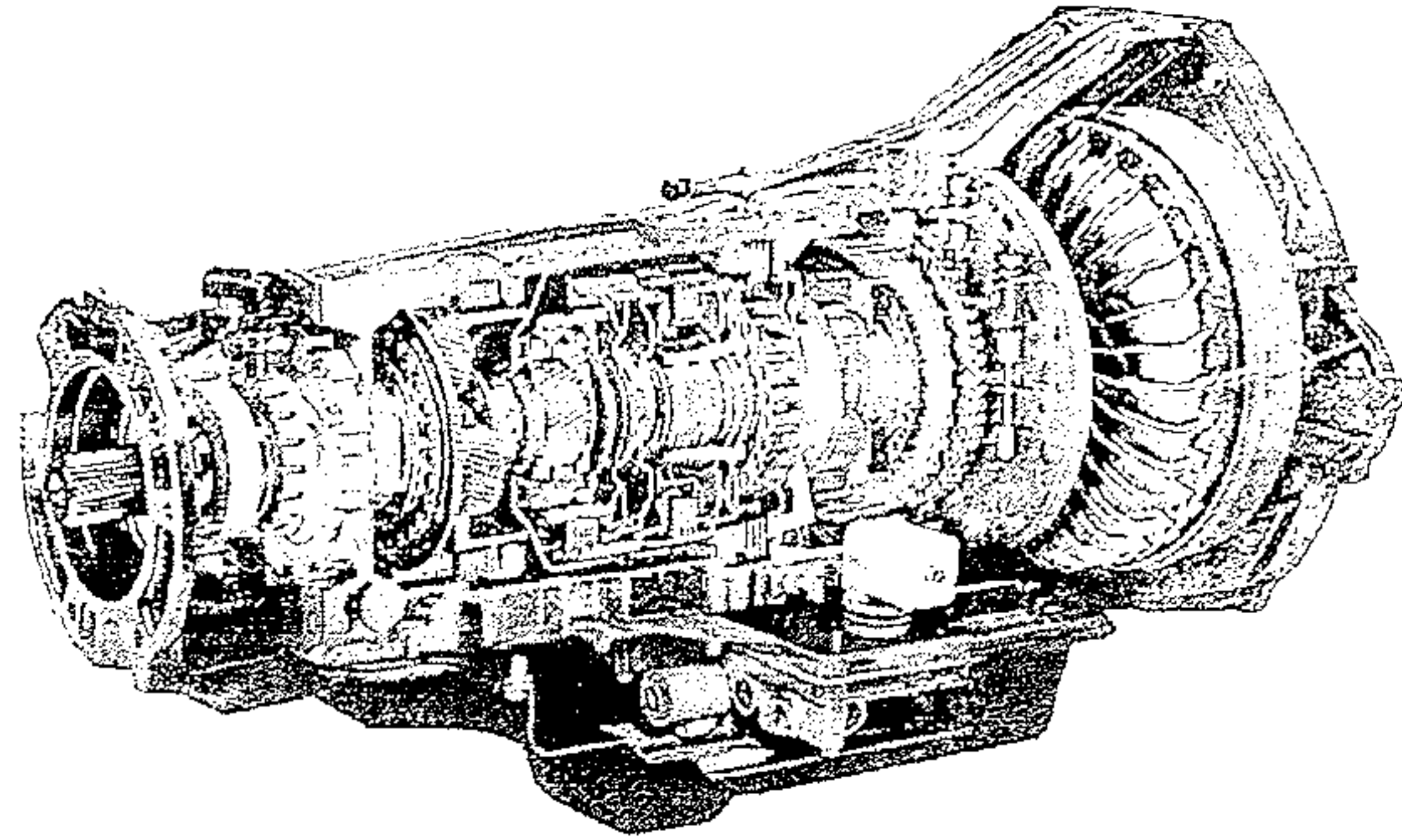

We proudly welcome all New Customers and Former Advanced Transmission Customers with a 10% Discount and Any Transmission Service or Repair\*

865-986-9359

865-986-5050

## Bad Credit, No Credit OK!!! We Finance Everybody!!!

Taxes Done Here!!! Bring your last pay stub or W2 and DRIVE TODAY!!!

Over 100 Cars, Trucks & Vans in Stock - Warranties On ALL Vehicles Sold!!!

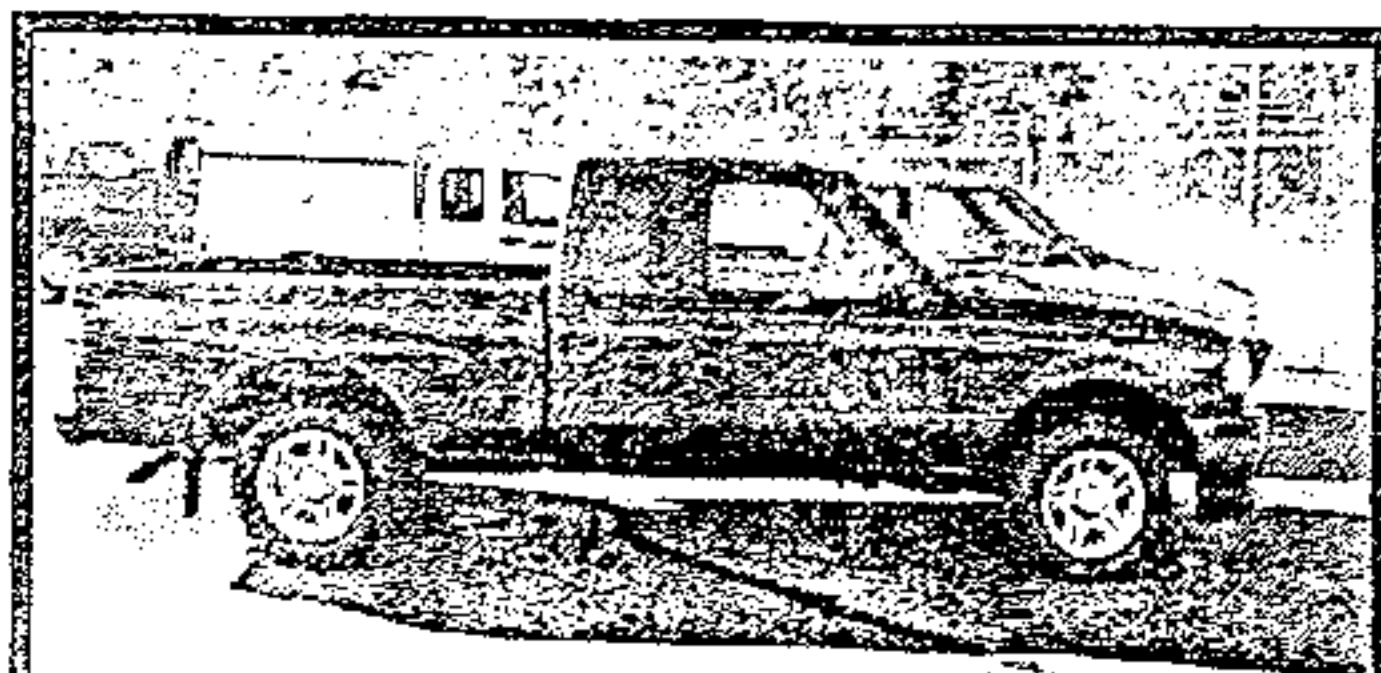

2005 Ford Ranger, Super Nice Truck, Very Low Miles

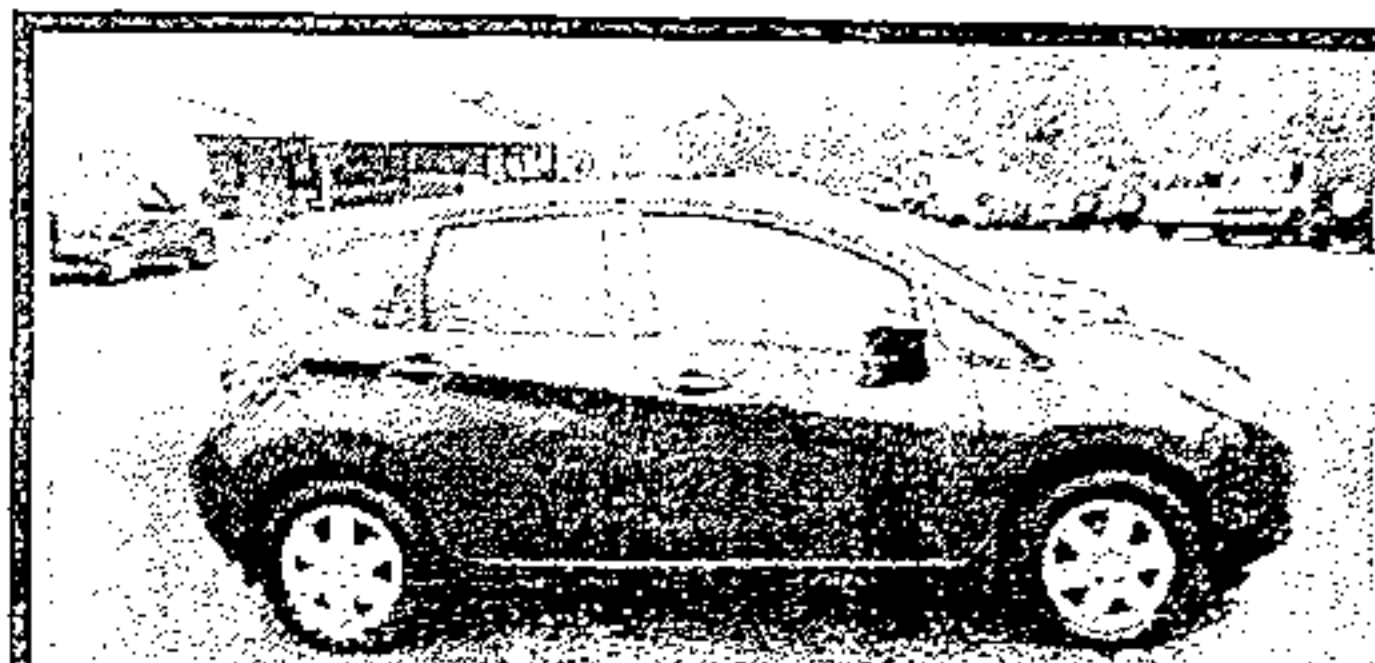

2015 Nissan Versa Note, Factory Warranty, Low Miles

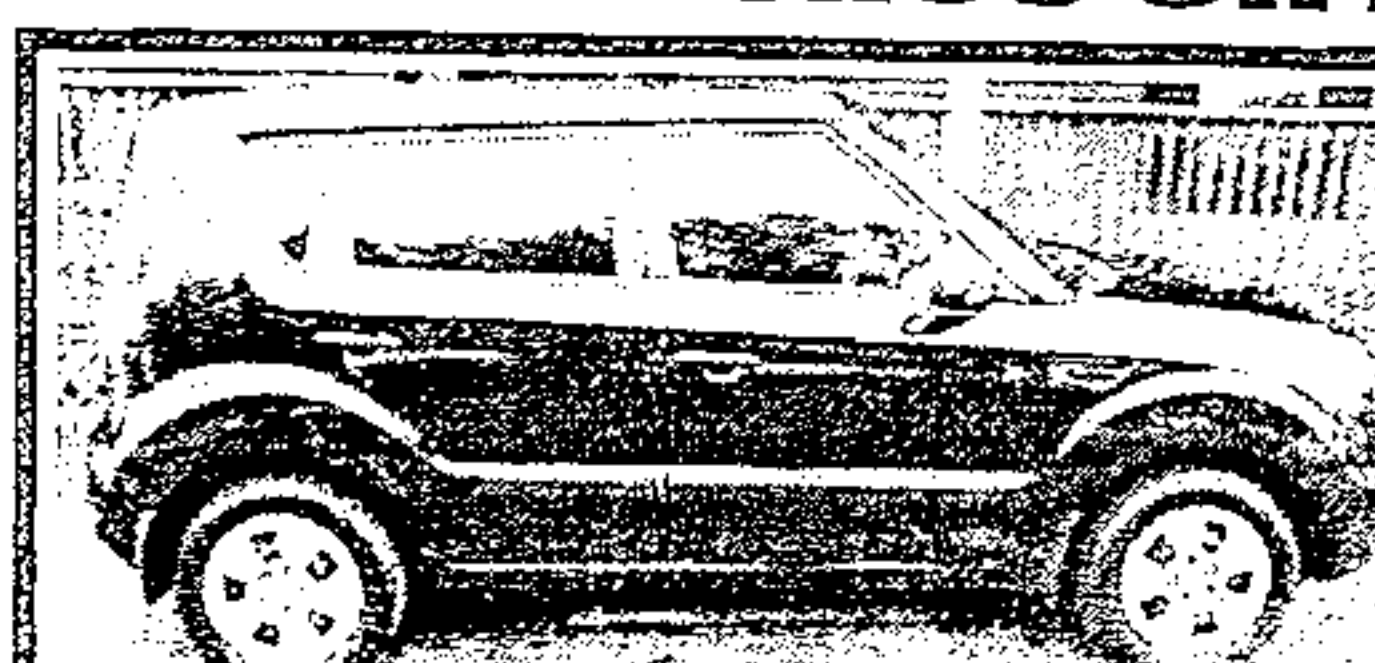

2011 Kia Soul, 5 speed, 4 dr, Gas Saver, Nice & Clean

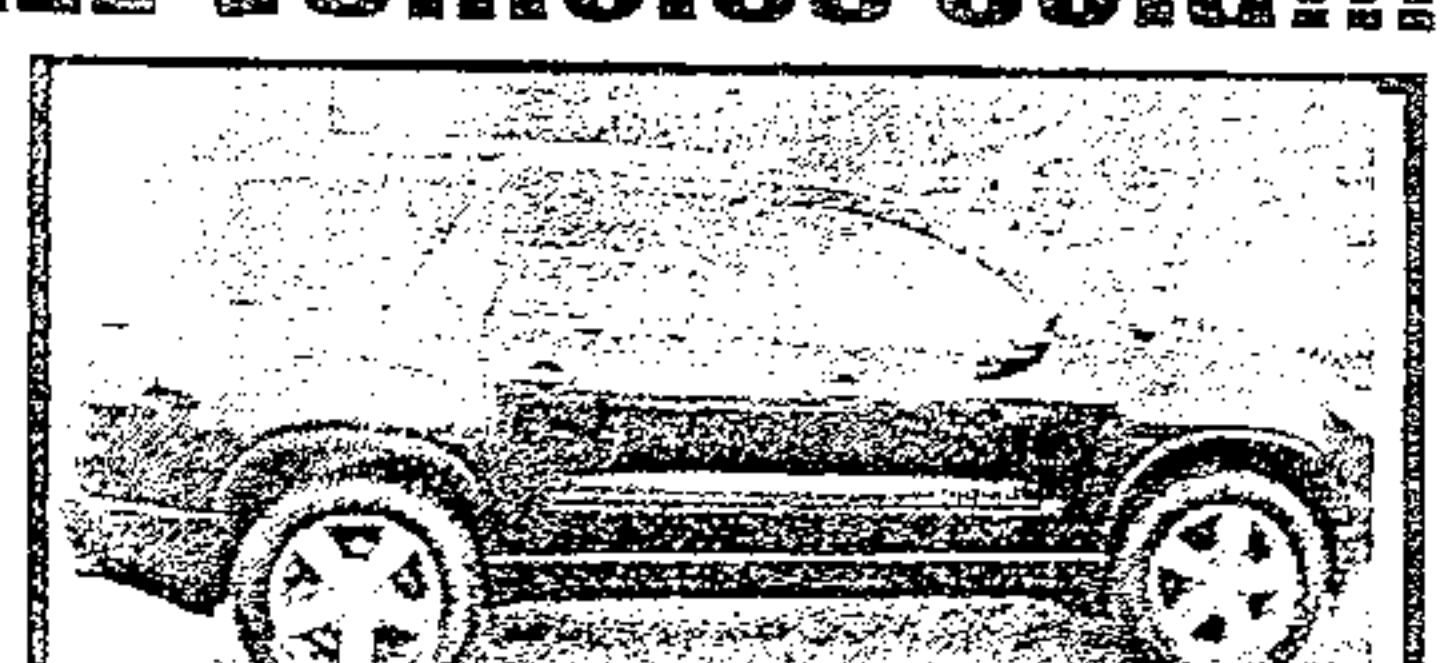

2010 GMC Acadia, LOADED!!! Sunroof

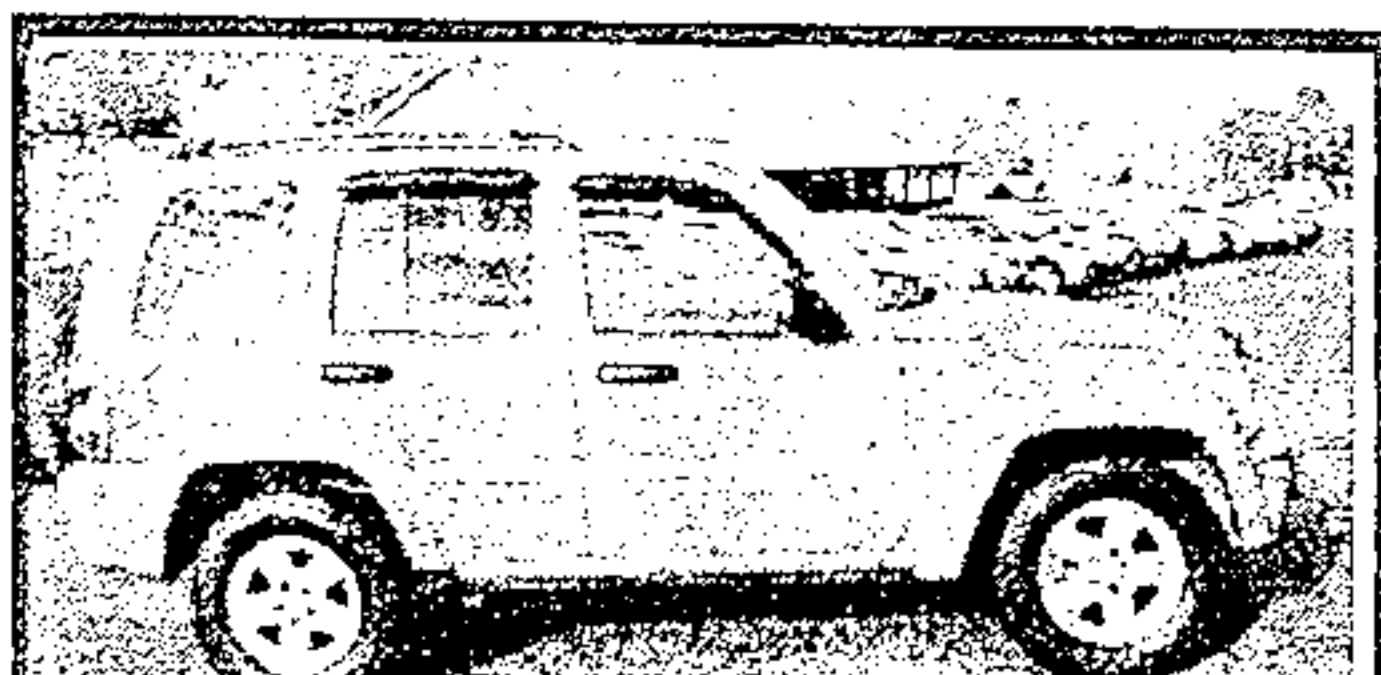

2004 Jeep Liberty, 77k miles, Leather, LOADED!!!

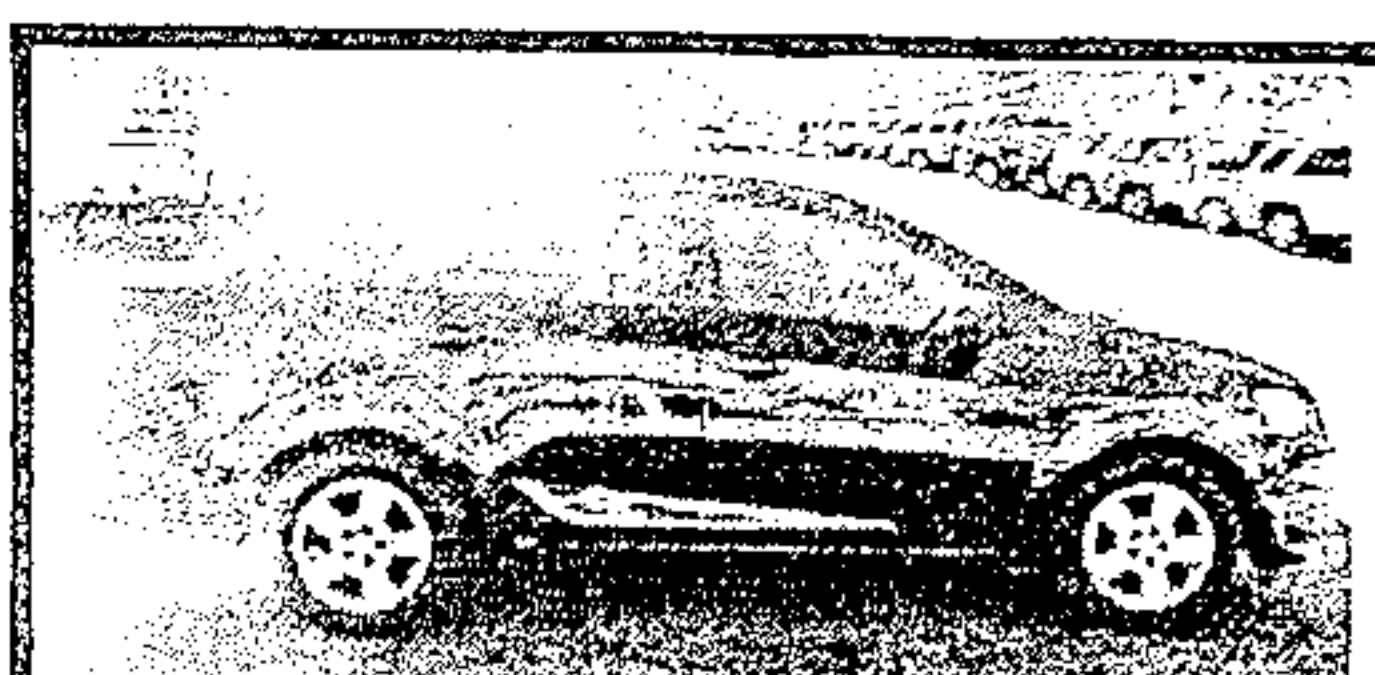

2014 Chevy Sonic, Factory Warranty, Low Miles!

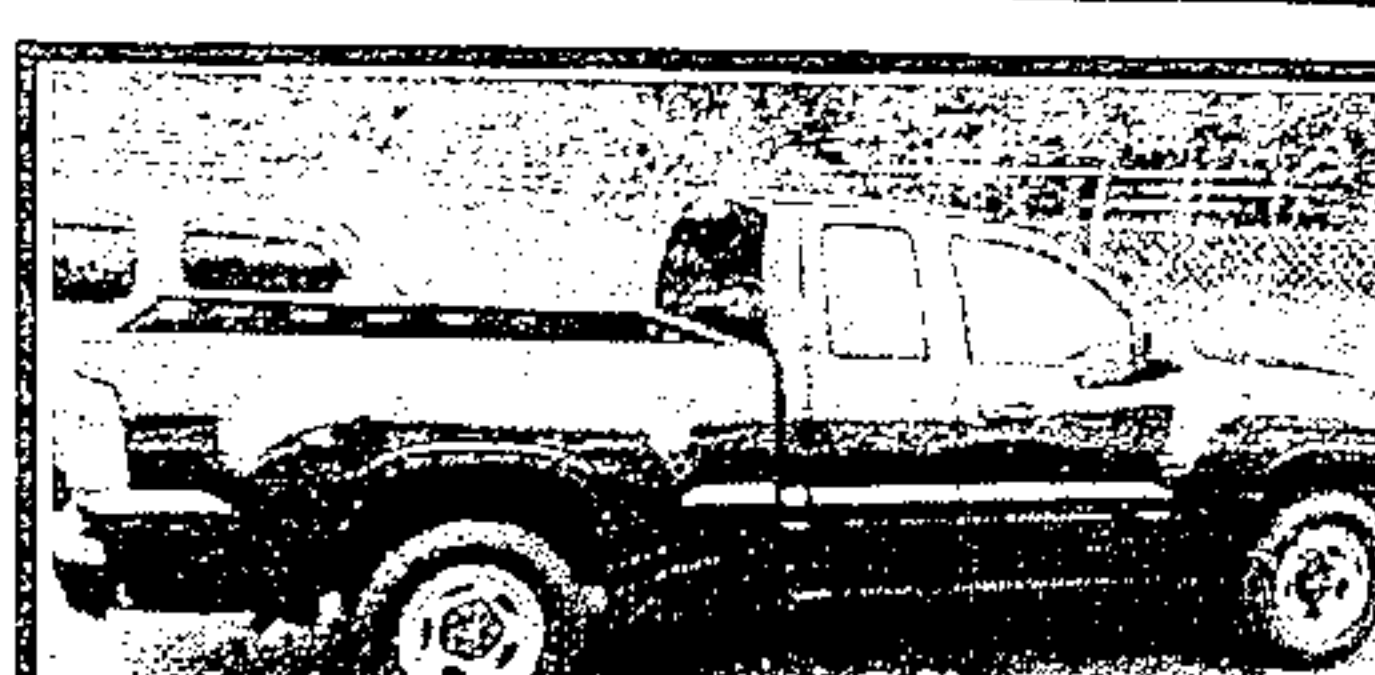

Mitsubishi Raider, Ext. Cab, Super Nice Truck

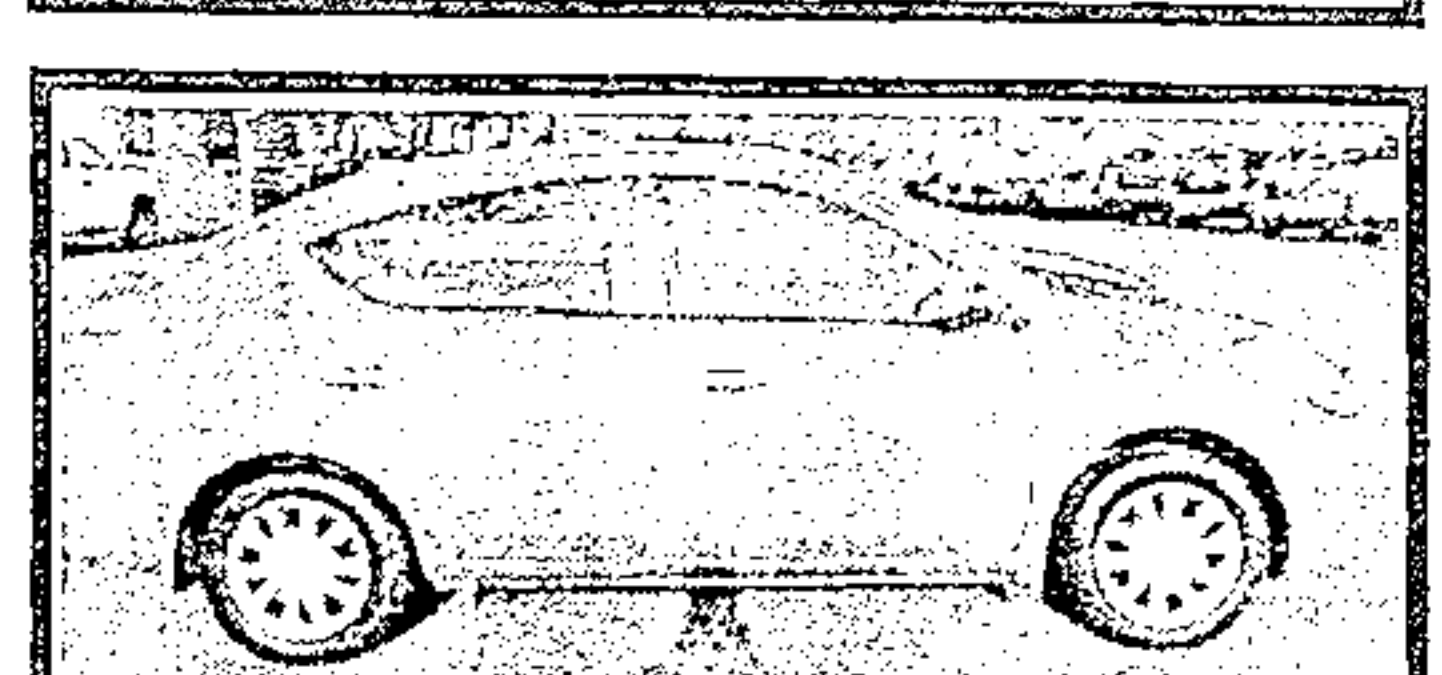

2013 Nissan Versa, Like New!, LOADED!!!

# WALT WILLIAMS, INC.

\*with approved credit

3003 Highway 11

Lenoir City, TN

**865-986-1111**