

The Daily Edition

50¢

Serving Loudon, Monroe and Surrounding Counties

Thursday, February 11, 2016

Stolen truck wrecked; man charged with theft

Jeremy Allen Coleman, 25, Winchester Street, Rockwood, was charged with theft of property.

According to the report, On February 6, 2016, the defendant, Jeremy Allen Coleman did take property valued at \$7,500 from the victim. Furthermore, Coleman took said property without vic-

(see theft pg. 2)



Jeremy Coleman

Governor Haslam, Commissioner Boyd Announce The Jack Daniel Distillery to Expand in Lynchburg

Global demand drives \$140 million investment

Tennessee Gov. Bill Haslam and Department of Economic and Community Development Commissioner Randy Boyd along with Brown-Forman Corporation officials announced today expansion plans for the Jack Daniel Distillery.

The \$140 million investment will be used to construct two new barrel-houses as well as modify and expand the existing

bottling facility to provide additional bottling and shipping capacity to meet future demand. As a result, 30 new jobs will be created in Moore County.

"Jack Daniel's is a Tennessee tradition that was born in one of Tennessee's smallest counties and has grown into a globally recognized brand. That says a lot about the quality and commitment of Moore County's workforce," Haslam said. "I thank Brown-Forman and

(see JD pg. 5)

Man charged after not letting victim leave



(see assault pg. 7) Jorge Abrego

Haslam: State of Our State Is One of Unique Opportunity

Budget proposal makes the largest K-12 investment without a tax increase in state history

Tennessee Gov. Bill Haslam delivered his 2016 State of the State and Budget Address before a joint session of the 109th General Assembly, unveiling a balanced \$34.8 billion proposal that makes the largest in-

vestment in K-12 education without a tax increase in Tennessee's history.

The governor's Fiscal Year 2016-2017 budget proposes 261 million in new dollars for Tennessee public education, including \$104.6 million for teacher salaries.

In his speech Haslam highlighted the collaborative effort across state

government to grow Tennessee's economy, reduce ongoing costs, provide high quality service to taxpayers and maintain fiscal discipline that has positioned Tennessee to invest in its priorities.

"The reality is that the state of our state is one of unique opportunity, an opportunity that must not go to waste," Haslam said. "This opportunity is a result of a strengthening economy combined with the hard work and discipline of our departments and the conservative fiscal strategy employed by the General Assembly," (see haslam pg. 4)

Soddy Daisy man sentenced to 7 years in federal prison for child pornography

Jason Collins, 37, of Soddy Daisy, Tenn., was sentenced by the Honor-

able Harry S. Mattice, U.S. District Judge, to

(see sentenced pg. 3)

Verse of the Day

Do nothing out of selfish ambition or vain conceit, but in humility consider others better than yourselves. — Philippians 2:3

Obituaries

see inside

Wazzup

Hope Everyone Is Ready, Winter Is Officially Upon Us!!!

Weather

Today: Sunshine and clouds mixed. High 43F.

Tonight: Partly cloudy during the evening followed

by cloudy skies overnight.

Low around 25F.

Friday Cloudy skies early, followed by partial clearing. High 48F.

Friday Night Partly to mostly cloudy. A few flurries or snow showers possible. Low 24F.

Horoscopes

Aquarius 1/20-2/19

Your feelings are so raw now that you don't know how to say what you're thinking without upsetting others. However, maintaining silence isn't a smart strategy either, since suppressed (Continued on page 6)



theft

tims knowledge or consent, and with the intent to deprive victim of ownership. Victim vehicle, a 1994 Ford F250 4x4 truck, was parked in front of his residence at W 6th Ave., Lenoir City. Coleman entered victim truck and forced apart the steering column cover, then started the truck using a screwdriver. Coleman then

drove away in victim truck. At 1:06 PM, same date, hikers discovered victim truck, stuck in a remote wooded area near the lake off Jackson Bend Road and subsequently reported the discovery to the Loudon County Sheriff's Office. When deputies arrived at the scene, Coleman was still in the driver's seat of the truck and was trying drive away. However, the truck

remained stuck in mud, and Deputies removed Jeremy from the driver's seat and placed him in custody. Coleman had driven victim truck approximately 1/4 mile off road down a narrow trail, before getting it stuck on an em-

bankment. There was significant damage done to victim truck and recovery would require use of heavy equipment. Coleman was transported to the Loudon County Jail by Corp. Pete McGinley LCSO.

Notice: The Daily Edition does not knowingly accept fraudulent or misleading materials. The Daily Edition cannot guarantee the validity of offerings or statements contained herein. All liability for the contents of all advertising, and for any claims that may arise therefrom, is the responsibility of the advertiser or its agency. The Daily Edition reserves the right to reject, edit, or abbreviate any advertisement submitted. Advertising is accepted with the understanding that all liability for all copyright violations is the sole responsibility of the advertiser. Photographs, artwork and other copy submitted for publication is considered the sole property of the advertiser. The Daily Edition will make every effort but will not be liable for failure to publish and ad or for typographical and layout errors. All statements and information about highlights featured items, letters to the editor, herein are those solely given to the interviewer or writer and the Daily Edition assumes no responsibility of the accuracy or validity thereof. The Daily Edition will gladly reprint at no charge that part of an advertisement in which an error occurs provided a claim is made within 3 days of the first publication of the ad. Information contained in the Wazzup is received anonymously and the Daily Edition assumes no responsibility for information and reserves the right to edit or reject any and/or all submissions. The Daily Edition is a daily newspaper of general circulation in Loudon County defined under TCA 2-1-104(a)(13). The Daily Edition also serves Monroe, Knox, Anderson, Roane and Blount counties and serves 30,000 readers weekly. Send mail to PO Box 1240, Lenoir City TN 37771. 865-771-2249. email: dan1204us@yahoo.com

The Daily Edition is Loudon County's premier public interest and paid advertising paper. The Daily Edition is produced and published daily Monday through Friday and is circulated throughout Loudon County and parts of Monroe and Knox Counties. Display advertising rates \$5.00 per column inch and quantity discounts available. Call for information on upcoming promotions and events.



HACIENDA Ayala's

Mexican Restaurant

Market Dr. * Lenoir City (In Front of Food City)

Real Authentic Mexican Food at Affordable Prices

BEST MARGARITA









You've Tried The Rest Now Come Have The Best!!!

We Accept ALL Competitors Coupons Outside of Mexico City!

986-3553

Good Credit OK • Bad Credit OK • Bankruptcies OK • Repo OK

| | | |
|--|--|---|
|  <p>2010 Kia Soul Sporty, 4 cyl, Auto, PW, PL, A/C, Great On Gas, Like New</p> |  <p>2010 Ford Escape Limited Leather, Alloy Wheels, Heat, A/C, Luggage Rack, 79K,</p> |  <p>2007 Dodge Ram 1500 Quad Cab, Thunder Road PKG, 20 in. Wheels, Low Miles, Hermi</p> |
|  <p>2008 Ford Explorer 84k, 3rd Row Seating, Luggage Rack, Tow Pkg, PW, PL</p> |  <p>2011 Ford Ranger Low Miles, Tow Pkg, New Tires, A/C, Heat, Bed Liner.</p> |  <p>2011 Dodge Grand Caravan DVD, Stow & Go, Loaded, Remote Doors, Rear A/C</p> |

DEPENDABLE MOTORS 986-9343

803 E. Broadway • Lenoir City

* WAC. See Dealer for details Visit our website at: www.dependablemotorslc.com

Serving Loudon County for 20 Years

sentenced to serve 85 months in prison, followed by a 15-year term of supervised release. Collins pleaded guilty in August 2015, to receipt of child pornography. Restitution was also ordered to some of his victims.

The indictment and subsequent conviction of Collins was the result of a year-long investigation conducted by the Federal Bureau of Investigation (FBI), Bradley County Sheriff's Department, and Harriman Police Department. The investigation began when a Harriman Police detective was able to download images and videos from a Peer-to-Peer internet account belonging to Collins on three different dates over the course of three months. These images and videos were of minors engaging in sexual activity. The FBI, along with an Internet Crimes Against Children Task Force Officer from the Bradley County Sheriff's Department, discovered that Collins had more than 80,000 images and 300 videos on his computer and other electronic storage media. The images and vid-

eos were compared with those from known victims through the National Center for Missing and Exploited Children's (NCMEC) database. The NCMEC database found that the images belonged to 222 known victim series and the videos belonged to 90 known victim series.

This case was brought as part of Project Safe Childhood, a nationwide initiative to combat the growing epidemic of child sexual exploitation and abuse launched

in May 2006 by the Department of Justice. Led by U.S. Attorneys' Offices and the Criminal Division's Child Exploitation and Obscenity Section, Project Safe Childhood marshals federal, state and local resources to better locate, apprehend and prosecute individuals who exploit children via the Internet, as well as to identify and rescue victims. For more information about Project Safe Childhood, please visit www.projectsafechildhood.gov.

For Sale: oak Wood Mulch



Mushroom Compost Topsoil.



Firewood

Call Steve Spoon
986-4282

West End Storage & Warehouses
502 Ward Avenue • Loudon
Call 865-458-4774 or 865-679-5555

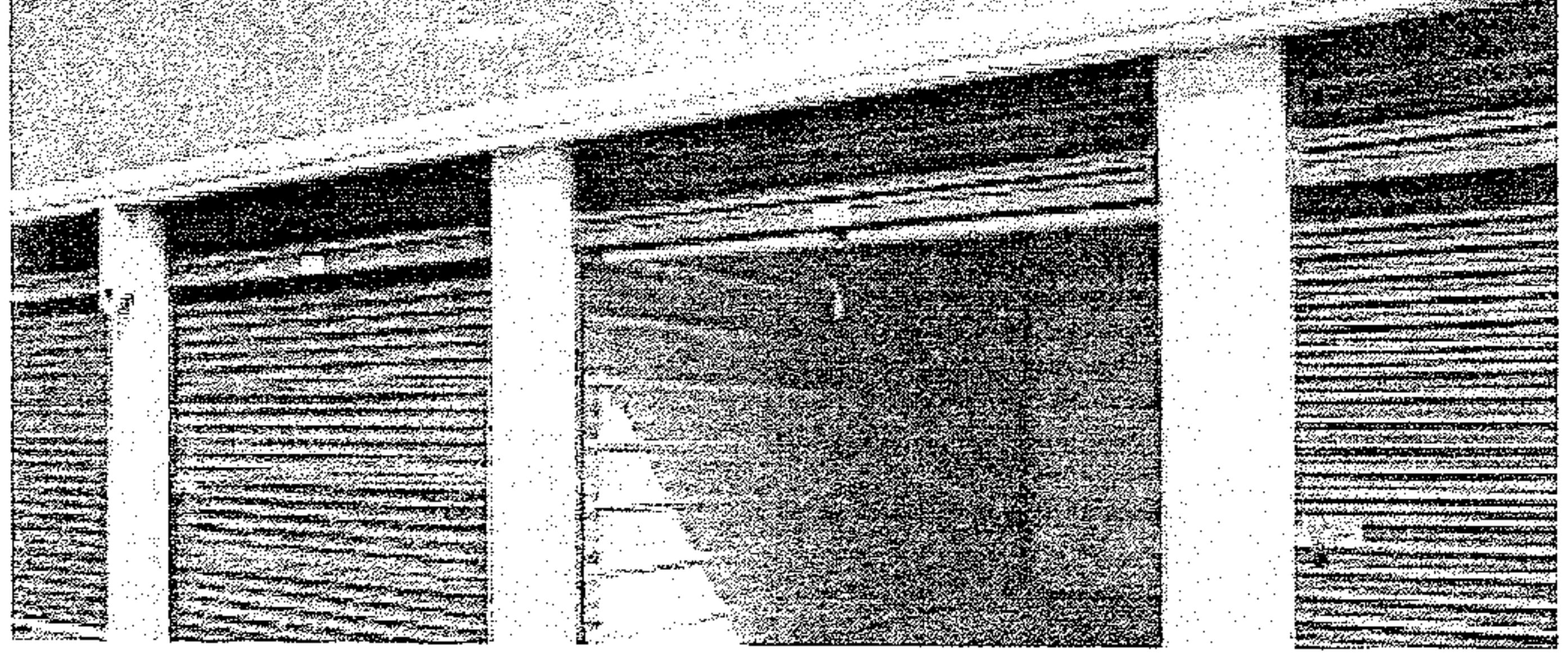

STAINED INK

TATTOO & PIERCING
LENOIR CITY 865 816-6440
NEW OWNER • NEW ARTIST • SINCE 2011
521 Hwy 321 next to Vape & Stuff & Inn Of Lenoir!
Clean-Affordable-Quality-Custom
Tattoo's You've Always Wanted!

BRING IN THIS AD FOR **\$25 OFF!**
NEW INK FOR NEW CUSTOMERS ONLY!

Check us out on FB.com/
Stained.Ink.Tattoo/
www.STAINEDINK.com

C&J Towing and Recovery

LOWEST TOWING RATES AROUND!!!

Have you been overcharged for any type of towing service in the Lenoir City area? If you have a breakdown or accident please **OWNER REQUEST C&J Towing** with the officer. Also please call your Sheriff and ask him to place C&J Towing on the "Rotation List*" and help other motorists save as much as you did! We at C&J are locally owned and operated, State approved, licensed, bonded and insured. Call and let us know if your denied service or how we can be of assistance.

*note: the "Rotation List" is a list of wrecker services that provide service for wrecks, DUI's, breakdowns, etc. and are on an on-call basis for service. This list is approved by the Sheriff.

Cliff Teeters • Owner
865-809-1661

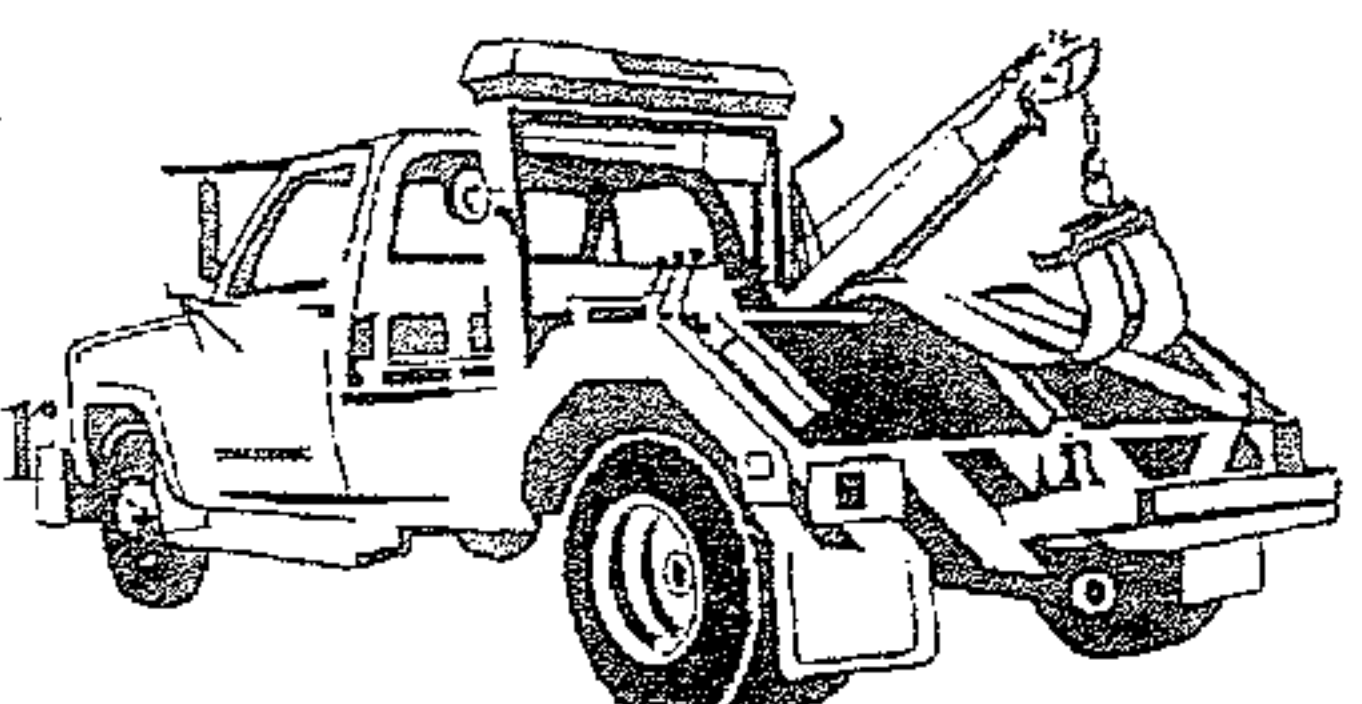

BIMBO'S

Deli Open 24 Hours
865-986-9643 Call Ins Welcome

Specials

Lg. Cold Sub, bag of chips and 16 oz. fountain drink only \$6.29

Footlong Corn Dog \$2.59

Haslam
our constitutional officers and this administration.

“By managing wisely and investing strategically, we’re making tax

dollars work harder for Tennesseans. This is what we do.”

Haslam’s budget proposal builds up state reserves, puts Tennessee on the path to catch up

on long-deferred maintenance of buildings, reinvests in the state workforce and focuses one-time dollars on reducing the state’s ongoing costs.

“This is our opportunity. Let’s bear down on what we can do together, keeping Tennessee a state with a strong financial condition, helping Tennessee to be the No. 1

location in the Southeast for high quality jobs, and making certain that all Tennesseans regardless of their circumstances have an opportunity for a high quality education,” Haslam said.

Including the current fiscal year’s appropriation, state government will invest more than 414 million in new dollars in Tennessee schools, more

than \$200 million of that toward increases to teacher salaries. Additionally, Haslam proposed funding the 12th month of health insurance for teachers and doubling the state’s recurring contribution for technology needs at schools.

“What’s important in all of this is that we’re not investing in the same old public education system in Tennessee. We’ve raised our standards. We’ve linked teacher evaluations to student performance, and we’ve expanded education options for children. We’re showing historic progress, and we can’t back up,” Haslam said.

The governor’s proposal puts \$100 million into the state’s Rainy Day Fund, bringing it to an estimated \$668 million on June 30, 2017; \$60 million for salary increases for state employees; and another \$36 million for market rate adjustments for state employees making less than \$50,000 annually.

Haslam proposed significant investments in higher education and the Drive to 55 initiative, the state’s effort to increase the number of Tennesseans with a postsecondary credential to 55 percent by 2025, including:

\$50 million for the Complete College funding formula for higher education;

\$20 million for the Drive to 55 Capacity Fund to help community and technical colleges meet the growing demand for degrees and certificates; and

\$10 million for the Labor Education Alignment Program (LEAP) helping communities align degree and course offerings with the needs of the local workforce.

The proposal invests \$581.6 million in state and other funds to build see Haslam etd. pg. 7

PUBLIC NOTICE

Loudon County Government
Surplus Equipment Sale

Loudon County Government has for auction on GovDeals.com the following:

(4) 1996 New Holland Tractors Model #6610 including (3) side mowers and (2) 2008 Landini Powerfarm Tractors including (1) boom mower.

Descriptions and pictures of items are available on the GovDeals.com website. The Closed Auction Date for the tractors and mowers is February 15, 2016 at the times specified on the auction page. Interested bidders can contact Teresa Everett at 865-458-4663. Loudon County Government will not discriminate on the basis of sex, race, national origin, creed, age, marital status or disability.

Lenoir City Planning and Codes Department Public Notice

Public Hearing

The Lenoir City Mayor and City Council will hold a public hearing on Monday, February 22, 2016 at 6:55P.M. at Lenoir City Hall to consider final passage of the following ordinance:

AN ORDINANCE TO AMEND THE ZONING MAP OF THE CITY OF LENOIR CITY, TENNESSEE PURSUANT TO §13-7-204 OF THE TENNESSEE CODE ANNOTATED, TO REZONE PROPERTY LOCATED OFF HALL STREET FROM R-1-S SINGLE FAMILY RESIDENTIAL DISTRICT AND C-3 HIGHWAY COMMERCIAL DISTRICT TO R-2 MEDIUM DENSITY RESIDENTIAL DISTRICT.

A copy of the proposed ordinance is available for review at the Lenoir City Office of Codes Enforcement and Planning, 600 E. Broadway, Lenoir City, TN, or you may call 865-986-7224 during business hours for assistance.

How about \$50 you didn't have before?

Just come to Liberty Tax, let us do your taxes and we'll hand you \$50 cash on the spot.

119 E. Broadway Street

Downtown Hwy 11

820 Hwy 321 N

Across from Burger King

Lenoir City, TN 37771
865-986-8335

with paid tax preparation. Valid at participating locations. Cannot be combined with other offers or used toward past services. One coupon per return. Expires 2-15-15



BUDGET Transmissions

302 S. Northshore Drive Knoxville

(865) 584-4391 budget-transmissions.com

Why Buy From Budget?

Free Towing From Lenoir City or Loudon County

20 Years of BBB Zero Customer Complaints Award Member

A+ Plus Rated

Huge Transmission Inventory

Best Technicians Period!!!

Call (865) 584-4391 Today!

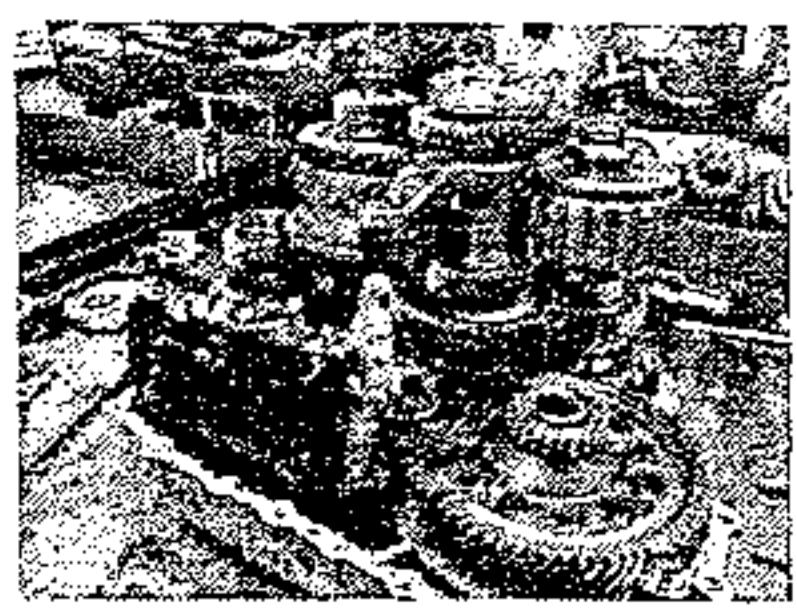

Approved Auto Repair



APPLY FOR AN EASY ADVANCE AND GET MONEY FAST!

\$750 Easy Advance at Liberty Tax at No Additional Cost!

820 Hwy 321 N

Across from Burger King

119 E. Broadway Street

Downtown Hwy 11

Lenoir City, TN 37771

865-986-8335

An Easy Advance (EA) is a \$750 loan secured by your tax refund and is offered by Republic Bank & Trust Company, member FDIC, to qualifying applicants. There are no fees or interest associated with the EA. Subject to approval. Visit your Liberty office to learn more. Offer Expires 2-28-15.



JD the Jack Daniel Distillery for their continued investment in Lynchburg and bringing us closer to making Tennessee the No. 1 location in the Southeast for high quality jobs."

"Tennessee is home to many brands known around the world, and of those brands, Jack Daniel's certainly ranks among the top of the list," Boyd said. "This year marks the 150th anniversary of the Jack Daniel Distillery and as one of the state's most respected

brands, we thank the company for its long history in our state and its continued contribution to Team Tennessee."

The Jack Daniel Distillery underwent a separate expansion less than three years ago which included the addition of stills, barrel warehouses and related infrastructure. The project represented an investment of \$103 million and the creation of 94 jobs.

"The bourbon and American whiskey category is booming, and we appreciate the support of

our Tennessee state and economic development officials as we work to meet global demand for Jack Daniel's," said Larry Combs, SVP General Manager Jack Daniel's Supply Chain. "We are especially proud that this second expansion announcement comes as we celebrate the 150th anniversary of the Jack Daniel Distillery, America's Oldest Registered Distillery."

In addition to the new barrelhouses and bottling facility modifications, the current expansion will

also involve renovations to the Visitor Center to support increased tourism and enhance the visitor experience. Last year, the Distillery received more than 275,000 guests from around the world.

"Lynchburg is proud to be home to America's oldest registered distillery and a world class tourist destination," Metropolitan Lynchburg-Moore County Mayor Sloan Stewart said. "Jack Daniel's is an outstanding corporate citizen, and we appreciate all that they have done to give

back to the community. We congratulate them on the expansion and look forward to many years of success in the future."

"TVA and Duck River Electric Membership Corporation congratulate the Jack Daniel Distillery on its latest plans to expand and create new jobs and investment in Lynchburg," TVA Senior Vice President of Economic Development John Bradley said. "It's always an exciting day when an existing company is committed to continuing growth in our rural communities. We are pleased to partner with the Tennessee Department of Economic and Community Development, city of Lynchburg and Moore County to celebrate Jack Daniel's ongoing business success and longstanding commitment to grow in the Valley."

Lynchburg and Moore County are represented by Sen. Jim Tracy (R - Shelbyville) and Rep. David Alexander (R - Winchester) in the Tennessee General Assembly.

About the Jack Daniel Distillery

Officially registered by the U.S. Government in 1866 and based in Lynchburg, Tennessee, the Jack Daniel Distillery, Lem Motlow, proprietor, is the oldest registered distillery in the United States and is on the National Register of Historic Places. Jack Daniel's is known for the world-famous Jack Daniel's Old No. 7 Tennessee Whiskey, Gentleman Jack Rare Tennessee Whiskey, Jack Daniel's Single Barrel Tennessee Whiskey, Jack Daniel's Tennessee Honey, Jack Daniel's Tennessee Fire, Jack Daniel's Ready-to-Drink Beverages and Jack Daniel's Country Cocktails. Please enjoy your Tennessee Whiskey responsibly. For more information on Jack Daniel's, visit www.jack-daniels.com or visit Face-

(see JD ctd. pg. 6)

PURDY'S AUTO PARTS AND SALVAGE

WE BUY SCRAP IRON • COPPER • BRASS • ALUMINUM

\$ **Paying Top \$\$\$**
Call For Latest Prices

You Name It, We Buy It!

Radiators, Wheels, Batteries, Appliances, Farm Equipment

Complete Cars
per 100 lbs.

Scrap Metal
Paying Top \$\$\$
Call For Latest Prices
per 100 lb

Copper
Paying Top \$\$\$
Call For Latest Prices

We Buy Batteries

Aluminum Cans
Paying Top \$\$\$
Call For Latest Prices

You Call We Haul!

423-519-5402

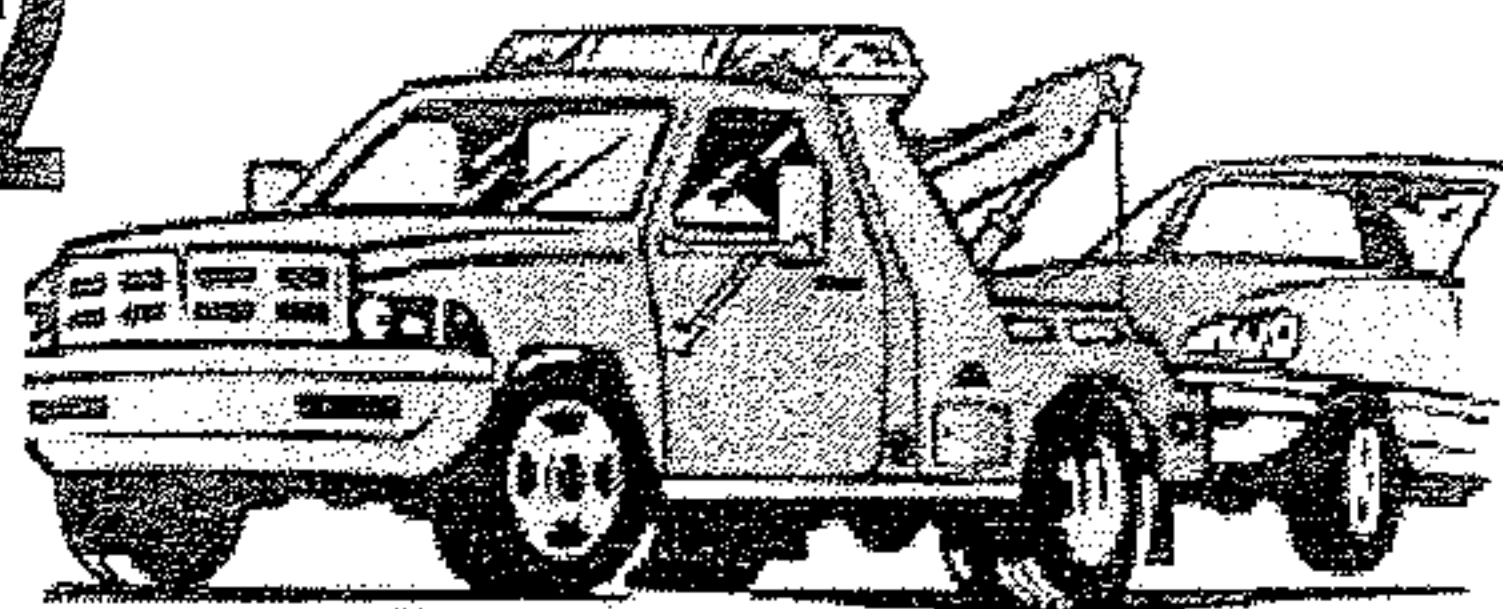

Prices subject to change with the market.

**Now Selling
Aftermarket
Body Parts at
Discount Prices**

423 337-3977

149 County Road 323 Sweetwater

Prices subject to change with the market.

DV

Jorge Abrego, 22, Main Street Loudon, was charged with Domestic Assault, and Violation of Probation.

Officer Pierson was dispatched to main street Loudon, Tn for a report of a fight in progress. Officer arrived on scene and made contact with both complainants a and a female identified herself as Mr. Abrego's girlfriend and advised Officer that she was trying to leave in her car and Mr. Abrego would not let her leave. Victim then came back inside and tried to call her mother and stated that is when Mr. Abrego became

aggressive and started pushing her and pulled her hair. She also stated to Officer that she tried yelling for help and he grabbed her mouth in an effort to keep her quiet. Mr. Abrego admitted to trying to keep her from leaving and also stated that he did push her. Victim did have red marks on her neck and chest and around her head and cheeks on her face. Her jacket was also ripped. Victim sister also witnessed some of the altercation. Witness advised she did see Mr. Abrego push victim when they where inside the residence then she left the room. Witness also filled out a statement of what she saw. Mr. Abrego

was placed in custody and transported to the Loudon County Jail. Haslam ctd. from pg. 4

new buildings and fix existing higher education and general state government facilities. This includes the top recommended capital projects for both the University of Tennessee (UT) system and the Tennessee Board of Regents (TBR):

\$85.5 million for a new Tennessee Tech University laboratory science building;

\$39 million for a new dentistry building at the UT Health Science Center in Memphis;

\$38.8 million for Tennessee State University's new health science building; and

\$36 million for renovations to UT-Chattanooga academic buildings.

Other notable budget

investments are:

\$130 million from the General Fund to repay the Highway Fund;

\$24 million in state funds for the Employment and Community First (ECF) CHOICES program to allow the state to serve more people currently on the Department of Intellectual and De-

velopmental Disabilities' waiting list and others eligible for services;

\$12.8 million for facilities and homeland security upgrades for the Military Department;

\$10 million for the Department of Economic and Community Development's Rural Development Initiative; and see Haslam conc. pg. 8

JOB OPENING

Loudon County Habitat for Humanity Home Store has an opening for an Associate. This 30-hour a week position provides services related to the pickup of donated goods outside the store, and the movement of donations in the store. Assists with scheduling, determining routes, and driving the store truck. Must be able to lift 50 pounds and be able to read a map and follow directions. Must have a valid driver's license. Must be adaptable to rapidly changing conditions and have good interpersonal skills. Applications available at the store T-F 9:00-5:00 and Sat. 8:00-1:00. 303 Simpson Road East, Lenoir City. Drug Free Workplace - EOE

LOOK! \$75 Weekly Payments LOOK!

MARTY'S AUTO SALES • 986-2222 • MARTY'S AUTO SALES • 986-2222 • MARTY'S AUTO SALES • 986-2222 • MARTY'S AUTO SALES • 986-2222 • MARTY'S AUTO SALES • 986-2222

Bad Credit
Divorce
Fixed Income
Repos
Bankruptcy
No Credit

APPROVED! **NO CREDIT CHECKS**

Visit Us On The Web At:
martysautosales.net

| | | | |
|--|--|--|--|
|  <p>\$499 down*</p> <p>07 Cobalt, 5spd, gas saver, runs great Only \$499 down *</p> |  <p>\$299 down*</p> <p>99 Solara, V6, auto, sporty, Only \$299 down*</p> |  <p>\$599 down*</p> <p>04 Santa Fe, auto, Nice, clean. Only \$599 down *</p> |  <p>\$499 down*</p> <p>01 Sebring 2dr. sporty, Only \$499 down *</p> |
|  <p>\$499 down*</p> <p>05 Sedona, Runs Great, Only \$499 down *</p> |  <p>\$399 down*</p> <p>01 Rodeo, 4cyl, 5spd, Gas Saver Only \$399 down *</p> |  <p>\$499 down*</p> <p>99 Grand Cherokee, Loaded, lthr, Only \$499 down *</p> |  <p>\$99 down*</p> <p>98 Bonneville, 6 cyl, Auto, low payments only \$99 down *</p> |

NO Credit Checks **Marty's Auto Sales 986-2222** **100% Approval*** *Se Habla Espanol*

*See Dealer for details. All down payments plus tax, tag, title and fees.

MARTY'S AUTO SALES • 986-2222 • MARTY'S AUTO SALES • 986-2222 • MARTY'S AUTO SALES • 986-2222 • MARTY'S AUTO SALES • 986-2222 • MARTY'S AUTO SALES • 986-2222

Haslam conc. from pg. 7

\$1.27 million to increase the number of drug recovery courts from 41 to 50 and for two additional veterans courts.

The complete text of the governor's speech, an archived video and budget documents will be available at <http://tn.gov/governor/topic/state-of->

the-state.

See more at: <https://www.tn.gov/news/23847#sthash.sK3p4xwQ.dpuf>

To Advertise for as low as \$1 per day Call 865-771-2249

THE RELIC SHOP

521 Hwy 321 Lenoir City Suite 3
next to Stained Inc and the Inn of Lenoir
865-250-9280

WE ARE IN TUCSON, ARIZONA BUYING UP FOSSILS FOR THE SHOP. WE NEED TO MAKE ROOM!!!

ALL AMETHYST 40% OFF

GREAT SELECTION OF ANCIENT MEGALADON SHARK TOOTH OVER 8 MILLION YEARS OLD

Is Your Washer Broken?

Call Me

I Only Charge \$100 Period!!!

Call Allen

865-617-7113

A Name You Already Know And Trust Just Got Even More Dependable
DEPENDABLE AUTO SERVICE, LUBE AND TIRES
is Now Offering

Expert, Affordable Transmission Service

All ASE Certified Technicians

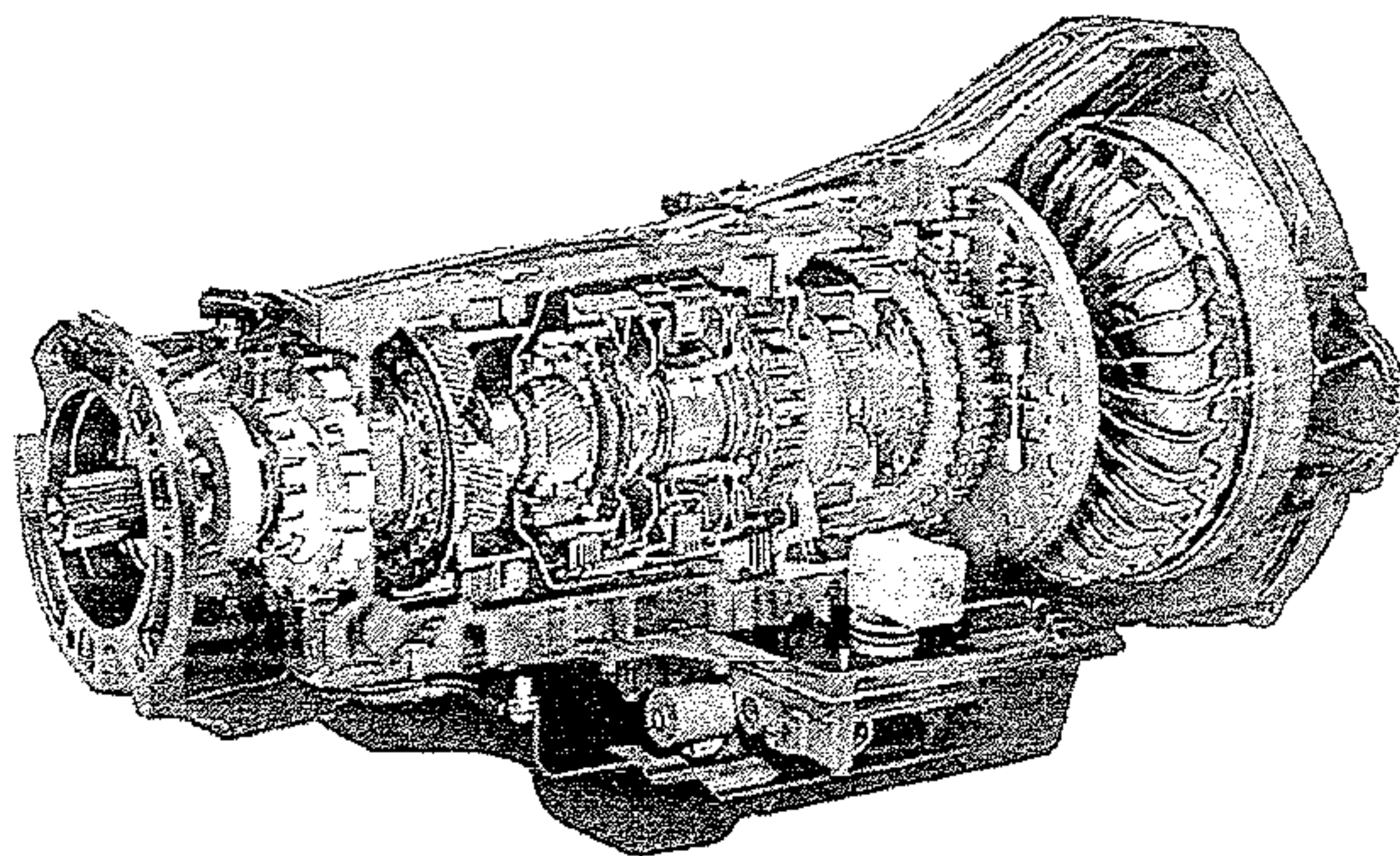

We proudly welcome all New Customers and Former Advanced Transmission Customers with a 10% Discount and Any Transmission Service or Repair*

865-986-9359

865-986-5050

Bad Credit, No Credit OK!!! We Finance Everybody!!!

Taxes Done Here!!! Bring your last pay stub or W2 and DRIVE TODAY!!!

Over 100 Cars, Trucks & Vans in Stock - Warranties On ALL Vehicles Sold!!!

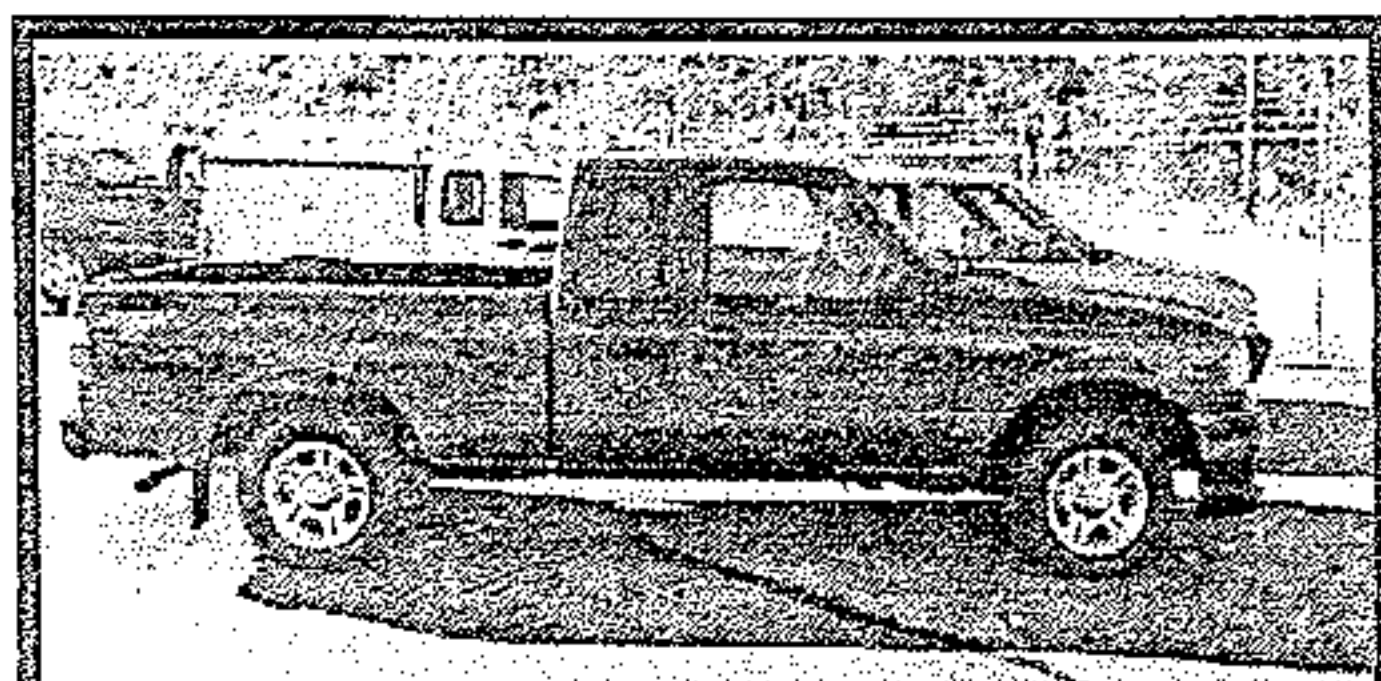

2005 Ford Ranger, Super Nice Truck, Very Low Miles

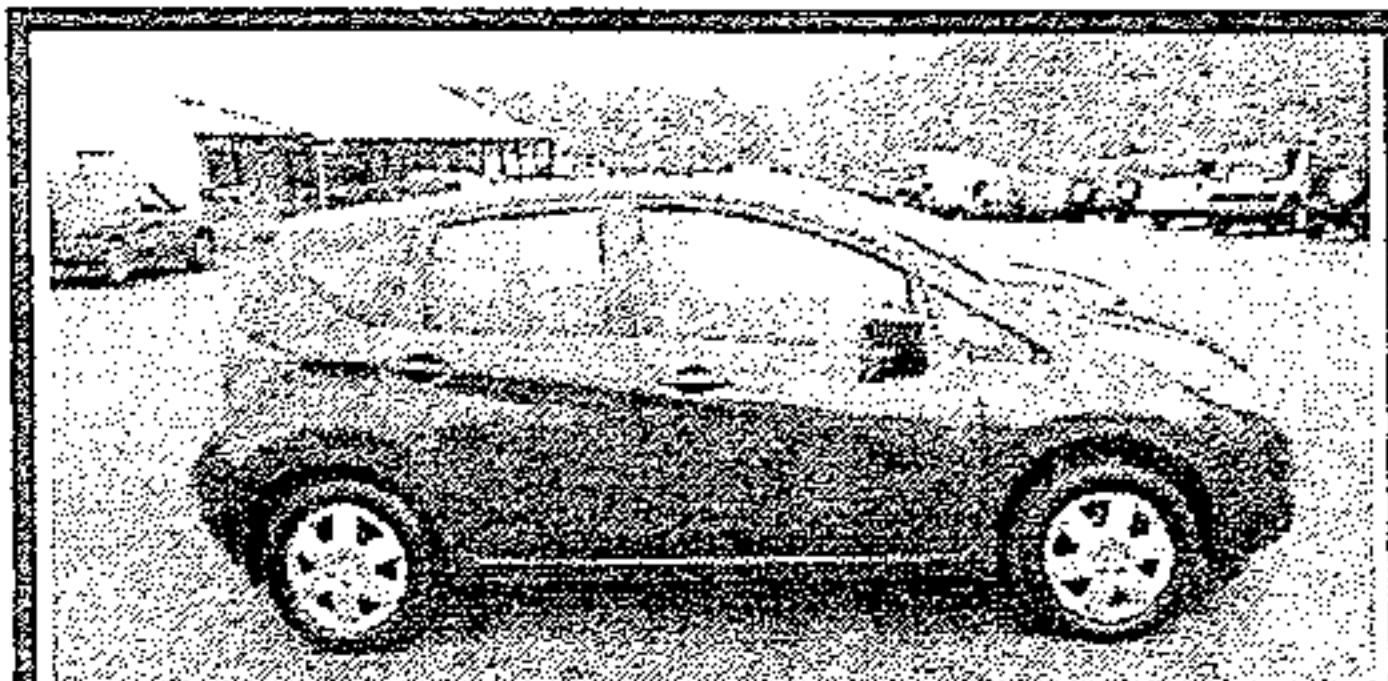

2015 Nissan Versa Note, Factory Warranty, Low Miles

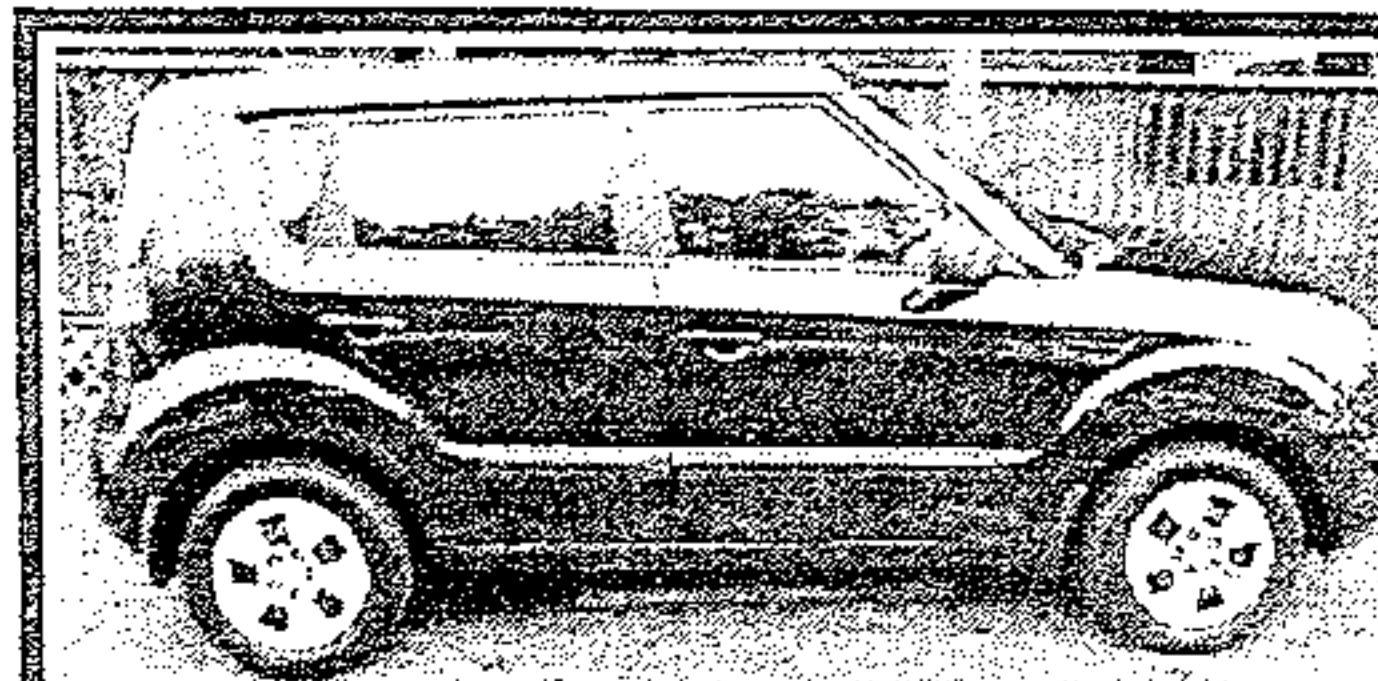

2011 Kia Soul, 5 speed, 4 dr, Gas Saver, Nice & Clean



2007 Chevy Equinox, 4dr, Extra Clean, lots of room

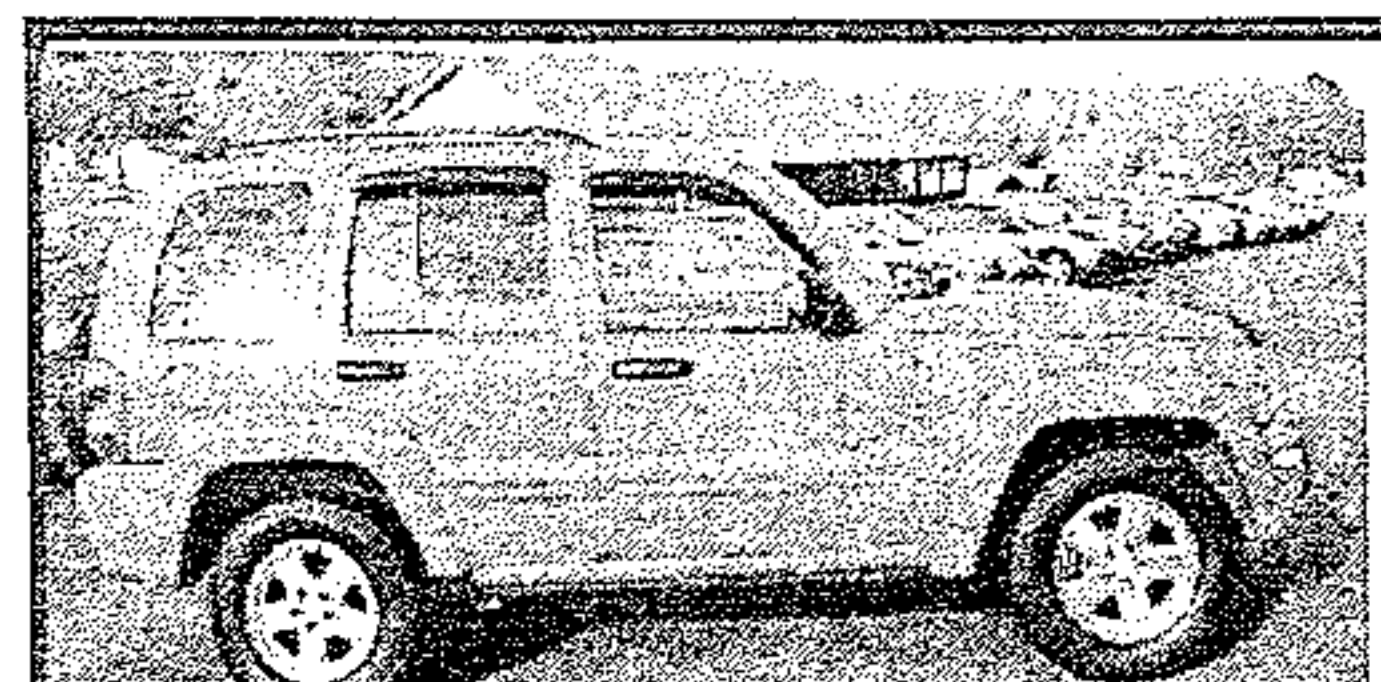

2004 Jeep Liberty, 77k miles, Leather, LOADED!!!

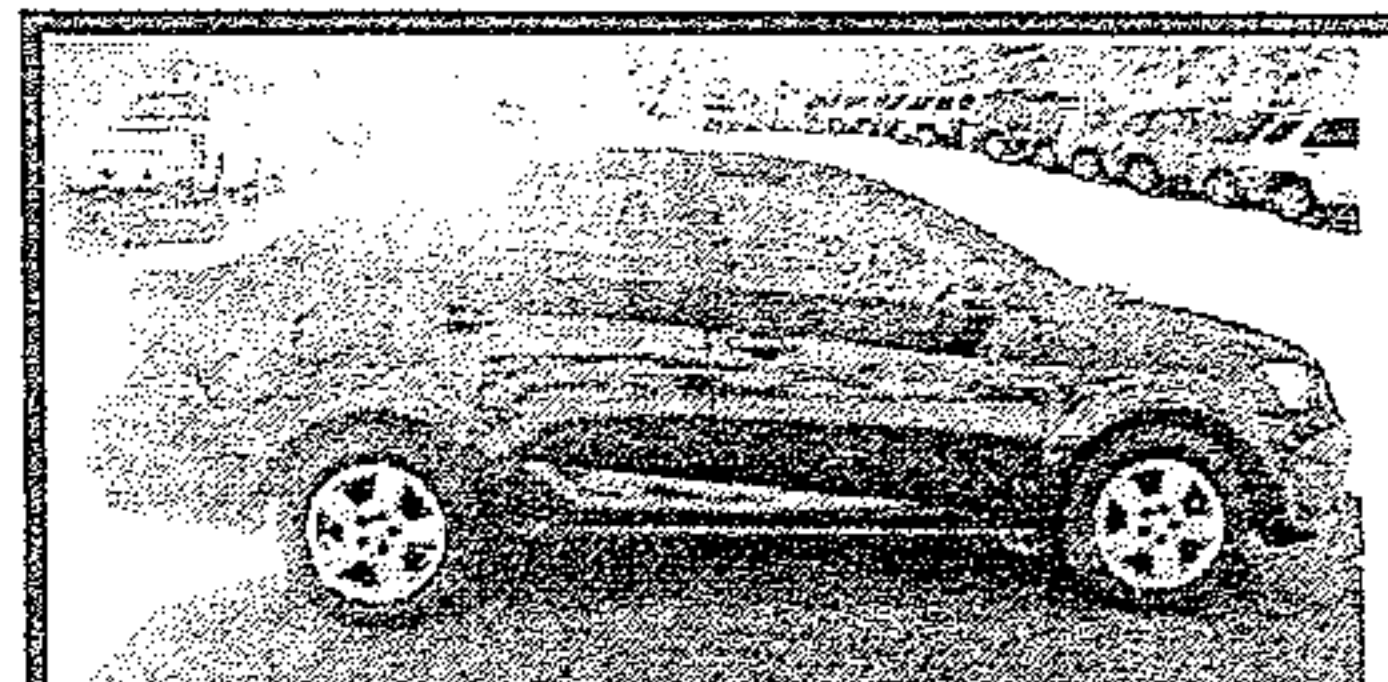

2014 Chevy Sonic, Factory Warranty, Low Miles!

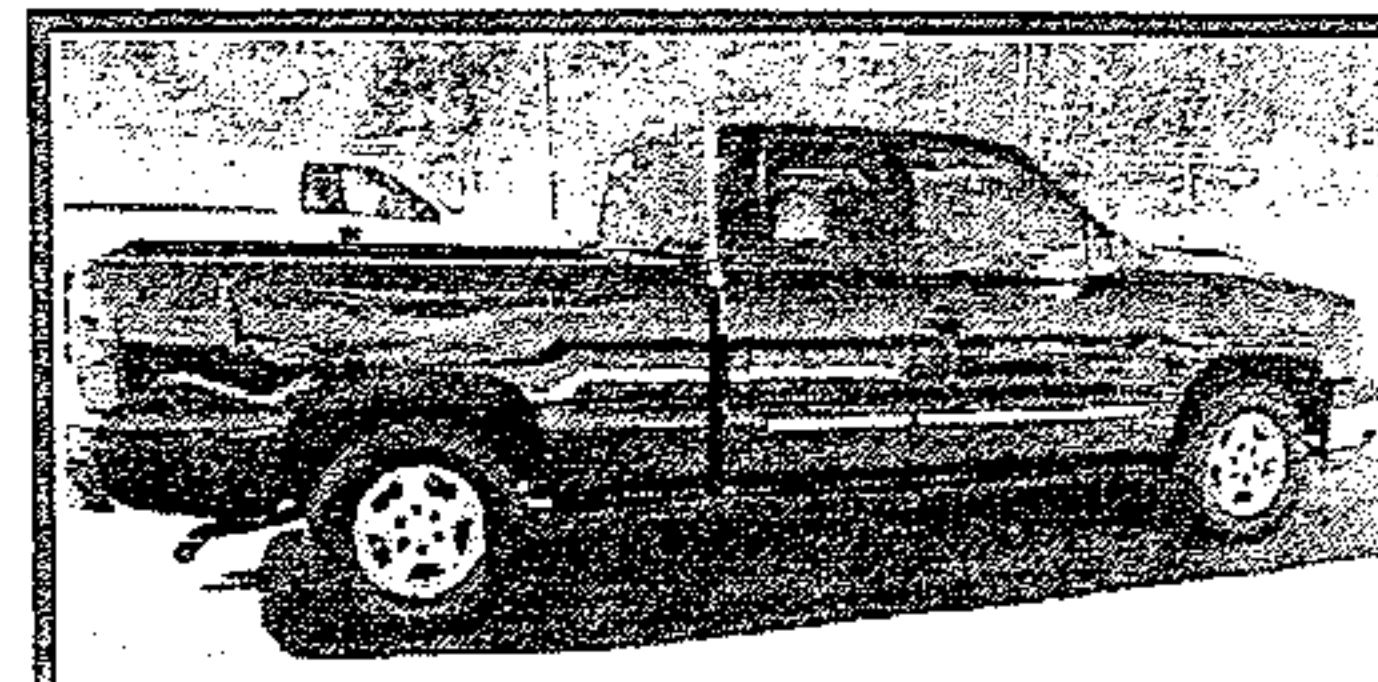

2004 Chevy Silverado, Loaded!, Nice Truck

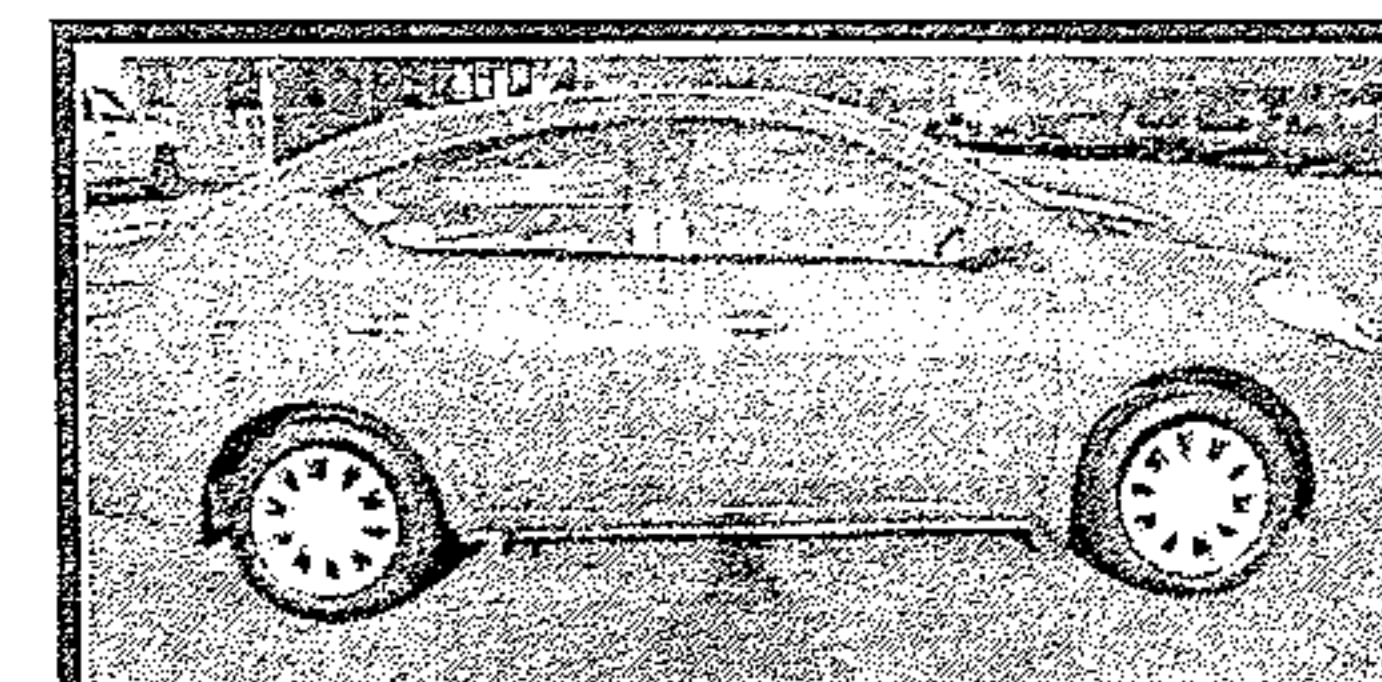

2013 Nissan Versa, Like New!, LOADED!!!

WALT WILLIAMS, INC.

*with approved credit

3003 Highway 11 Lenoir City, TN 865-986-1111