

The Daily Edition

50¢

Serving Loudon, Monroe and Surrounding Counties

Monday, February 1, 2016

Suicide call ends with load of charges; Man cuts wrists then attacks police in jail rampage

Timothy McCauley, 35, Knox Street Philadelphia, was charged with Aggravated Assault x2, Disorderly Conduct, and Resisting Arrest.

Deputy Kenneth Palmer LCSO, was dispatched to Washington Pike to a possible attempted suicide. Dispatch advised the sub-

(see assault pg. 2)

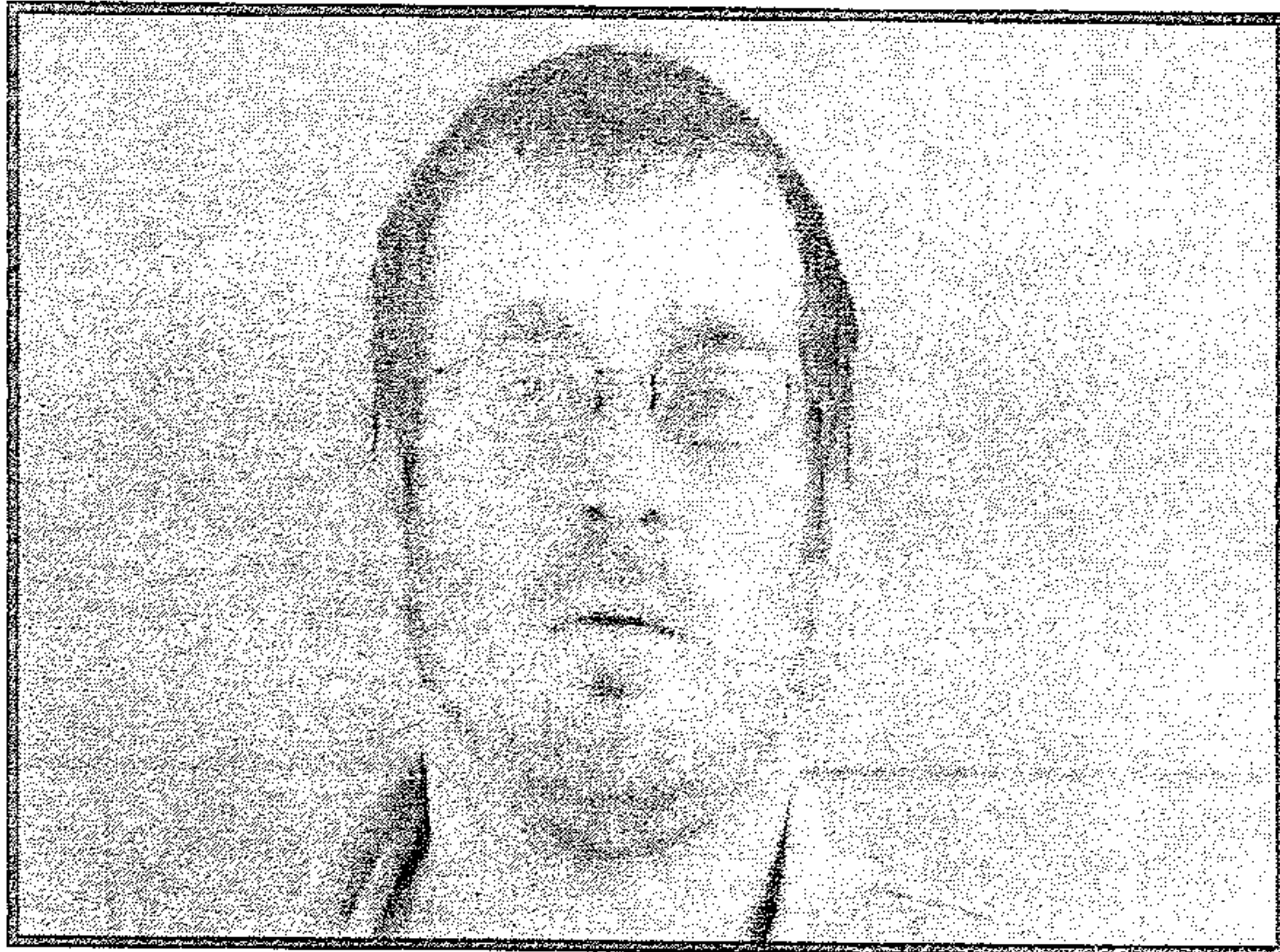

Timothy McCauley

Loudon Man charged with solicitation of minor



Pedro Aguilera

(see minor pg. 5)

Meth found; 2 charged after traffic stop



Lucas Massey

(see meth pg. 7)



Otto Flachbart

Joyriding teen charged

(see teen pg. 7)



Patrick Vought

Investigations Reveal Theft from Clay County Rescue Squad and Pea Ridge Volunteer Fire Department

The Tennessee Comptroller's Office has released two special investigations involving the theft of mon-

Training Together

New FBI Academy Program Integrates Agents and Intelligence Analysts

Today's special agents and intelligence analysts graduating from the FBI Academy are beginning their first assignments fully prepared for collaborative work in the field thanks to an innovative training program

launched in 2015.

Dubbed the Basic Field Training Course (BFTC), the new program offers an integrated curriculum that places new agent and intelligence analyst trainees together in a squad-like environment—the way agents and analysts work in actual FBI field offices. During the course, trainees learn skills like conducting investigations, interview-

ey from the Clay County Rescue Squad and the Pea Ridge Volunteer Fire De-

(see theft pg. 3)

Verse of the Day

Then I said to you, "Do not be terrified; do not be afraid of them. The LORD your God, who is going before you, will fight for you, as he did for you in Egypt, before your very eyes." — Deuteronomy 1:29-30

Obituaries

see inside **Wazzup**
Glad to see the temperatures warming up? Don't get used to it, you know East TN weather, it'll come when you

least expect it!

Weather

Today: Cloudy with showers. High around 60F.
Tonight: Mostly cloudy skies early will become partly cloudy late. Low 48F.
Tuesday Partly cloudy skies. High near 70F.
Tuesday Night Thunder-

storms during the evening will give way to steady rain overnight. Potential for severe thunderstorms. Low 48F.

Horoscopes

Aquarius 1/20-2/19

You have a lot on your mind today, but might

(Continued on page 6)

(see training pg. 4)



assault

ject was cutting his wrist with a knife. When Deputy got in the area dispatch advised the subject was coming down the driveway. Deputy observed the vehicle in driveway at which time he activated his lights and the truck came to a stop. Deputy ordered the subjects in the vehicle to show him their hands at which time Deputy got the driver out and detained him. Deputy then had the passenger Mr. Tim Mccauley exit the vehicle at which time he identified him as the subject that was trying to cut his wrist. Deputy observed five superficial cuts

on Mr. Mccauley's wrist. Priority ambulance did respond to the scene and check Mr. Mccauley's wrist. Mr. Mccauley became very uncooperative with EMS, Cpl Branam 922, and Deputy Palmer. Deputy advised Mr. Mccauley to calm down at which he continued to escalate the situation by cursing and yelling. Deputy then escorted Mr. Mccauley to his vehicle at which time Cpl. Branam and Deputy Palmer advised him to have a seat. Mr. Mccauley continued to refuse and Cpl. Branam and Palmer had to force Mr. Mccauley into the patrol vehicle. Mr.

assault ctd. pg. 7

Get Paid To Wave!
Now Hiring Wavers at Liberty Tax
 Apply in person at Liberty Tax, East Broadway Lenoir City or Hwy 321 Lenoir City. Must be dependable, and ready to work.

Notice
 Reward offered for the return of a handmade black walnut baby cradle and 700 strands of African trade beads stolen from our home. If you have any information please call 865-250-9280.

Notice: The Daily Edition does not knowingly accept fraudulent or misleading materials. The Daily Edition cannot guarantee the validity of offerings or statements contained herein. All liability for the contents of all advertising, and for any claims that may arise therefrom, is the responsibility of the advertiser or its agency. The Daily Edition reserves the right to reject, edit, or abbreviate any advertisement submitted. Advertising is accepted with the understanding that all liability for all copyright violations is the sole responsibility of the advertiser. Photographs, artwork and other copy submitted for publication is considered the sole property of the advertiser. The Daily Edition will make every effort but will not be liable for failure to publish and ad or for typographical and layout errors. All statements and information about highlights featured items, letters to the editor, herein are those solely given to the interviewer or writer and the Daily Edition assumes no responsibility of the accuracy or validity thereof. The Daily Edition will gladly reprint at no charge that part of an advertisement in which an error occurs provided a claim is made within 3 days of the first publication of the ad. Information contained in the Wazzup is received anonymously and the Daily Edition assumes no responsibility for information and reserves the right to edit or reject any and/or all submissions. The Daily Edition is a daily newspaper of general circulation in Loudon County defined under TCA 2-1-104(a)(13). The Daily Edition also serves Monroe, Knox, Anderson, Roane and Blount counties and serves 30,000 readers weekly. Send mail to PO Box 1240, Lenoir City TN 37771. 865-771-2249. email: dan1204us@yahoo.com
 The Daily Edition is Loudon County's premier public interest and paid advertising paper. The Daily Edition is produced and published daily Monday through Friday and is circulated throughout Loudon County and parts of Monroe and Knox Counties. Display advertising rates \$5.00 per column inch and quantity discounts available. Call for information on upcoming promotions and events.

Public Notice
 The Loudon County Corrections Partnership Committee will meet February 10th, 2016 at 12:00 at the Justice Center to discuss future plans.

Good Credit OK • Bad Credit OK • Bankruptcies OK • Repo OK



2010 Kia Soul Sporty, 4 cyl, Auto, PW, PL, A/C, Great On Gas, Like New



2010 Ford Escape Limited Leather, Alloy Wheels, Heat, A/C, Luggage Rack, 79K,



2007 Dodge Ram 1500 Quad Cab, Thunder Road PKG, 20 in. Wheels, Low Miles, Hemi



2008 Ford Explorer 84k, 3rd Row Seating, Luggage Rack, Tow Pkg, PW, PL



2011 Ford Ranger Low Miles, Tow Pkg, New Tires, A/C, Heat, Bed Liner.



2011 Dodge Grand Caravan DVD, Stow & Go, Loaded, Remote Doors, Rear A/C

DEPENDABLE MOTORS 986-9343
 803 E. Broadway • Lenoir City

Serving Loudon County for 20 Years

* WAC. See Dealer for details

Visit our website at: www.dependablemotorslc.com

theft
partment in Celina, TN. These investigations were completed in conjunction with the District Attorney General's Office of the 13th Judicial District.

The same man, Laurence Bradford Stafford, is at the center of both investigations. Mr. Stafford is the former Captain of the Clay County

Rescue Squad and the former chief of the Pea Ridge VFD.

Investigators found that from January 2013 through September 2015, Mr. Stafford used Rescue Squad funds totaling at least \$4,485 for his personal benefit or the personal benefit of others. Some of this money was collected during Rescue Squad fundraisers.

Additionally, Mr. Stafford charged, and allowed others to charge, fuel for personal use on the Rescue Squad's account. He also allowed undocumented reimbursement payments to himself and other Rescue Squad members from the Rescue Squad bank account. Investigators were unable to determine if the payments were for legitimate Rescue Squad expenses.

A separate investigation into the Pea Ridge Volunteer Fire Department revealed that former chief Stafford and his wife, former assistant fire chief Tabitha Stafford, took at least \$8,705 in Fire Department funds for their personal benefit. Mr. and Mrs. Stafford used the money to make purchases including two mobile homes and a vehicle. They received other payments totaling

\$4,475 for which there was no supporting documentation.

The Pea Ridge investigation also uncovered similar problems with allowing inappropriate fuel purchases and undocumented reimbursement payments with Volunteer Fire Department funds.

The Volunteer Fire Department's bank balance decreased from more than \$38,000 in April 2012, when Mr. Stafford became fire chief, to a deficit of \$62 in September 2015.

In December 2015, the Clay County Grand Jury indicted Laurence Bradford Stafford, Tabitha Stafford, and five others on several counts of theft and conspiracy to

commit theft.

"A simple change in the way money is handled could have prevented these thefts from occurring," Comptroller Justin P. Wilson said. "In both cases, officials failed to separate financial duties between multiple individuals and provide appropriate oversight. This problem is at the heart of nearly every theft we investigate."

To view both special investigation reports online, go to: <http://www.comptroller.tn.gov/ia/>.

If you suspect fraud, waste or abuse of public money in Tennessee, call the Comptroller's toll-free hotline at (800) 232-5454, or file a report online at: www.comptroller.tn.gov/hotline. Follow us on twitter: @TNCOT

For Sale: oak Wood Mulch

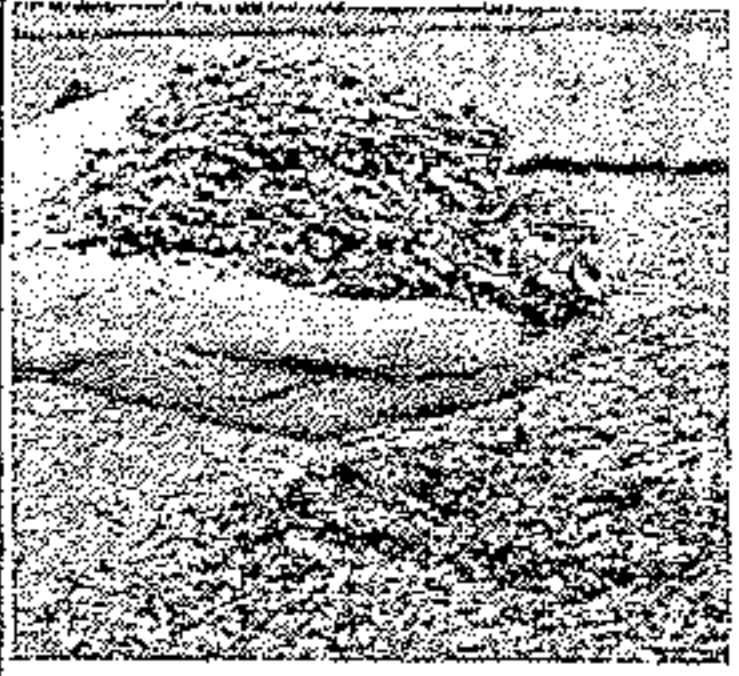

Mushroom Compost Topsoil.

Firewood



Call Steve Spoon 986-4282

West End Storage & Warehouses 502 Ward Avenue • Loudon Call 865-458-4774 or 865-679-5555



STAINED INK

TATTOO & PIERCING

LENOIR CITY 865 816-6440

NEW OWNER • NEW ARTIST • SINCE 2011

521 Hwy 321 next to Vape & Stuff & Inn Of Lenoir!

Clean-Affordable-Quality-Custom

Tattoo's You've Always Wanted!

BRING IN THIS AD FOR **\$25 OFF!**
NEW INK FOR NEW CUSTOMERS ONLY!

Check us out on FB.com/
Stained.Ink.Tattoo/
www.STAINEDINK.com

C&J Towing and Recovery

LOWEST TOWING RATES AROUND!!!

Have you been overcharged for any type of towing service in the Lenoir City area? If you have a breakdown or accident please OWNER REQUEST C&J Towing with the officer. Also please call your Sheriff and ask him to place C&J Towing on the "Rotation List*" and help other motorists save as much as you did! We at C&J are locally owned and operated, State approved, licensed, bonded and insured. Call and let us know if your denied service or how we can be of assistance.

*note: the "Rotation List" is a list of wrecker services that provide service for wrecks, DUI's, breakdowns, etc. and are on an on-call basis for service. This list is approved by the Sheriff.

Cliff Teeters • Owner

865-809-1661

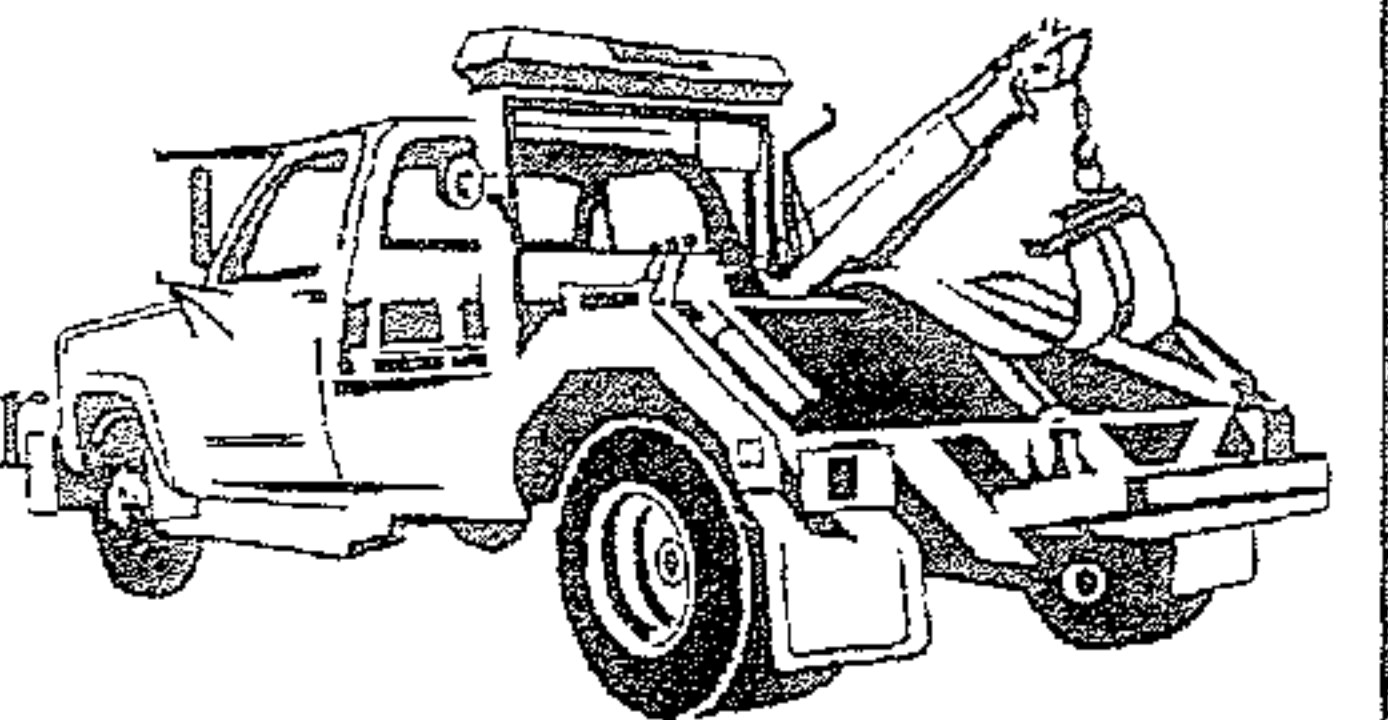

BIMBO'S

Deli Open 24 Hours

865-986-9643 Call Ins Welcome

Specials

Lg. Cold Sub, bag of chips and 16 oz. fountain drink only \$6.29

Footlong Corn Dog \$2.59

training

ing, and providing briefings. Their academic training culminates with criminal and counterterrorism exercises modeled after real-world scenarios.

“The BFTC serves as an important element of our continued efforts to improve collaboration throughout the organization,” said Mark Morgan, assistant director of the Bureau’s Training Division. “From their first days in the FBI, special agents and intelligence analysts sit side-by-side, wear the same uniforms, and learn the necessity of working as a single, integrated, cohesive team. This is an exciting shift in the way we do things.”

Prior to launching the BFTC, agents and intelligence analysts historically trained under separate programs. While the new program integrates train-

ees where appropriate, specialized courses are still provided to students based on what their roles will be in the field. For example, special agents are instructed on the fundamentals of operating firearms and tactical driving, while intelligence analysts are taught how to analyze emerging threats and provide intelligence reports.

“We changed the way our students learn by in-

tegrating special agent and intelligence analyst instructors in the classroom—the lessons are presented by a team,” said Zachary Lowe, chief of the Training Division’s Instruction Section. “Having great instructors with current field experience integrating intelligence and operations has been critical to the success of the BFTC.”

The first group of graduates to complete

the new training course walked across the stage at the FBI Academy this past fall to receive their credentials. One of those graduates was Alexandra, who now serves in the field as an intelligence analyst. Like other students in her class, Alexandra felt the program provided her with an invaluable experience.

“There was a great

deal of cohesion within our group. We didn’t see each other as agents and analysts—we were just one class,” she said. “Having this type of integrated training, I believe, is the right step for the future of the FBI. Since we’re going to be working together in the field, it only makes sense to start us off so that collab-

(see training ctd. pg. 5)

How about \$50 you didn't have before?

Just come to Liberty Tax, let us do your taxes and we'll hand you \$50 cash on the spot.

119 E. Broadway Street
Downtown Hwy 11
820 Hwy 321 N
Across from Burger King



LIBERTY TAX SERVICE
Lenoir City, TN 37771
865-986-8335

with paid tax preparation. Valid at participating locations. Cannot be combined with other offers or used toward past services. One coupon per return. Expires 2-15-15

APPLY FOR AN EASY ADVANCE AND GET MONEY FAST!

\$750 Easy Advance at Liberty Tax at No Additional Cost!

820 Hwy 321 N 119 E. Broadway Street
Across from Burger King Downtown Hwy 11

Lenoir City, TN 37771
865-986-8335

An Easy Advance (EA) is a \$750 loan secured by your tax refund and is offered by Republic Bank & Trust Company, member FDIC, to qualifying applicants. There are no fees or interest associated with the EA. Subject to approval. Visit your Liberty office to learn more. Offer Expires 2-28-15.

PUBLIC NOTICE

The Lenoir City Utilities Board conducts their monthly Board Meetings on the third Monday of every month at 4:00 p.m. The meetings are held in the Council Chambers of City Hall located at 600 East Broadway, Lenoir City, Tennessee 37771. The schedule for 2016 is as follows:

- January 18, 2016
- February 15, 2016 (Cancelled in Observance of President’s Day)
- March 21, 2016
- April 18, 2016
- May 16, 2016
- June 20, 2016
- July 18, 2016
- August 15, 2016
- September 19, 2016
- October 17, 2016
- November 21, 2016
- December 19, 2016

minor

Pedro Aguilera, 22, Upper Street Loudon, was charged with Solicitation of a Minor, and Contributing to the Delinquency of a Minor. On 10/9/15 Pedro Aguilera who is over the age of 18, did by means of electronic communication directly request, invite, and attempt to persuade victim who is under the age of 18 years old to have sexual inter-

course with him. If or when this act was accomplished it would constitute the offense of statutory rape due to the fact there is more than 4 years of age separation between Pedro and victim. The victim father has communicated with Pedro in the past to stay away from victim but Pedro refused to comply. A warrant was issued. On 1/27/16 Deputy Cody Bengel LCSO,

arrested Pedro at the Loudon County Jail. training ctd. from pg. 4 oration is the only thing we know.”

The BFTC was developed in response to a key recommendation made in the 9/11 Commission Report, which called for the FBI to integrate its workforce and implement a dedicated team approach to national security operations. The curriculum of the new program an-

swers this call by providing trainees with the necessary building blocks to further the FBI’s dual law enforcement and intelligence mission.

“Students completing the course now have a broader knowledge base to help them acclimate to the workforce,” said Catherine Fletcher, chief of the Training Division’s Curriculum Management Section.

Fletcher’s group played an integral role

in developing the program’s learning components. Numerous subject matter experts as well as Headquarters and field office personnel were enlisted to provide input on the fundamental aspects of the program. Once the course’s curriculum was produced, it was thoroughly reviewed to ensure the content was relevant, current, and met the needs of the FBI’s mission. In all, the program was built from the ground up over the span of three years.

“During the BFTC development process, we focused on areas that would deliver the foundational skills needed for agents and analysts to understand each other’s roles,” said Fletcher. “By bringing in specialists from the field, holding focus groups, and connecting to the FBI’s current policies and procedures, we believe that this new curriculum achieves the end goal of instilling a team culture.”

Now in its 10th month at the FBI Academy, the BFTC is providing hundreds of new agents and intelligence analysts with the tools to succeed in the field as a seamless unit. Over time, the program will continue to evolve as new investigative and intelligence-gathering techniques emerge.

“We all have a stake in this new holistic approach to training, and we’ll need to stretch and learn accordingly,” said Fletcher. “In the end, we’re working as equal partners to support the FBI and the intelligence community as a whole.”

Place Your Ad In The Daily Edition. Call 865-771-2249

PURDY'S AUTO PARTS AND SALVAGE

WE BUY SCRAP IRON • COPPER • BRASS • ALUMINUM

\$ **Paying Top \$\$\$**
Call For Latest Prices

You Name It, We Buy It!

Radiators, Wheels, Batteries, Appliances, Farm Equipment

Copper
Paying Top \$\$\$
Call For Latest Prices

Complete Cars
per 100 lbs.

Scrap Metal
Paying Top \$\$\$
Call For Latest Prices
per 100 lb

We Buy Batteries

Aluminum Cans
Paying Top \$\$\$
Call For Latest Prices

Now Selling
Aftermarket
Body Parts at
Discount Prices

You Call We Haul!
423-519-5402

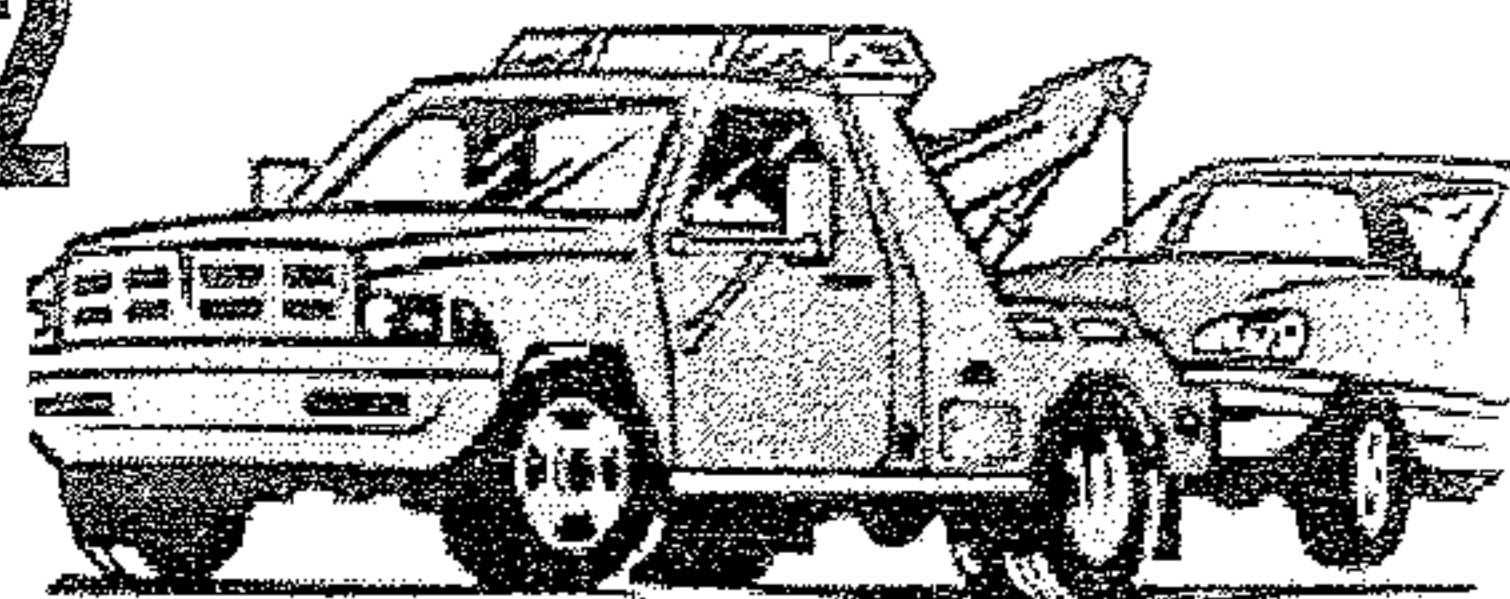

Prices subject to change with the market.

423 337-3977
149 County Road 323 Sweetwater

Prices subject to change with the market.

meth

Lucas Massey, 30, Calloway Circle Lenoir City, was charged with Man/Sell/Del/Resale SCH. II.

Otto Flachbart, 38, Shaw Ferry Road Lenoir City, was charged with Assisting other Agency.

Deputy Jamie Ketner LCSO, observed a vehicle failed to come to a complete stop at the corner of Midway @ Hwy 11. Deputy identified the driver and a front seat passenger as Otto Flachbart, and back seat passenger as Lucas Massey. The driver gave consent for Deputy Lane and Cpl. Chris Hutchens to search the vehicle. When Lucas exited the

vehicle Deputy noticed a small baggie where he was sitting. There was small crystals inside the bag and pieces in the floorboard where Lucas was sitting. A test of the crystals revealed them to be Methamphetamine. The weight was approx. .5 grams. Dispatched advised that Otto Flachbart had an active warrant out of Roane Co. After Lucas was searched 2 small baggies of crystal meth on Lucas. Deputy Jamie Ketner LCSO, made the arrest.

teen

Patrick Vought, 18, Abbott Road Lenoir City, was charged with Joyriding. Deputy Ben Everett LCSO, received a call from dispatch of

a theft of a motor vehicle at Abbott Road. Upon arrival Deputy came in contact with the victim who stated that between the hours of 2 am and 5 am Patrick took victim vehicle from the residence without permission. Patrick was traffic stopped by Morgan Co. Sheriff Office where he was detained. Patrick was transported back to Loudon Co. where Deputy Olwin Norman LCSO served a Joyriding Warrant on Patrick.

assault etd. from pg. 2

Mccauley continued to resist and began kicking Cpl. Branam several times in the legs and chest while placing him into the vehicle. When Deputy

arrived at the jail Mr. Mccauley continued to be very combative and would not exit the vehicle. Mr. Mccauley was removed from the vehicle and continued to curse and threaten officers. When Mr. Mccauley was inside the jail he became very

combative and started fighting officers. Deputies then tried to place Mr. Mccauley in the restraint chair at which time he trapped Deputy B. Smith right in the handcuffs. Deputy Smith did advise Mr. Mccauley to stop at assault conc. pg. 8

PUBLIC NOTICE

The Lenoir City Utilities Board will have a Special Called Meeting on Friday, January 29, 2016, at 11:30 a.m.. The meeting will be held at City Hall located at 600 East Broadway, Lenoir City, Tennessee 37771. The purpose of the meeting is as follows:

1. Consideration of approving the First Amendment to the Lenoir City Utilities Board Employees' Retirement Plan (to the Plan Document amended and restated effective December 21, 2015).

LOOK!
\$75 Weekly Payments
LOOK!

MARTY'S AUTO SALES • 986-2222
MARTY'S AUTO SALES • 986-2222
MARTY'S AUTO SALES • 986-2222
MARTY'S AUTO SALES • 986-2222
MARTY'S AUTO SALES • 986-2222

Bad Credit
 Divorce
 Fixed Income
 Repos
 Bankruptcy
 No Credit

APPROVED!

Visit Us On The Web At:

marty'sautosales.net

NO
 CREDIT
 CHECKS

\$499
down*

07 Cobalt, 5spd, gas saver, runs great Only \$499 down*

\$299
down*

99 Solara, V6, auto, sporty, Only \$299 down*

\$599
down*

04 Santa Fe, auto, Nice, clean, Only \$599 down*

\$499
down*

01 Sebring 2dr. sporty, Only \$499 down*

\$499
down*

05 Sedona, Runs Great, Only \$499 down*

\$399
down*

01 Rodeo, 4cyl, 5spd, Gas Saver Only \$399 down*

\$499
down*

99 Grand Cherokee, Loaded, lthr, Only \$499 down*

\$99
down*

98 Bonneville, 6 cyl, Auto, low payments only \$99 down*

NO
Credit Checks

Marty's

Auto Sales

986-2222

Se Habla Espanol

100%
Approval

*See Dealer for details. All down payments plus tax, tag, title and fees.

MARTY'S AUTO SALES • 986-2222
MARTY'S AUTO SALES • 986-2222
MARTY'S AUTO SALES • 986-2222
MARTY'S AUTO SALES • 986-2222
MARTY'S AUTO SALES • 986-2222

assault conc. from pg. 7
 which time he started
 squeezing harder on
 Deputy Smith's hand.
 Deputy's then used
 hard empty hand tactics
 to get his hand free.

Deputy did observe
 Deputy Smith had in-
 dentation's on his right
 hand from the cuffs.
 This did occur in

Loudon County TN,
 Deputy Kenneth
 Palmer LCSO, made
 the arrest.

To Advertise
 for as low as
 \$1 per day
 Call
 865-771-2249

THE RELIC SHOP

521 Hwy 321 Lenoir City Suite 3
 next to Stained Inc and the Inn of Lenoir

NOW OPEN
865-250-9280

WHERE A PERSON CAN BUY A PIECE OF HISTORY
 INDIAN ARTIFACTS, CIVIL WAR RELICS, FOSSILS
 ANTIQUE GUNS, ANTIQUE POCKETWATCHES,
 OLD COINS AND WHOLE LOT MORE!!!

Is Your Washer Broken?

Call Me
 I Only Charge \$100 Period!!!
 Call Allen
 865-617-7113

A Name You Already Know And Trust Just Got Even More Dependable
DEPENDABLE AUTO SERVICE, LUBE AND TIRES
is Now Offering
Expert, Affordable Transmission Service
 All ASE Certified Technicians

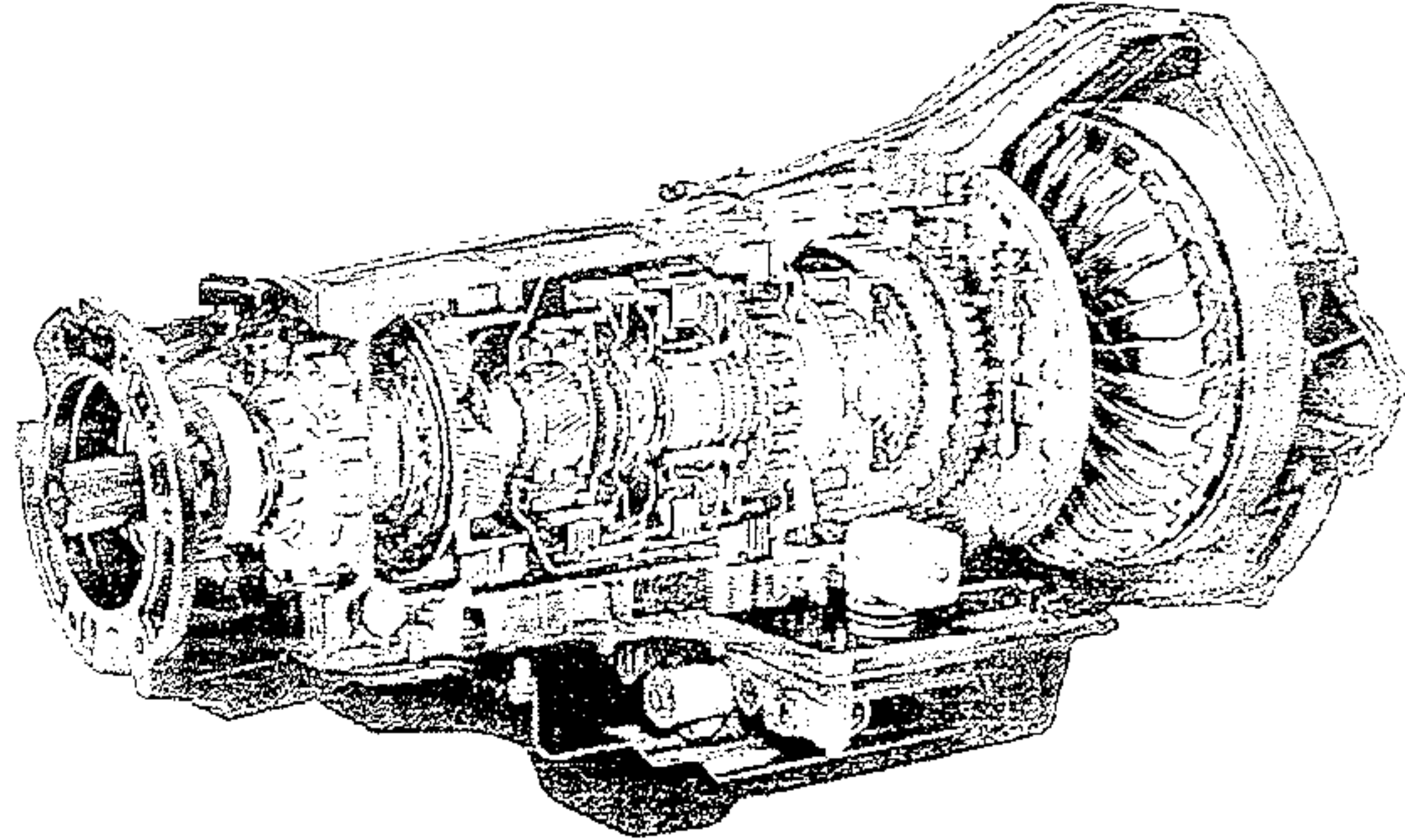

We proudly welcome all New Customers
 and Former Advanced Transmission
 Customers with a 10% Discount and Any
 Transmission Service or Repair*

865-986-9359

865-986-5050

Bad Credit, No Credit OK!!! We Finance Everybody!!!

Taxes Done Here!!! Bring your last pay stub or W2 and DRIVE TODAY!!!

Over 100 Cars, Trucks & Vans in Stock - Warranties On ALL Vehicles Sold!!!

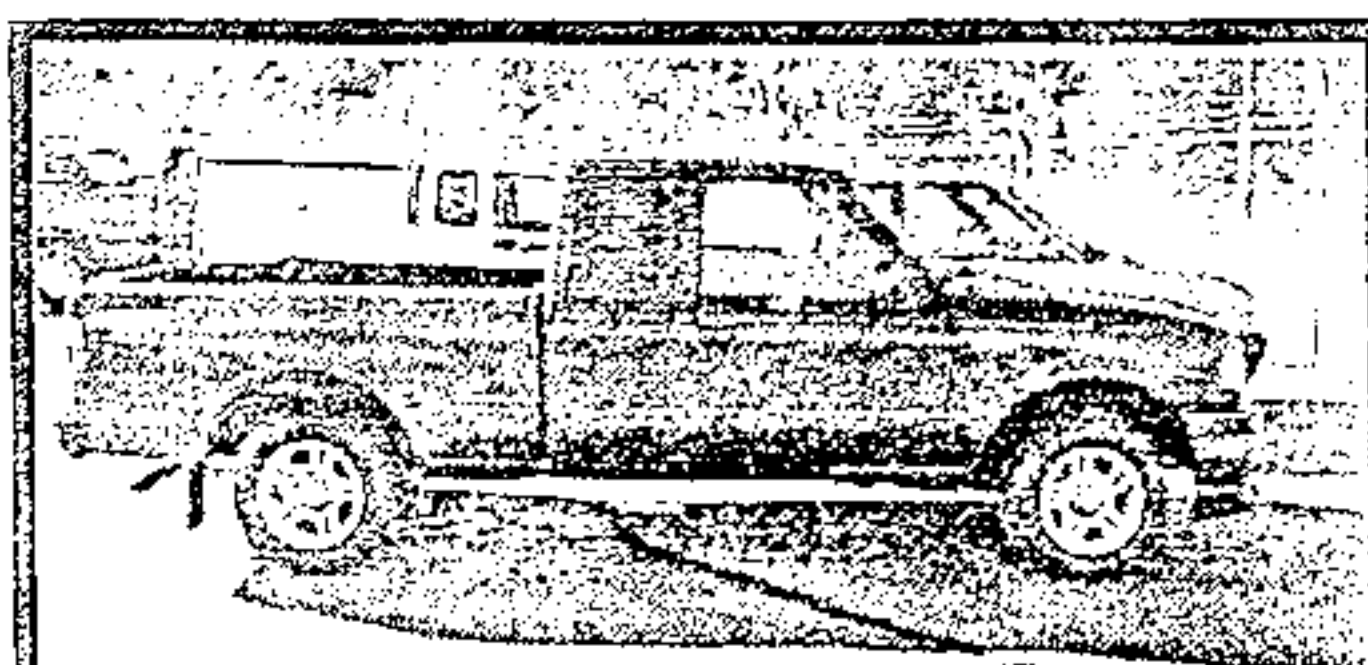

2005 Ford Ranger, Super
 Nice Truck, Very Low Miles

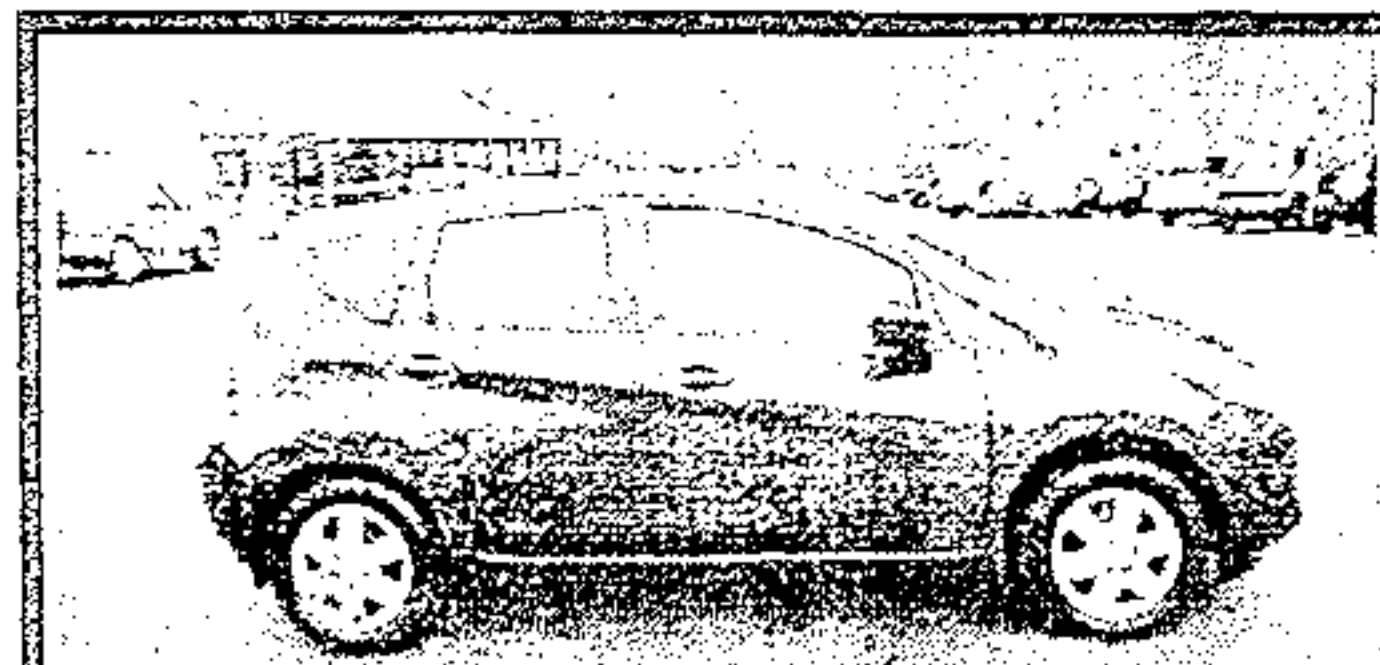

2015 Nissan Versa Note, Fac-
 tory Warranty, Low Miles

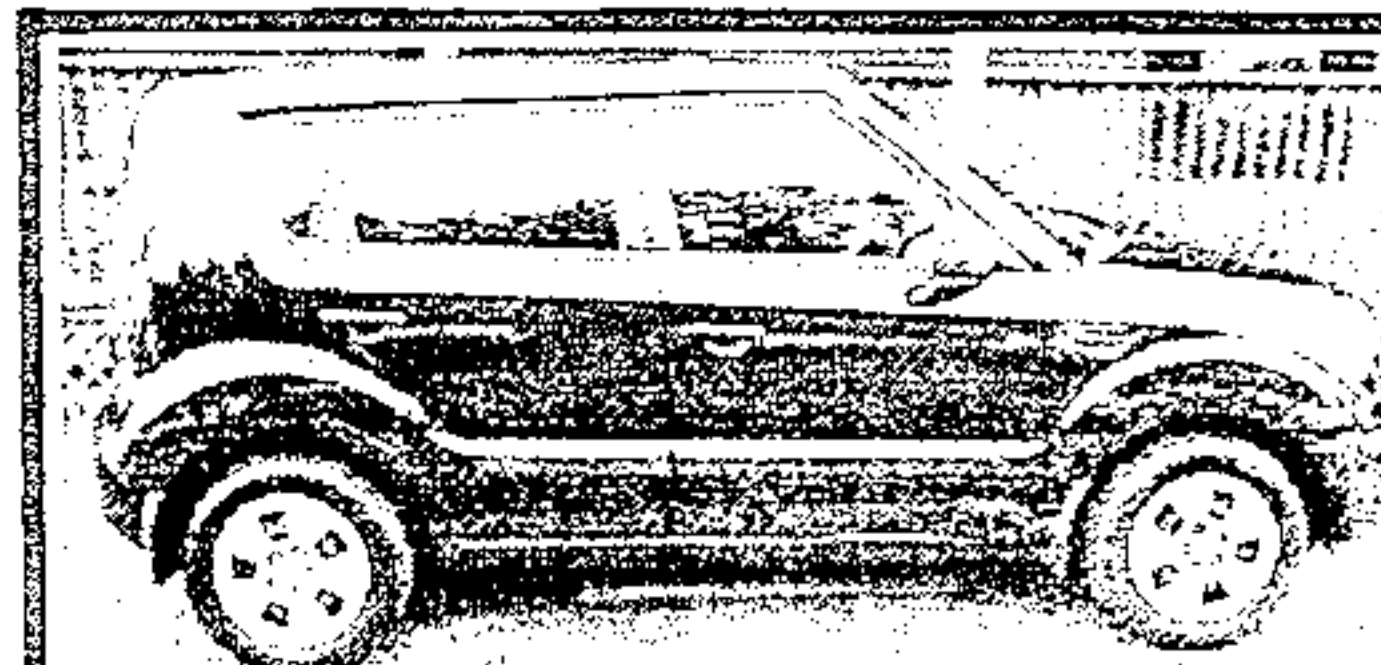

2011 Kia Soul, 5 speed, 4 dr,
 Gas Saver, Nice & Clean

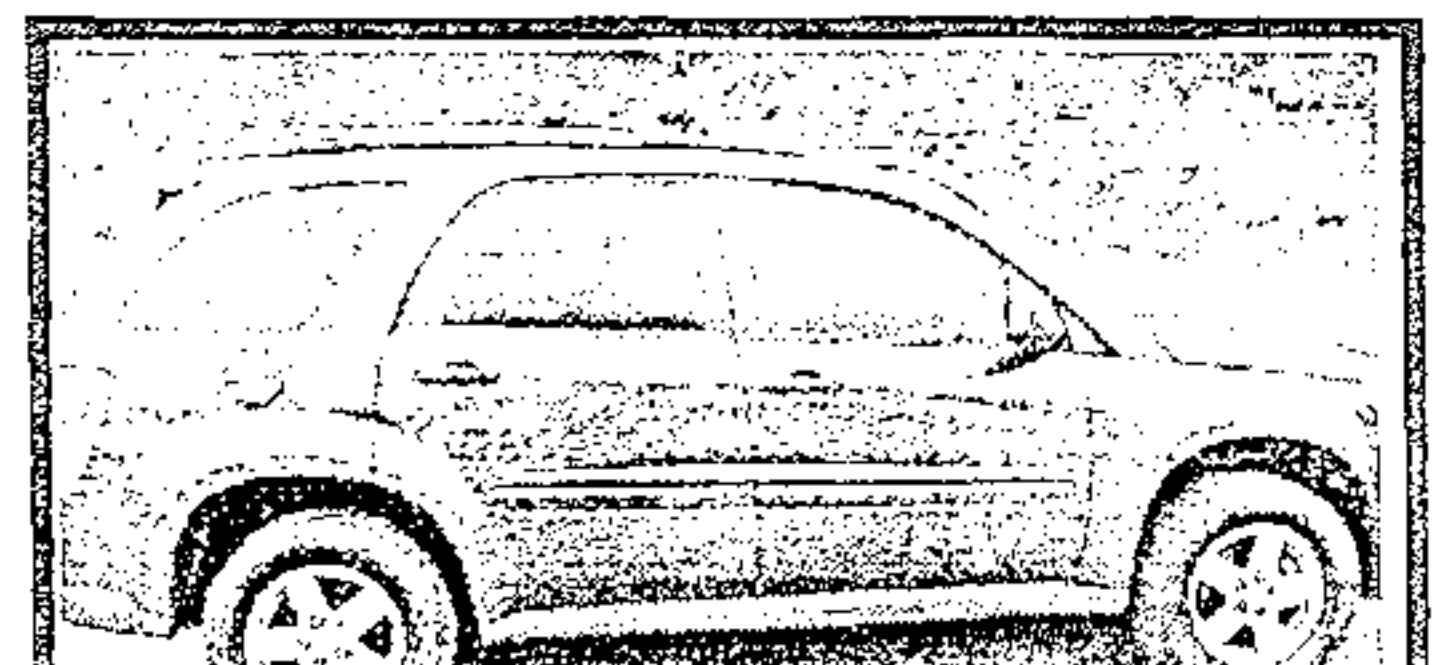

2007 Chevy Equinox, 4dr, Extra
 Clean, lots of room

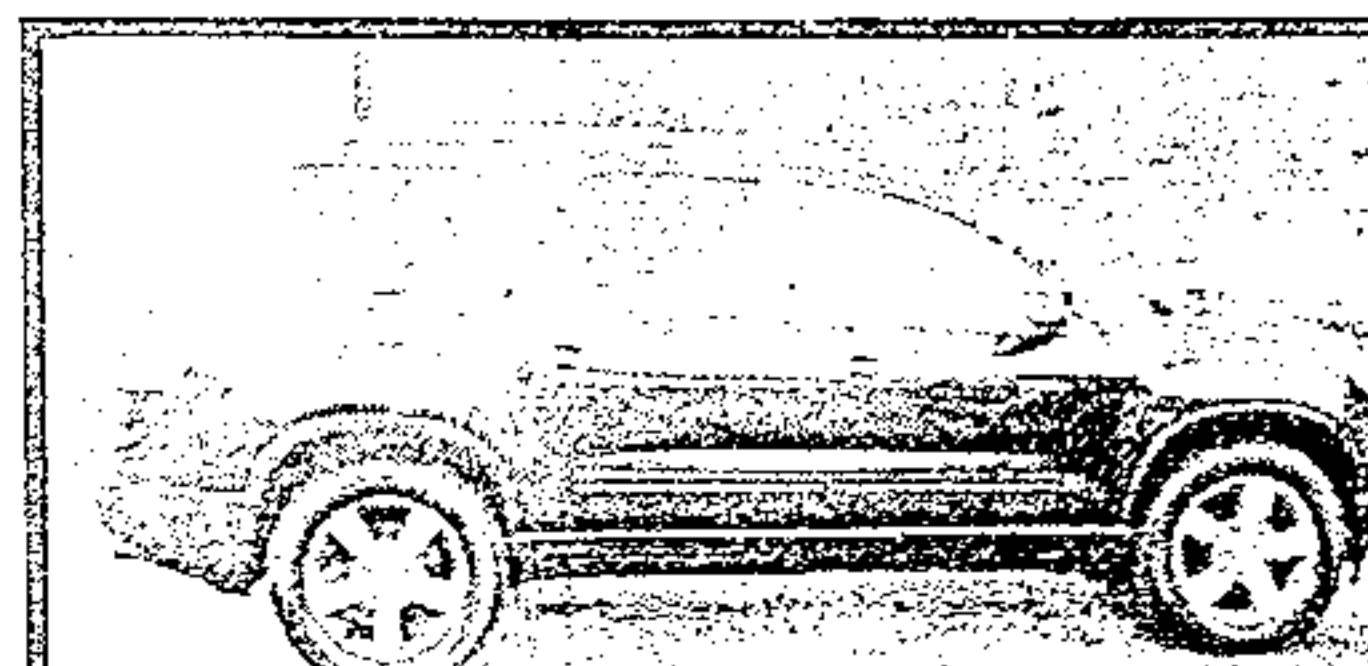

2010 GMC Acadia, Leather,
 3rd row, sunroof, Loaded

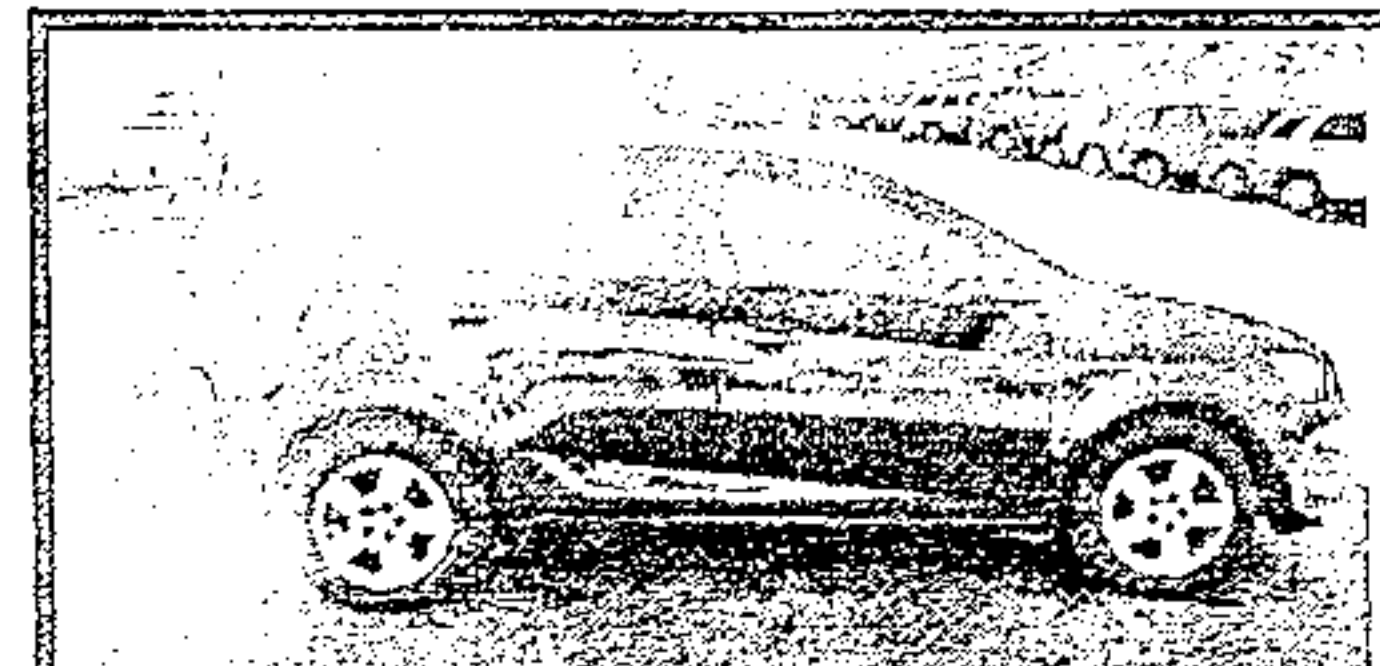

2014 Chevy Sonic, Factory
 Warranty, Low Miles!

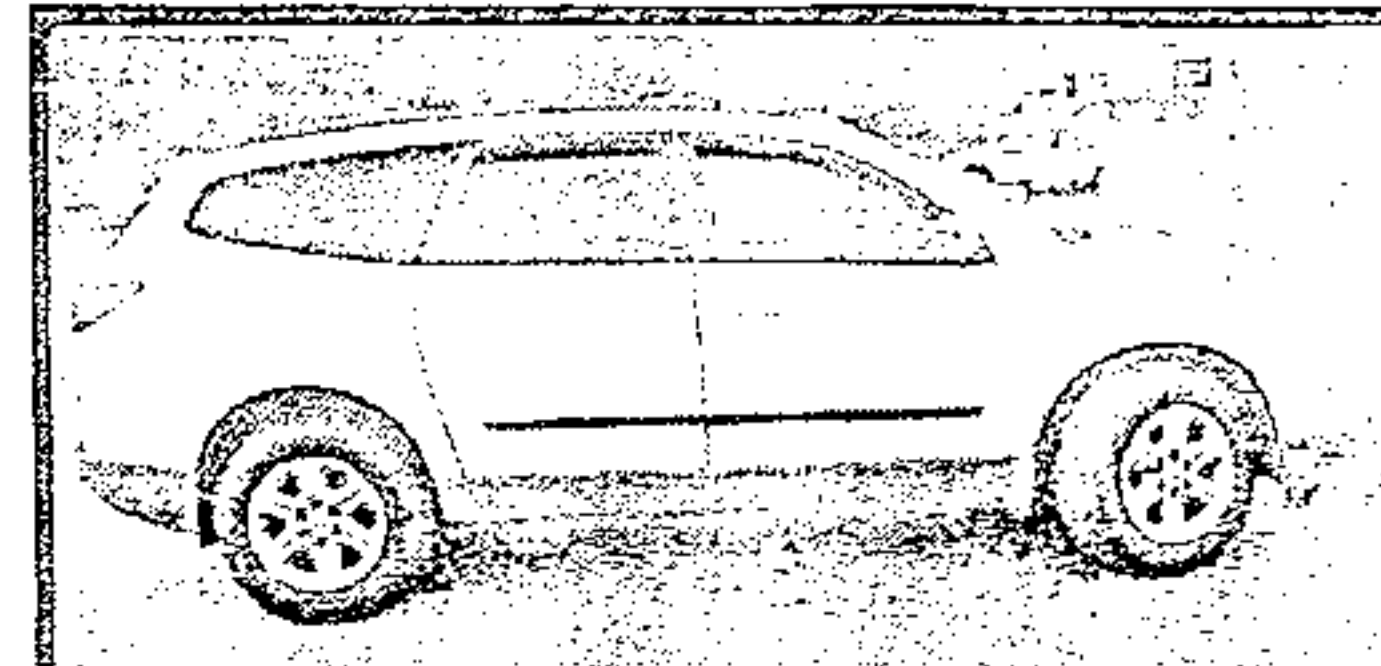

2010 Chevy Traverse, 3rd row
 seat, Loaded, Clean



2013 Nissan Versa, Like New!
 LOADED!!!

WALT WILLIAMS, INC.

*with approved credit

3003 Highway 11

Lenoir City, TN

865-986-1111