

The Daily Edition

50¢

Serving Loudon, Monroe and Surrounding Counties

Thursday, January 14, 2016

Fleeing shoplifter causes interstate shutdown; leaves infant behind

A man who fled authorities after reportedly shoplifting at Walmart was taken into custody after being boxed in on I-75. The man reportedly led authorities on a high speed chase that caused the interstate to be shut down for the safety of other driv-

(see charged pg. 7)



Dusty Qualls

You really showed up at the jail with Meth?

Obviously meth makes you SUPER STUPID!



John Lee

(see meth pg. 5)

Haslam Encourages TN Adults To "Reconnect And Complete" College Degrees

110,000 Tennesseans have already earned more than half the credit hours toward a degree

Tennessee Gov. Bill Haslam today announced "Tennessee Reconnect + Complete," a Drive to 55 initiative focused on encouraging Tennessee adults with some college credit to return to college and complete their degree.

According to the

(see TN pg. 3)

Traffic stop leads to drug bust and more

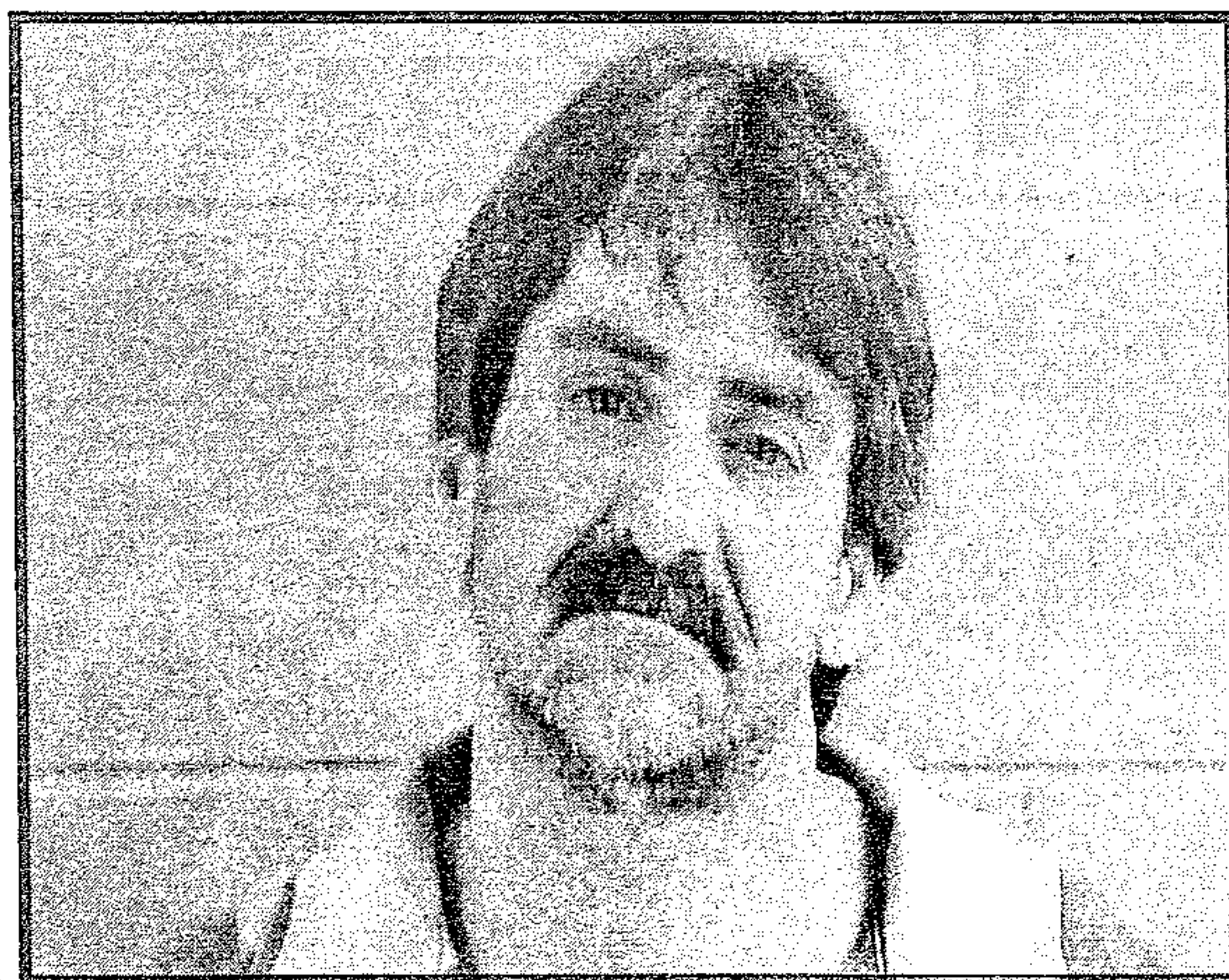

Richard Strauser

(see stop pg. 2)

Transnational Gangs Part 2: Countering the Threat with Strong Partnerships



Gang graffiti in El Salvador.

(see gangs pg. 4)

Verse of the Day

For he has rescued us from the dominion of darkness and brought us into the kingdom of the Son he loves, in whom we have redemption, the forgiveness of sins. — Colossians 1:13-14

Obituaries

see inside **Wazzup**

The Sheriff's Department Facebook page is getting a lot of views for sure. Keep up the good work!

Weather

Today: Sunny skies. High around 55F.
Tonight: Partly cloudy skies in the evening, then becoming cloudy overnight. Slight chance of a rain shower. Low 34F.
Friday Cloudy with occa-

sional showers. High 51F.
Friday night: A few showers early with overcast skies late. Low 39F.
Horoscopes
Capricorn 12/22-1/19
Living up to your end of the bargain and managing

(Continued on page 6)



stop

Richard Strauser, 47, Huffs Ferry Road Loudon, was charged with Man/Sell/Del/Resale SCH. II x2, Poss. of Drug Para., and Driving on Revoked/Suspended license. Deputy Cody Fritts LCSO, observed a silver vehicle traveling on Hwy 321, the driver not wearing a seatbelt, and the tag cover was block-

ing the view of the state and county. Upon stopping the vehicle at Hwy 321 and Adesa Pkwy, Deputy made contact with the driver identified as Richard Strauser. A check of Richard information through dispatch revealed his license were suspended. Richard was placed under arrest. After doing a inventory on the vehicle Deputy located in the console

stop ctd. pg. 7

Get Paid To Wave!
Now Hiring Wavers at Liberty Tax
 Apply in person at Liberty Tax, East Broadway Lenoir City or Hwy 321 Lenoir City. Must be dependable, and ready to work.

Notice
 Reward offered for the return of a handmade black walnut baby cradle and 700 strands of African trade beads stolen from our home. If you have any information please call 865-250-9280.

Notice: The Daily Edition does not knowingly accept fraudulent or misleading materials. The Daily Edition cannot guarantee the validity of offerings or statements contained herein. All liability for the contents of all advertising, and for any claims that may arise therefrom, is the responsibility of the advertiser or its agency. The Daily Edition reserves the right to reject, edit, or abbreviate any advertisement submitted. Advertising is accepted with the understanding that all liability for all copyright violations is the sole responsibility of the advertiser. Photographs, artwork and other copy submitted for publication is considered the sole property of the advertiser. The Daily Edition will make every effort but will not be liable for failure to publish and ad or for typographical and layout errors. All statements and information about highlights featured items, letters to the editor, herein are those solely given to the interviewer or writer and the Daily Edition assumes no responsibility of the accuracy or validity thereof. The Daily Edition will gladly reprint at no charge that part of an advertisement in which an error occurs provided a claim is made within 3 days of the first publication of the ad. Information contained in the Wazzup is received anonymously and the Daily Edition assumes no responsibility for information and reserves the right to edit or reject any and/or all submissions. The Daily Edition is a daily newspaper of general circulation in Loudon County defined under TCA 2-1-104(a)(13). The Daily Edition also serves Monroe, Knox, Anderson, Roane and Blount counties and serves 30,000 readers weekly. Send mail to PO Box 1240, Lenoir City TN 37771. 865-771-2249. email: dan1204us@yahoo.com
 The Daily Edition is Loudon County's premier public interest and paid advertising paper. The Daily Edition is produced and published daily Monday through Friday and is circulated throughout Loudon County and parts of Monroe and Knox Counties. Display advertising rates \$5.00 per column inch and quantity discounts available. Call for information on upcoming promotions and events.

HACIENDA Ayala's
Mexican Restaurant
 Market Dr. * Lenoir City (In Front of Food City)

Real Authentic Mexican Food at Affordable Prices

BEST MARGARITA

You've Tried The Rest Now Come Have The Best!!!

We Accept ALL Competitors Coupons Outside of Mexico City!

986-3553



Good Credit OK • Bad Credit OK • Bankruptcies OK • Repo OK



2010 Kia Soul Sporty, 4 cyl, Auto, PW, PL, A/C, Great On Gas, Like New



2010 Ford Escape Limited Leather, Alloy Wheels, Heat, A/C, Luggage Rack, 79K,



2007 Dodge Ram 1500 Quad Cab, Thunder Road PKG, 20 in. Wheels, Low Miles, Hemi



2008 Ford Explorer 84k, 3rd Row Seating, Luggage Rack, Tow Pkg, PW, PL



2011 Ford Ranger Low Miles, Tow Pkg, New Tires, A/C, Heat, Bed Liner.



2011 Dodge Grand Caravan DVD, Stow & Go, Loaded, Remote Doors, Rear A/C

DEPENDABLE MOTORS 986-9343
 803 E. Broadway • Lenoir City

* WAC. See Dealer for details Visit our website at: www.dependablemotorsle.com Serving Loudon County for 20 Years

TN

Tennessee Higher Education Commission (THEC), approximately 940,000 Tennessee adults have enrolled in a postsecondary institution in the state and achieved some college credit but left before

obtaining a degree or credential. Of those, nearly 110,000 Tennesseans have earned more than half the credit hours toward a degree during the past nine years, with 25,000 likely to have enough credits to graduate in only one additional semester.

“Between working full time, taking care of kids and paying the bills, going back to college can often seem like an unrealistic option for many Tennessee adults,” Haslam said. “We’ve challenged our universities, community and technical colleges to work even harder at finding new ways to assist busy adults, particularly those who left before graduating, to come back to school and achieve their dreams of getting a college degree or certificate.

“Data shows us that when

adult students re-enter higher education they do very well, so it’s crucial that we find a way to help more of them succeed. It’s not only important to them but also to our employers and to our state.”

The Tennessee Reconnect+ Complete initiative includes:

- Comprehensive training for college and university leaders on best practices to serve adult students.

- A targeted advertising and

outreach campaign to reconnect with interested adults and help them return to school. (To view examples, please see video above and click here.)

• A one-stop shop website, www.TNReconnect.gov, to assist adult students in connecting with the right college, finding financial assistance and utilizing prior learning experience to receive college

(see TN ctd. pg. 7)

For Sale: Oak Wood Mulch

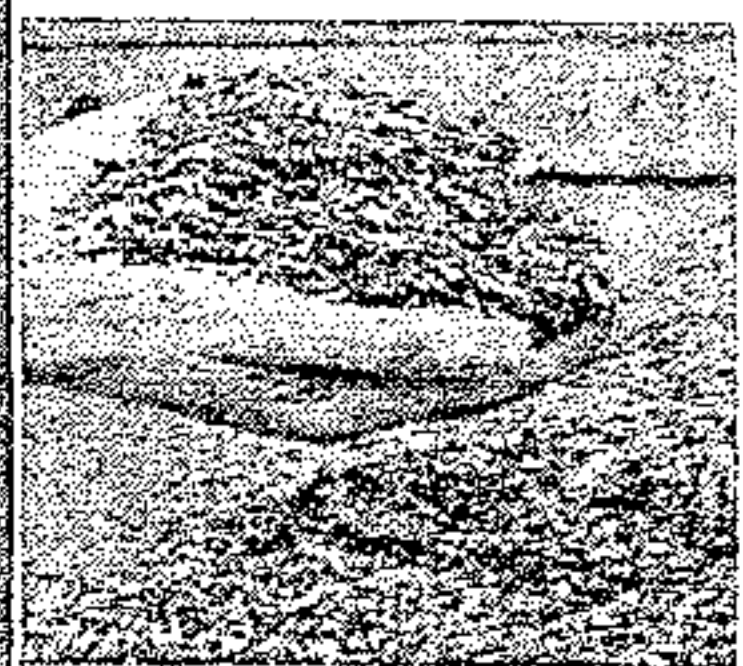

Mushroom Compost Topsoil.

Firewood



Call Steve Spoon
986-4282

West End Storage & Warehouses
502 Ward Avenue • Loudon
Call 865-458-4774 or 865-679-5555

STAINED INK

TATTOO & PIERCING

LENOIR CITY 865 816-6440

NEW OWNER • NEW ARTIST • SINCE 2011

521 Hwy 321 next to Vape & Stuff & Inn Of Lenoir!

Clean-Affordable-Quality-Custom
Tattoo's You've Always Wanted!

BRING IN THIS Ad FOR **\$25 OFF!**
NEW INK FOR NEW CUSTOMERS ONLY!

Check us out on FB.com/
Stained.Ink.Tattoo/
www.STAINEDINK.com

C&J Towing and Recovery

LOWEST TOWING RATES AROUND!!!

Have you been overcharged for any type of towing service in the Lenoir City area? If you have a breakdown or accident please OWNER REQUEST C&J Towing with the officer. Also please call your Sheriff and ask him to place C&J Towing on the “Rotation List*” and help other motorists save as much as you did! We at C&J are locally owned and operated, State approved, licensed, bonded and insured. Call and let us know if your denied service or how we can be of assistance.

*note: the “Rotation List” is a list of wrecker services that provide service for wrecks, DUI’s, breakdowns, etc. and are on an on-call basis for service. This list is approved by the Sheriff.

Cliff Teeters • Owner
865-809-1661

BIMBO'S

Deli Open 24 Hours
865-986-9643 Call Ins Welcome

Specials

Lg. Cold Sub, bag of chips and 16 oz. fountain drink
only \$6.29

Footlong Corn Dog \$2.59

gangs

At the start of the FBI's recent Central American Law Enforcement Exchange (CALEE) program, participants from U.S. police departments and their counterparts from Mexico, El Salvador, Honduras, Guatemala, Belize, and Panama were strangers, but they shared one thing in common: a commitment to make their communities safe from violent gangs such as MS-13 and 18th Street.

By the end of the three-week program, the men and women had overcome language barriers and become friends as well as partners—and they were armed with new resources to fight the transnational gang threat: a network of intelligence sharing, expanded contacts, and access to FBI-led task forces throughout Central America.

"There's a synergy between the gangs that helps them grow and become stronger," said Special Agent Jason Kaplan, the FBI's legal attaché in El Salvador. "As law

enforcement, we need to develop that same relationship with each other, because the gangs are doing it, and if we don't we are going to fall behind."

CALEE was developed in 2009 with that spirit of collaboration and partnership in mind. This year's group of nearly 40 participants traveled to Los Angeles and Houston before spending a final week in El Salvador, where the MS-13 and 18th Street gangs have grown powerful and extremely violent. In

each venue, participants received training and information about different jurisdictions' approaches to managing their gang threat.

In El Salvador, besides getting a first-hand look at gang neighborhoods and a prison whose inmates are exclusively violent gang members, participants were briefed on the latest cases and trends within the gangs. Many MS-13 and 18th Street leaders—some of whom are incarcerated—are located in Central America

and order crimes to be committed in the United States.

CALEE participants also learned about the Transnational Anti-Gang Task Forces (TAGs), in which FBI agents are embedded with vetted Central American police officers to work cases and gather intelligence. Currently there are TAGs in El Salvador, Guatemala, and Honduras. They have been in existence for more

than five years, and they are highly successful.

"Before the Transnational Anti-Gang Task Forces were set up," Kaplan explained, "gang investigations in the United States that led to subjects in these countries often came to a dead end. There was no mechanism for us to really further those investigations." Since the TAGs were established, he said, "we now have a

(see gangs ctd. pg. 5)

How about \$50 you didn't have before?

Just come to Liberty Tax, let us do your taxes and we'll hand you \$50 cash on the spot.

119 E. Broadway Street
Downtown Hwy 11

820 Hwy 321 N

Across from Burger King



Lenoir City, TN 37771
865-986-8335

with paid tax preparation. Valid at participating locations. Cannot be combined with other offers or used toward past services. One coupon per return. Expires 2-15-15

APPLY FOR AN EASY ADVANCE AND GET MONEY FAST!

\$750 Easy Advance at Liberty Tax at No Additional Cost!

820 Hwy 321 N
Across from Burger King

119 E. Broadway Street
Downtown Hwy 11

Lenoir City, TN 37771
865-986-8335

An Easy Advance (EA) is a \$750 loan secured by your tax refund and is offered by Republic Bank & Trust Company, member FDIC, to qualifying applicants. There are no fees or interest associated with the EA. Subject to approval. Visit your Liberty office to learn more. Offer Expires 2-28-15.

BUDGET
Transmissions

Why Buy From Budget?

Free Towing From Lenoir City or Loudon County
20 Years of BBB Zero Customer Complaints Award Member
A+ Plus Rated
Huge Transmission Inventory
Best Technicians Period!!!

Call (865) 584-4391 Today!

302 S. Northshore Drive Knoxville
(865) 584-4391

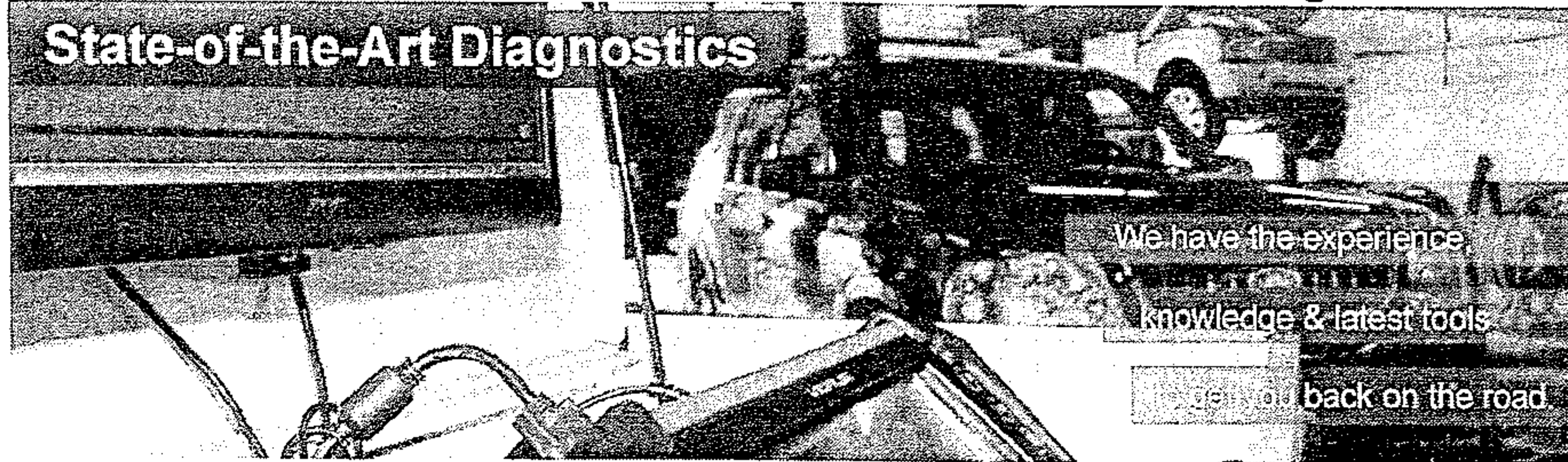
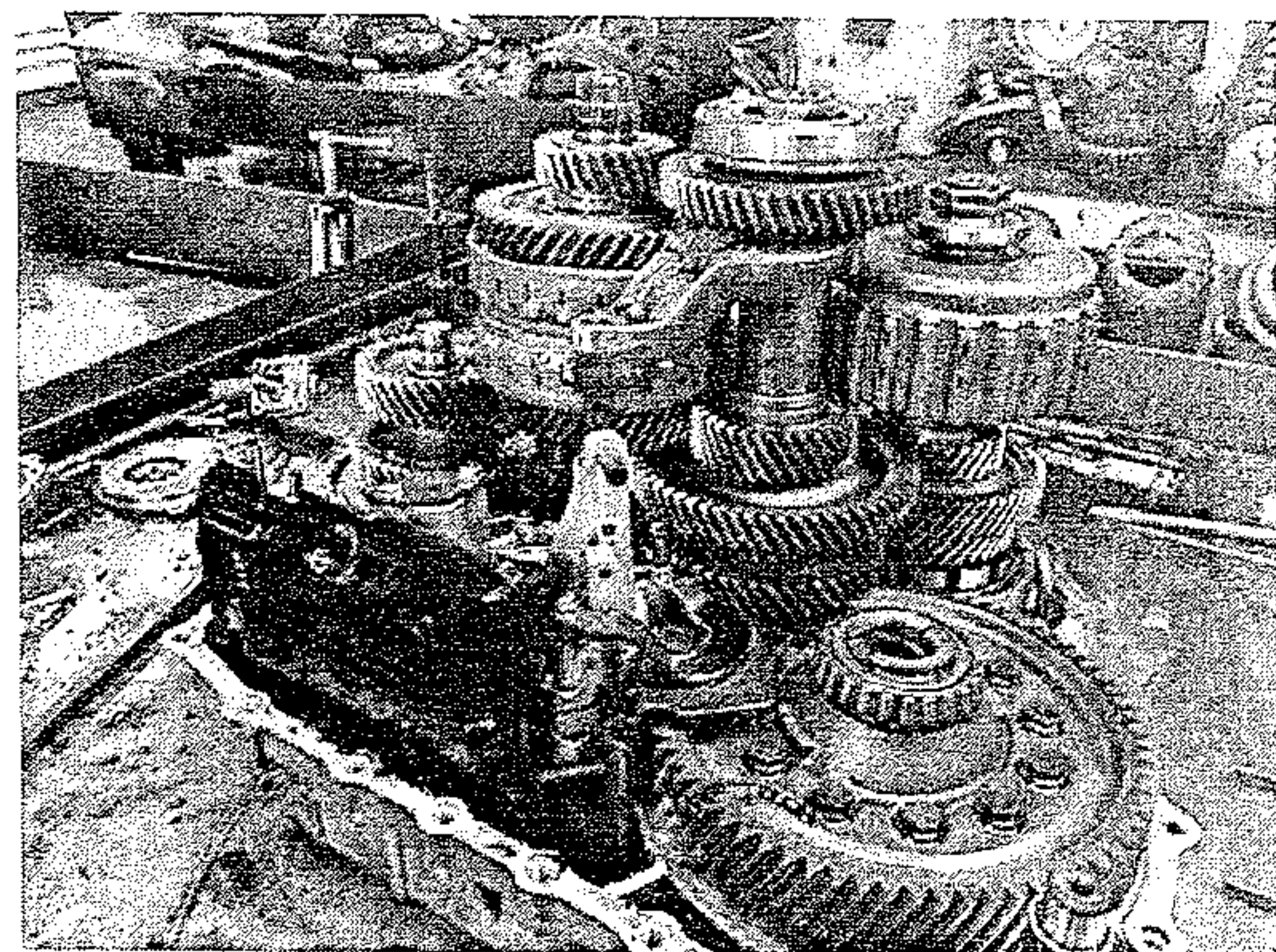

budget-transmissions.com



Approved Auto Repair



meth

John Lee, 22, Kelly Point Lenoir City, was charged with Man/Sell/Del/Resale Sch. II, and Promotion of Methamphetamine Manufacture Promotion of Meth. Deputy Chris Jenkins LCSO, and partner K9 Deja, was informed by Narcotics units of several subject possibly dropping off illegal narcotic at the Loudon jail. Deputy

made contact with the vehicle in question in the jail parking lot and identified the occupants. The rear driver side passenger was identified as John Lee. After back up Deputies ran the occupants of the vehicle through dispatch the owner was ask to search the vehicle. The driver owner did give consent. K9 Deja was deployed for a drug sniff and gave a

positive indication of a trained illegal narcotic at the driver side front door and passenger window. A search of the vehicle Deputy located in the rear passenger compartment a clear plastic bag with a clear crystal substance that tested positive for Methamphetamine weighting approx. 1 gram. The passenger in the rear driver seat was placed under arrest.

Deputy Chris Jenkins LCSO, made the arrest.

gangs ctd. from pg. 4

liaison here, a resource for investigators in the United States. When they get to that point where they realize that one of their principal subjects is located in Central America, they now have resources where they can go to further that investigation. Similarly, the countries of El Salvador, Guatemala, and Honduras can do the same.”

Kaplan added that in-

telligence gathered by the TAGs has stopped crimes—including murders—from taking place. “Dozens of lives, possibly hundreds, have been saved since the establishment of the anti-gang task forces.”

“Certainly the value of the TAGs can’t be understated,” noted Special Agent Grant Mann, who works in the Safe Streets and Gang Unit at FBI Headquarters in Washington, D.C. and helped organize this year’s CALEE program. “One of our main goals for the group in El Salvador was to fully expose participants to what the FBI has here by way of resources.”

Mann’s unit also administers the FBI’s Safe Streets Violent Crime Initiative. Established in 1992, the program is designed to bring local, state, and federal law enforcement together in their U.S. communities to fight gang-related crime. Today there are 164 Safe Streets Task Forces throughout the country, and U.S. CALEE participants are drawn from the ranks of Safe Streets Task Force officers.

“The Safe Streets model combines the strengths of all these different agencies and all of our FBI resources,” Mann said. “The goal is to make everyone’s community safer. Our efforts with the TAGs and our international partners are an extension of that goal, because there is no doubt that the gang problems in El Salvador have an impact on gang crime in the U.S.”

Speaking of the cooperative efforts between the U.S. and El Salvador to fight the MS-13 and 18th Street gangs, El Salvador’s Attorney General Luis Martinez noted, “There is something very important that both countries are aware of: that we share the same serious problem and that we have to work jointly in order to find resolutions. That is why an event like CALEE 2015 is very important,” he said. “This training will be very valuable for every single participant here.”

PURDY'S AUTO PARTS AND SALVAGE

WE BUY SCRAP IRON • COPPER • BRASS • ALUMINUM

\$ **Paying Top \$\$\$**
Call For Latest Prices

You Name It, We Buy It!

Radiators, Wheels, Batteries, Appliances, Farm Equipment

Copper
Paying Top \$\$\$
Call For Latest Prices

Complete Cars
per 100 lbs.

Scrap Metal
Paying Top \$\$\$
Call For Latest Prices
per 100 lb

We Buy Batteries

Aluminum Cans
Paying Top \$\$\$
Call For Latest Prices

You Call We Haul!

423-519-5402

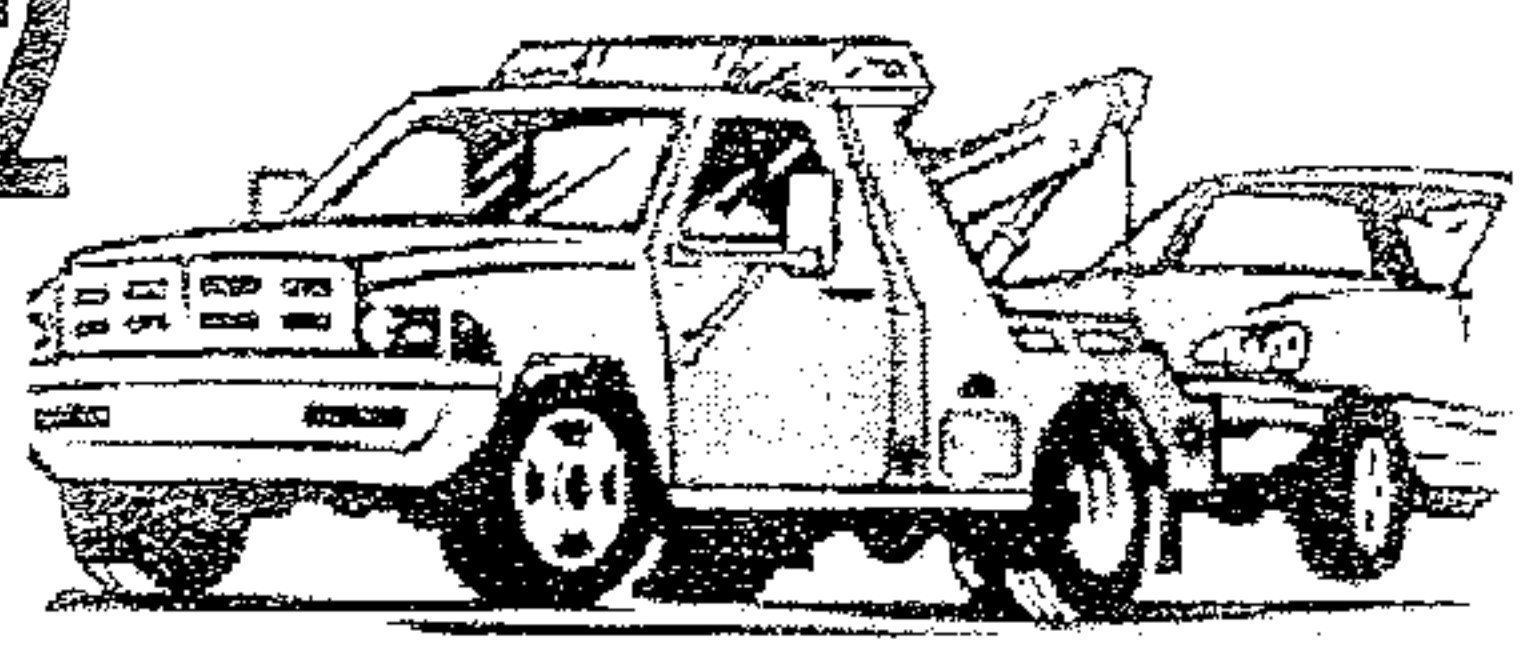

Prices subject to change with the market.

Now Selling Aftermarket Body Parts at Discount Prices

423 337-3977

149 County Road 323 Sweetwater

Prices subject to change with the market.

charged

ers until the man was taken into custody.

Dusty Qualls, 27, James Ferry Road Kingston, was charged with Evading Arrest, Reckless Endangerment x2, and Driving on Revoked/Suspended License. Deputy Brad Rayfield LCSO, was on routine patrol on Hwy 321 when E-911 gave LCPD a call at Walmart on a shop-lifter that was trying to leave the parking lot in a black vehicle and went towards the I-75. Deputy Rayfield spotted the vehicle in question and tried to get behind it with his emergency equipment

on the vehicle took off running from the Deputy on Hwy 321. The vehicle turned onto I-75 toward Monroe Co. with Deputy pursuing. Deputy Rayfield and Lt. Paul Curtis pursued the vehicle on the interstate with the vehicle refusing to stop speeds were around 75-80 mph. Other LCSO units were waiting at the exit 76. Deputy Rayfield and other units boxed the vehicle in and got the vehicle to slow to a stop close to the 75 mm. The driver identified as Dusty Qualls, leaped from the driver seat and ran across the median into the woods where he was later located and

taken into custody. Inside the vehicle was 2 passengers one being a 2 month old. Deputy Brad Rayfield LCSO, made the arrest.

stop ctd. from pg. 2

a silver canister. Inside the canister were 8 blue pills identified as Oxycodone, and 2 green pills identified as Oxymorphone, and in the glove box was a syringe. Richard did have marking on his arms from drug use. Deputy Cody Fritts LCSO, made the arrest.

TN ctd. from pg. 3

credit.

“Taking that first step to find out how to reconnect and ex-

plore their options is often the hardest part for adults, so we are working to make it as easy and accessible as possible for folks to go back and complete their degrees,” Drive to 55 Executive Director Mike Krause said.

In 2013, Governor Haslam launched the Drive to 55 to increase the number of Tennesseans with a postsecondary degree or certificate to 55 percent by 2025. As a result, the Drive to 55 has:

- Established the Tennessee Promise program, the nation's first scholarship and mentorship program that provides high school graduates last-dollar scholarships to attend two years of commu-

nity or technical college free of tuition and fees;

- Reduced the number of college freshmen requiring remediation through the SAILS (Seamless Alignment and Integrated Learning Support) program;

- Provided free technical college for adults through TCAT Reconnect Grants;

- Created Tennessee Reconnect + Complete to help more adults return to college to complete unfinished degrees;

- Developed a more comprehensive state approach to serving student veterans; and

- Leveraged technology to enhance classroom instruction and see TN conc. pg. 8

LOOK!
\$75 Weekly Payments
LOOK!

MARTY'S AUTO SALES • 986-2222
MARTY'S AUTO SALES • 986-2222
MARTY'S AUTO SALES • 986-2222
MARTY'S AUTO SALES • 986-2222
MARTY'S AUTO SALES • 986-2222

Bad Credit

Divorce

Fixed Income

Repos

Bankruptcy

No Credit

APPROVED!

Visit Us On The Web At:

martysautosales.net

NO

CREDIT

CHECKS

\$499 down*

07 Cobalt, 5spd, gas saver, runs great Only \$499 down*

\$499 down*

96 Chevy 1500, Low Miles, auto. Only \$499 down*

\$299 down*

95 Camry, auto, Gas Saver, Only \$299 down*

\$499 down*

01 Sebring 2dr. sporty, Only \$499 down*

\$299 down*

00 Civic, auto, Gas Saver, Only \$299 down*

\$399 down*

93 Ford F150, 4x4, auto Only \$399 down*

\$399 down*

03 Hyundai Elantra, Gas Saver, Only \$399 down*

\$99 down*

98 Bonneville, 6 cyl, Auto, low payments only \$99 down*

NO

Credit Checks

Marty's Auto Sales

986-2222

*See Dealer for details. All down payments plus tax, tag, title and fees.

Se Habla Espanol

100%

Approval

MARTY'S AUTO SALES • 986-2222
MARTY'S AUTO SALES • 986-2222
MARTY'S AUTO SALES • 986-2222
MARTY'S AUTO SALES • 986-2222
MARTY'S AUTO SALES • 986-2222

TN conc. from pg. 7

college advising.

Tennessee now leads the nation in FAFSA (federal student aid) completion, comprising 40 percent of the nation's total growth in 2015, and the size of the state's freshman class in higher educa-

tion grew by 10 percent in just one year. - See more at: <https://www.tn.gov/news/23359#sthash.6ZmSNTK0.dpuf>

To Advertise for as low as \$1 per day Call 865-771-2249

THE RELIC SHOP

521 Hwy 321 Lenoir City Suite 3 next to Stained Inc and the Inn of Lenoir

NOW OPEN
865-250-9280

WHERE A PERSON CAN BUY A PIECE OF HISTORY INDIAN ARTIFACTS, CIVIL WAR RELICS, FOSSILS ANTIQUE GUNS, ANTIQUE POCKETWATCHES, OLD COINS AND WHOLE LOT MORE!!!

Is Your Washer Broken?

Call Me

I Only Charge \$100 Period!!!

Call Allen

865-617-7113

A Name You Already Know And Trust Just Got Even More Dependable
DEPENDABLE AUTO SERVICE, LUBE AND TIRES
is Now Offering
Expert, Affordable Transmission Service
All ASE Certified Technicians

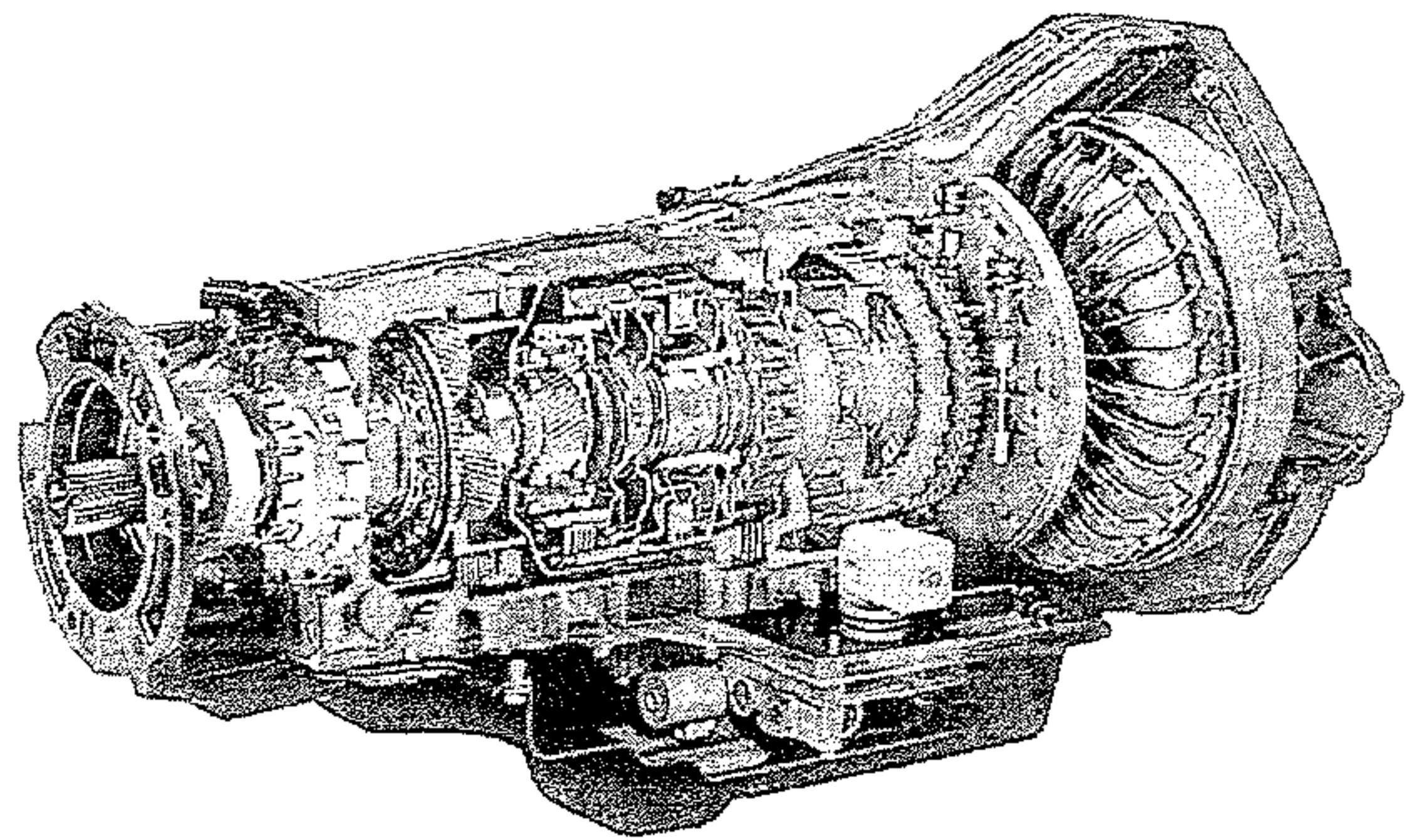

We proudly welcome all New Customers and Former Advanced Transmission Customers with a 10% Discount and Any Transmission Service or Repair*

865-986-9359

865-986-5050

Bad Credit, No Credit OK!!! We Finance Everybody!!!

Taxes Done Here!!! Bring your last pay stub or W2 and DRIVE TODAY!!!

Over 100 Cars, Trucks & Vans in Stock - Warranties On ALL Vehicles Sold!!!

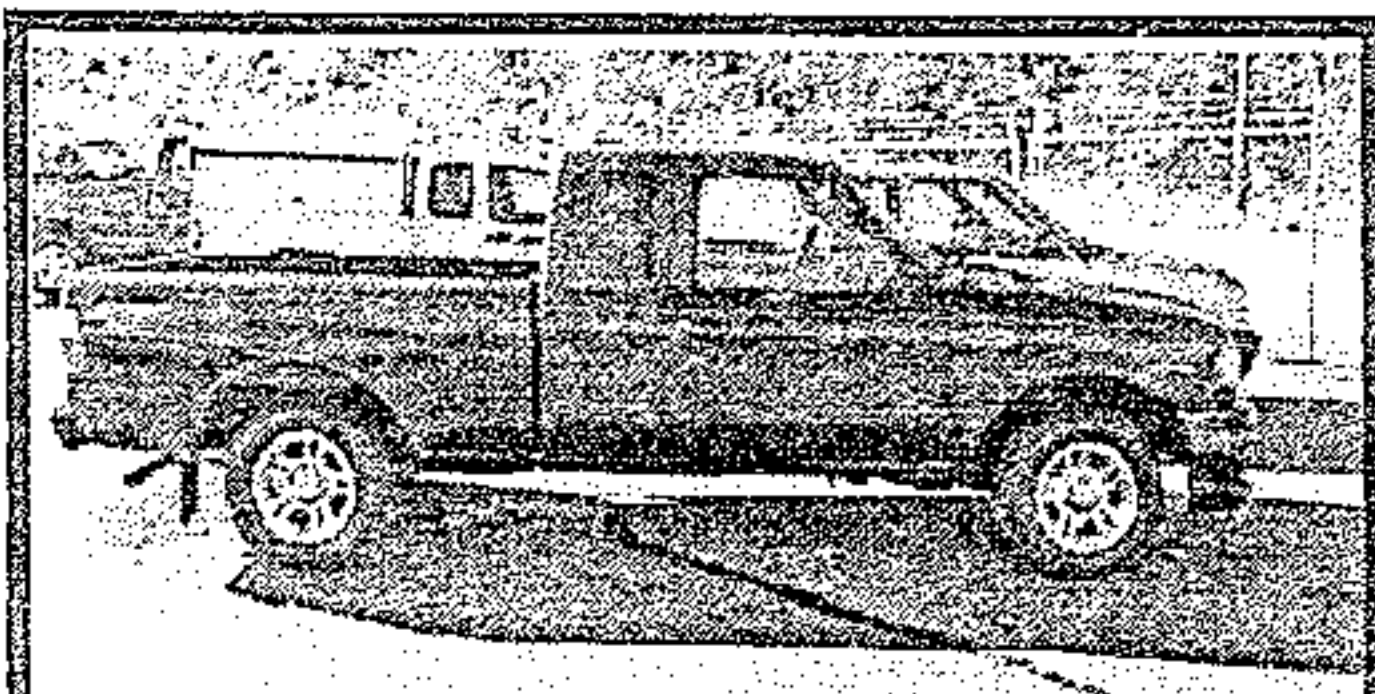

2005 Ford Ranger, Super Nice Truck, Very Low Miles

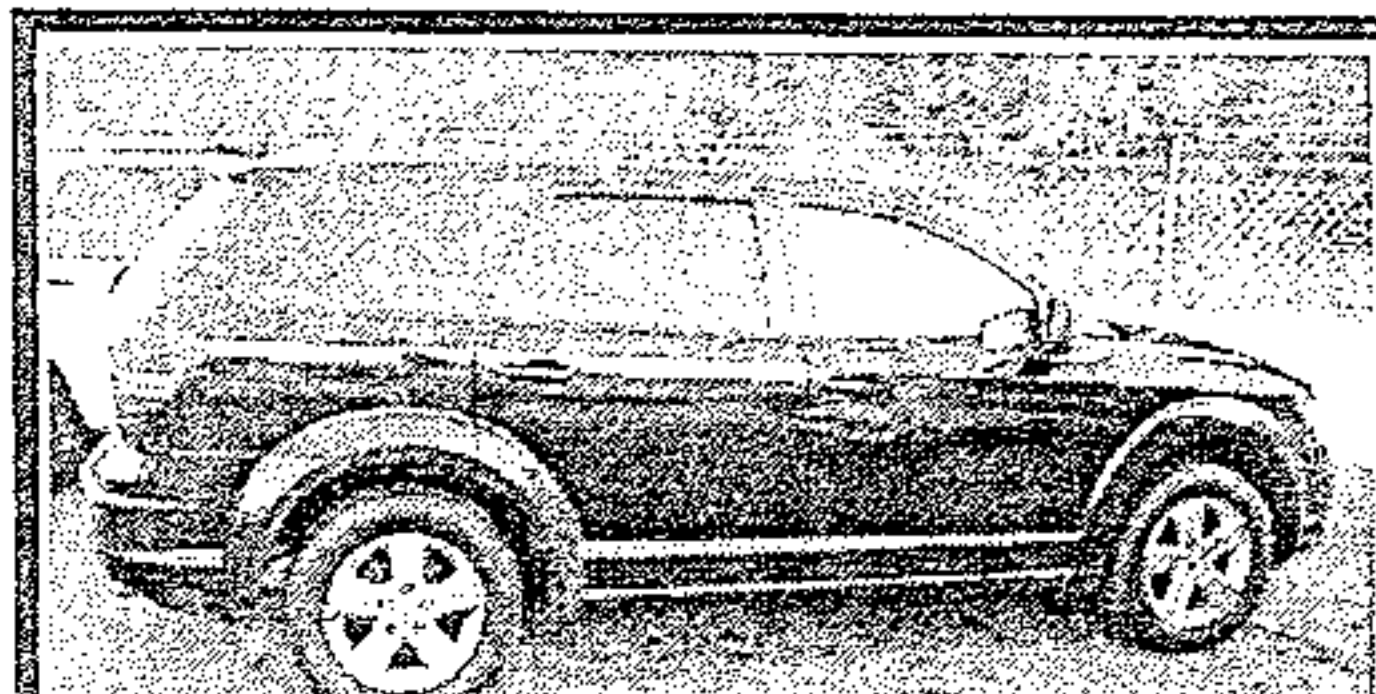

2009 Dodge Journey, 4dr, Loaded, Nice Ride

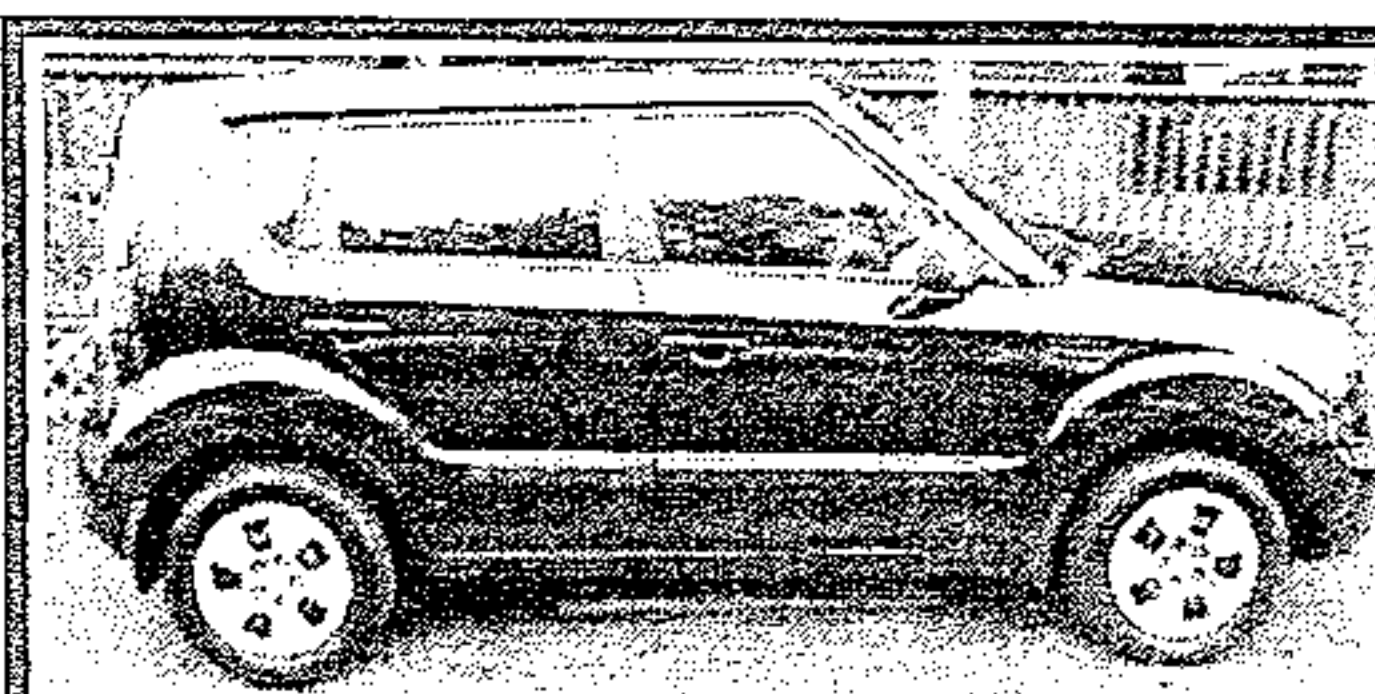

2011 Kia Soul, 5 speed, 4 dr, Gas Saver, Nice & Clean



2007 Chevy Equinox, 4dr, Extra Clean, lots of room

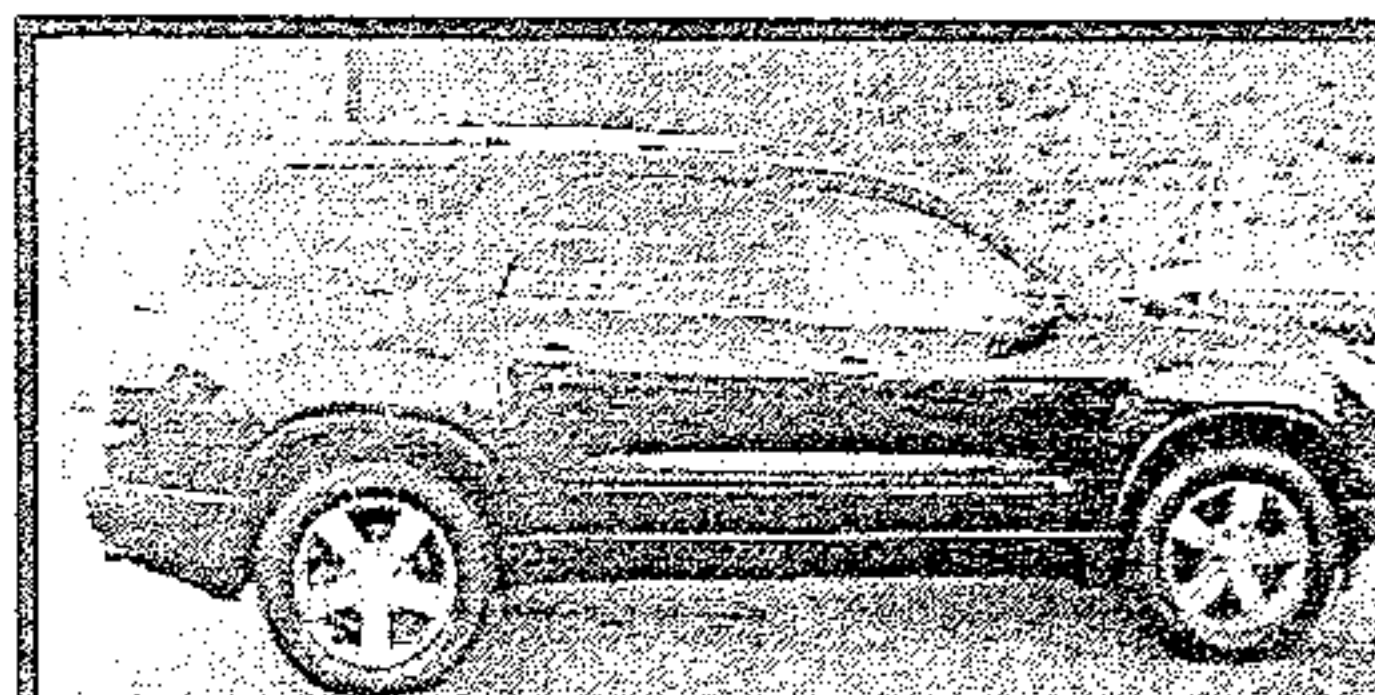

2010 GMC Acadia, Leather, 3rd row, sunroof, Loaded

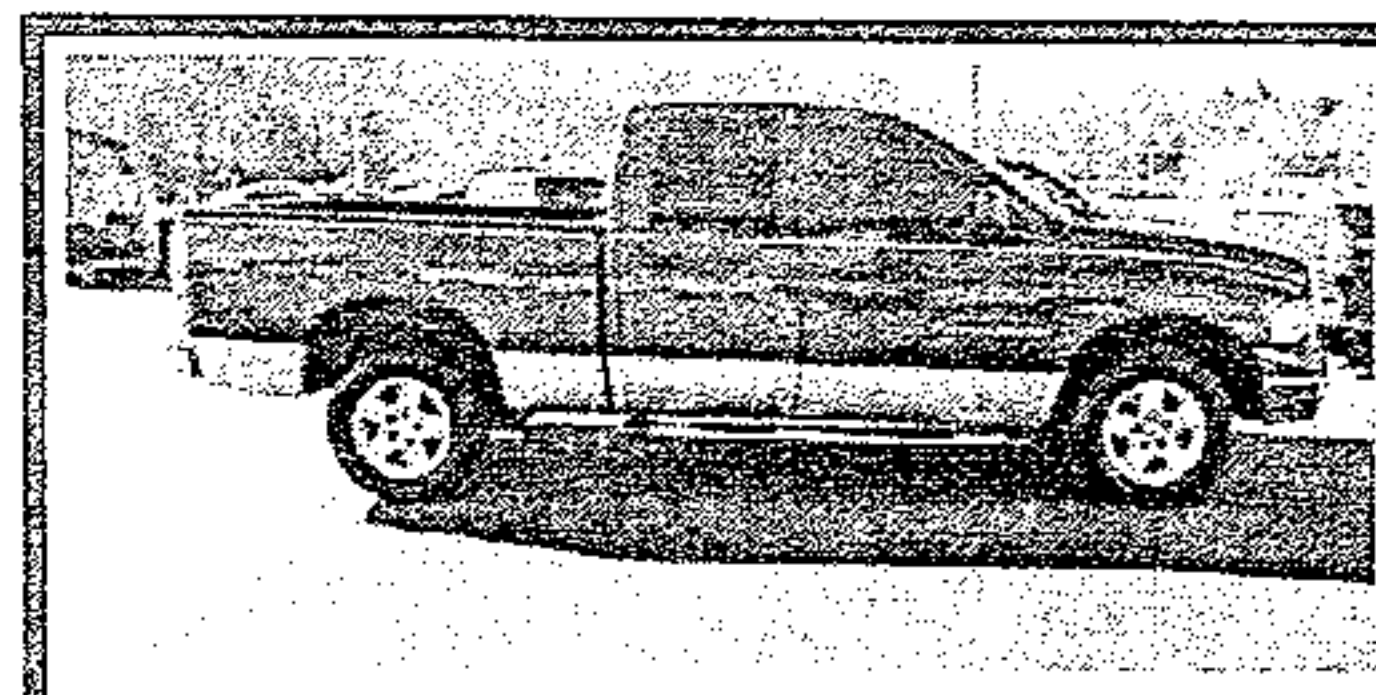

2004 Dodge Ram 1500, 4dr, 4X4, Nice Truck!!!

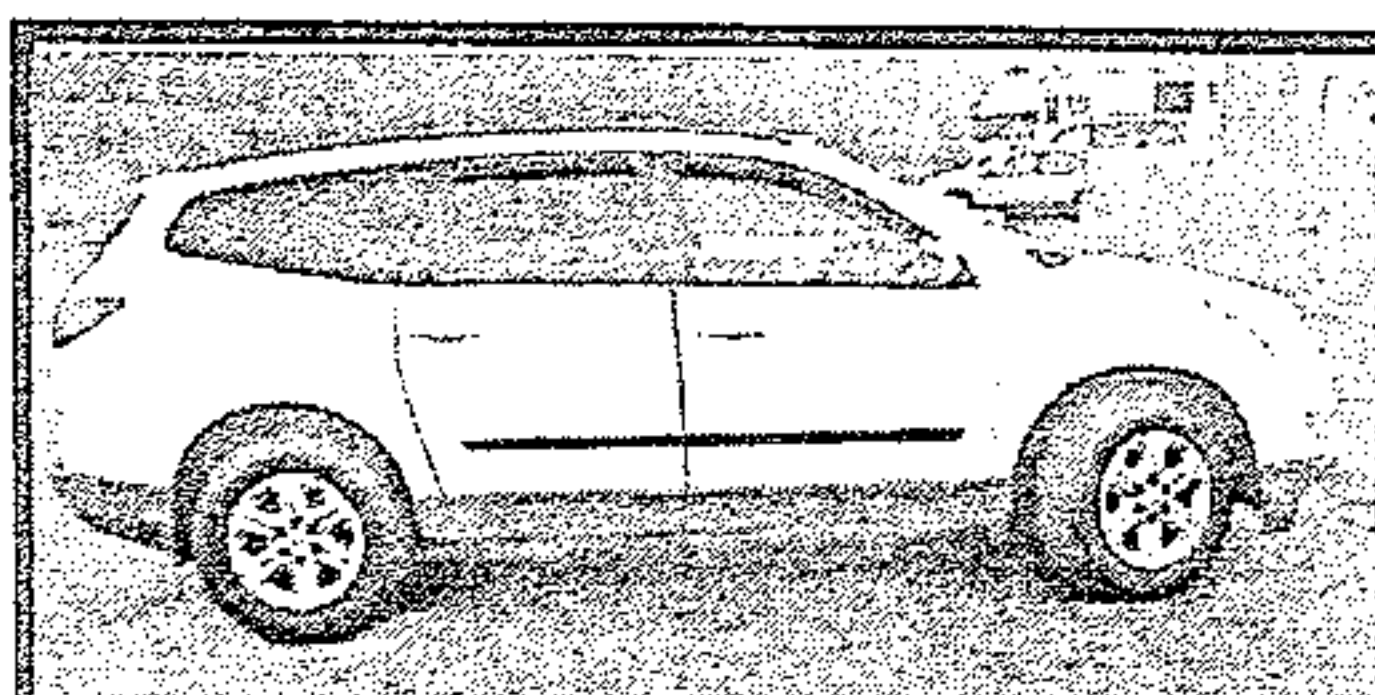

2010 Chevy Traverse, 3rd row seat, Loaded, Clean

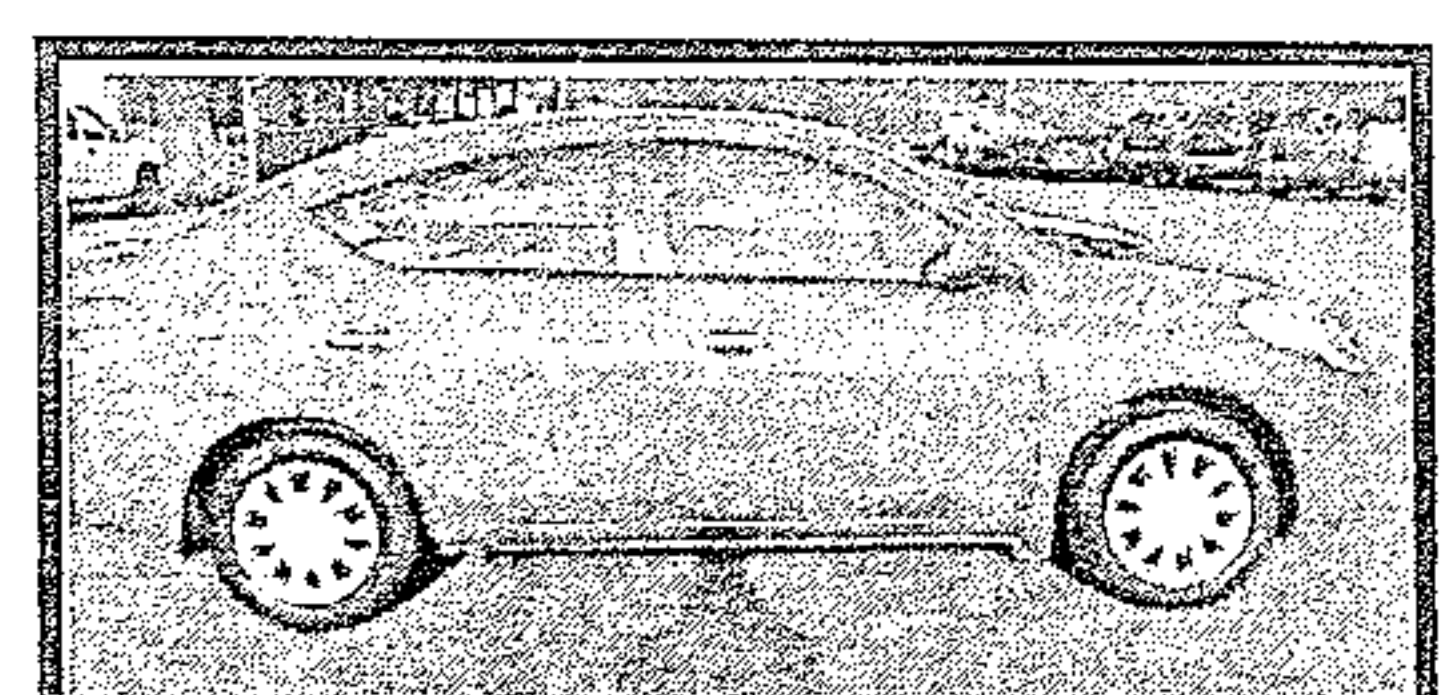

2013 Nissan Versa, Like New! LOADED!!!

WALT WILLIAMS, INC.

*with approved credit

3003 Highway 11 Lenoir City, TN 865-986-1111