

# The Daily Edition

50¢

Serving Loudon, Monroe and Surrounding Counties

Wednesday, January 13, 2016

## Jewelry and medication theft charges for local man

Tanner Wilkerson, 22, Old Midway Road Lenoir City, was charged with Theft of Property x2, Vandalism, and Contraband in a Penal Institution.

On 7 January 2016, while investigating another incident, Deputy was attempting to locate Mr. Tanner Wilk-

(see charged pg. 7)



Tanner Wilkerson

## Jacqueline Stanfill pleads guilty to fraud and money laundering charges

On Jan. 11, 2016, Jacqueline J. Stanfill, 58, of Knoxville, Tenn., pleaded guilty to wire fraud, mail fraud and money laundering, charges contained in a July 2015 federal indictment, before the Honorable Leon Jordan, Senior U.S. District Judge. A date for sentencing has not yet been set.

Stanfill faces potential sentences of: (see guilty pg. 3)

## Butt jailed by Brown Thief charged at Walmart



Christy Butt

(see thief pg. 2)

## Judge Wicks Recuses Himself in Roane County Amanda and Matthew Dotson 'baby starvation case'

In response to press inquiries the 9th District Attorney General's Office is providing the following information:

Newly appointed 9th District Criminal Court Judge announced his recusal this morning on the record during a scheduling hearing on this case that was being held in Loudon County Criminal Court.

This is the case involving the death of Clifford Dotson, the infant son of Amanda and Matthew Dotson, which case is currently set for jury trial on March 1, 2016 in Roane County. The parents of Clifford Dotson are charged by indictment with the murder of Clifford based on multiple counts including (see Wicks pg. 5)

## Law Enforcement Officers Indicted for Stealing From Nonprofit Association

A special investigation by the Tennessee Comptroller's Office has revealed that two members of the Tennessee Law Enforcement Training Officers Association (TLETOA) stole at least \$175,700 from the nonprofit association. The investigation was initiated at the request of TLETOA officials

after they discovered questionable payments from the association bank account.

The TLETOA is comprised of approximately 400 law enforcement training officers, and its primary purpose is to provide training to law enforcement personnel throughout the state. The Governor's Highway Safety Office provides the pri-

(see indicted pg. 4)

### Verse of the Day

Blessed is the man who perseveres under trial, because when he has stood the test, he will receive the crown of life that God has promised to those who love him. — James 1:12

### Obituaries

see inside **Wazzup**

A big shout out to Eddie Simpson, thanks for fixing that road out in the country, sure does make driving eas-

ier with less pot holes.

### Weather

Today: Mainly sunny. High 42F.  
Tonight: Clear skies. Low 28F.  
Thursday Sunny. High around 55F.  
Thursday Night Partly

cloudy early with increasing clouds overnight. Low 34F.

### Horoscopes

Capricorn 12/22-1/19  
Be gentle with those close to you because your loving acceptance

(Continued on page 6)





thief

Christy Butt, 40, Homeless Lenoir City, was charged with Theft of Property x2.

On 1/7/2016 the defendant was arrested for two counts of theft under \$500.

The defendant went to Walmart and obtained property with a stolen credit card. The defendant was transported from LCPD to the jail

without incident. Investigator Brad Brown LCPD, made the arrest.

### To Get a Burning Permit:

Loudon (865) 986-8395  
 Monroe (423) 442-7401  
 Roane (865) 354-1054  
 Knox (865) 215-5900

### Get Paid To Wave! Now Hiring Wavers at Liberty Tax

Apply in person at Liberty Tax, East Broadway Lenoir City or Hwy 321 Lenoir City. Must be dependable, and ready to work.

### Notice

Reward offered for the return of a handmade black walnut baby cradle and 700 strands of African trade beads stolen from our home. If you have any information please call 865-250-9280.

Notice: The Daily Edition does not knowingly accept fraudulent or misleading materials. The Daily Edition cannot guarantee the validity of offerings or statements contained herein. All liability for the contents of all advertising, and for any claims that may arise therefrom, is the responsibility of the advertiser or its agency. The Daily Edition reserves the right to reject, edit, or abbreviate any advertisement submitted. Advertising is accepted with the understanding that all liability for all copyright violations is the sole responsibility of the advertiser.

Photographs, artwork and other copy submitted for publication is considered the sole property of the advertiser. The Daily Edition will make every effort but will not be liable for failure to publish and ad or for typographical and layout errors. All statements and information about highlights featured items, letters to the editor, herein are those solely given to the interviewer or writer and the Daily Edition assumes no responsibility of the accuracy or validity thereof. The Daily Edition will gladly reprint at no charge that part of an advertisement in which an error occurs provided a claim is made within 3 days of the first publication of the ad. Information contained in the Wazzup is received anonymously and the Daily Edition assumes no responsibility for information and reserves the right to edit or reject any and/or all submissions. The Daily Edition is a daily newspaper of general circulation in Loudon County defined under TCA 2-1-104(a)(13).

The Daily Edition also serves Monroe, Knox, Anderson, Roane and Blount counties and serves 30,000 readers weekly. Send mail to PO Box 1240, Lenoir City TN 37771. 865-771-2249. email: dan1204us@yahoo.com

The Daily Edition is Loudon County's premier public interest and paid advertising paper. The Daily Edition is produced and published daily Monday through Friday and is circulated throughout Loudon County and parts of Monroe and Knox Counties. Display advertising rates \$5.00 per column inch and quantity discounts available. Call for information on upcoming promotions and events.

# HACIENDA Ayala's

## Mexican Restaurant

Market Dr. \* Lenoir City (In Front of Food City)

Real Authentic Mexican Food at Affordable Prices

**BEST MARGARITA**

You've Tried The Rest Now Come Have The Best!!!

We Accept ALL Competitors Coupons Outside of Mexico City!  
 986-3553

## Good Credit OK • Bad Credit OK • Bankruptcies OK • Repo OK



2010 Kia Soul Sporty, 4 cyl, Auto, PW, PL, A/C, Great On Gas, Like New



2010 Ford Escape Limited Leather, Alloy Wheels, Heat, A/C, Luggage Rack, 79K,



2007 Dodge Ram 1500 Quad Cab, Thunder Road PKG, 20 in. Wheels, Low Miles, Hemi



2008 Ford Explorer 84k, 3rd Row Seating, Luggage Rack, Tow Pkg, PW, PL



2011 Ford Ranger Low Miles, Tow Pkg, New Tires, A/C, Heat, Bed Liner.



2011 Dodge Grand Caravan DVD, Stow & Go, Loaded, Remote Doors, Rear A/C

# DEPENDABLE MOTORS 986-9343

803 E. Broadway • Lenoir City

Serving Loudon County for 20 Year

\* WAC. See Dealer for details

Visit our website at: [www.dependablemotorslc.com](http://www.dependablemotorslc.com)



guilty

up to 20 years in prison, a fine of up to \$250,000, and supervised release of up to three years for the wire fraud charge; up to 20 years in prison, up to a \$250,000 fine, and supervised release of up

to three years for the mail fraud charge; and up to 10 years in prison, a fine of up to \$500,000 or twice the value of the property involved in the transaction (whichever is greater) and supervised release of up to three years for the mail fraud violation. According to terms included in the plea agreement, the court will be asked to order the sentences imposed to run concurrently. Restitution to the victims of her crimes as well as forfeiture of assets gained through her illegal acts may also be ordered by the court.

Stanfill was the owner and operator of Stanfill Wealth Management in Knoxville. In the plea agreement on file with the U.S. District Court Clerk, Stanfill admits that she claimed to invest her clients' money with legitimate invest-

ment companies; however, she converted the funds to her own personal use. In order to maintain the confidence of her clients, she created phony documents that had the appearance of account statements and correspondence from Charles Schwab and Co., Inc. She further attempted to maintain the confidence of her clients by making payments either under the guise of returning invested funds

and accumulated earnings, and/or by sending funds to the Internal Revenue Service to maintain the illusion that the client's fictitious investments were tax-deferred.

The investigation, which led to the indictment of Stanfill, was conducted by the FBI and IRS. Assistant U.S. Attorneys Frank Dale and Jennifer Kolman represent the United States.

**For Sale: oak Wood Mulch**

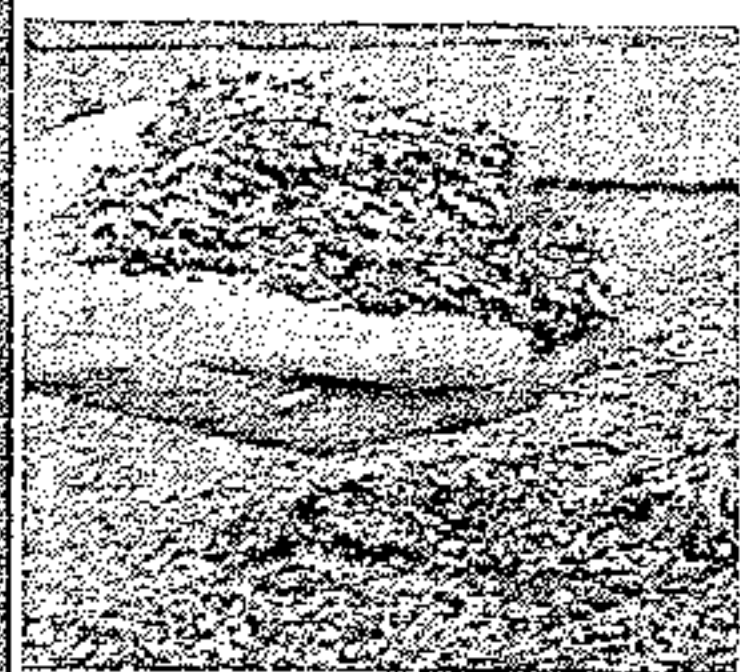

Mushroom Compost Topsoil.

Firewood

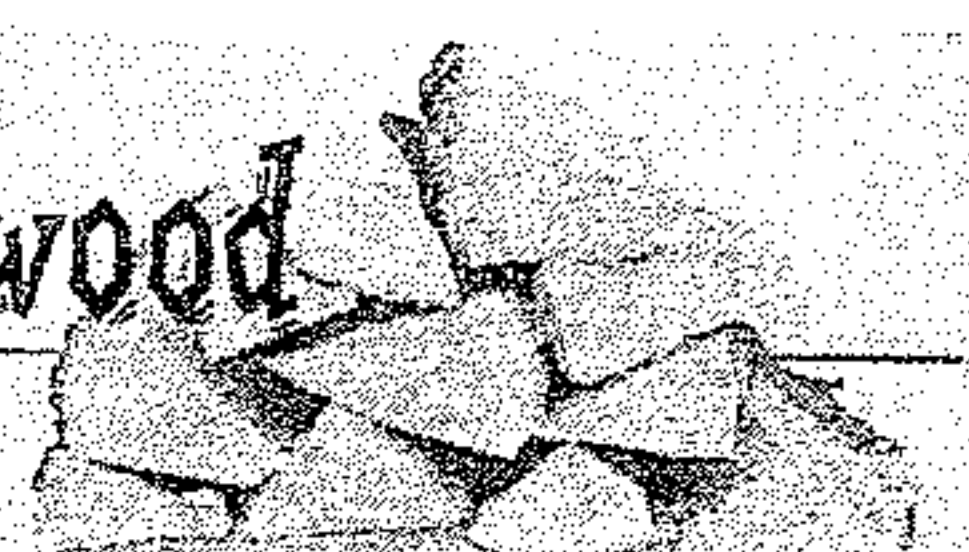

Call Steve Spoon 986-4282

**West End Storage & Warehouses**  
**502 Ward Avenue • Loudon**  
**Call 865-458-4774 or 865-679-5555**



**STAINED INK**

**TATTOO & PIERCING**

LENOIR CITY 865 816-6440

NEW OWNER • NEW ARTIST • SINCE 2011

521 Hwy 321 next to Vape & Stuff & Inn Of Lenoir!

Clean-Affordable-Quality-Custom  
 Tattoo's You've Always Wanted!

BRING IN THIS AD FOR **\$25 OFF!**  
 NEW INK FOR NEW CUSTOMERS ONLY!

Check us out on FB.com/  
 Stained.Ink.Tattoo/  
 www.STAINEDINK.com

**C&J Towing and Recovery**

**LOWEST TOWING RATES AROUND!!!**

Have you been overcharged for any type of towing service in the Lenoir City area? If you have a breakdown or accident please OWNER REQUEST C&J Towing with the officer. Also please call your Sheriff and ask him to place C&J Towing on the "Rotation List\*" and help other motorists save as much as you did! We at C&J are locally owned and operated, State approved, licensed, bonded and insured. Call and let us know if your denied service or how we can be of assistance.

\*note: the "Rotation List" is a list of wrecker services that provide service for wrecks, DUI's, breakdowns, etc. and are on an on-call basis for service. This list is approved by the Sheriff.

Cliff Teeters • Owner  
 865-809-1661

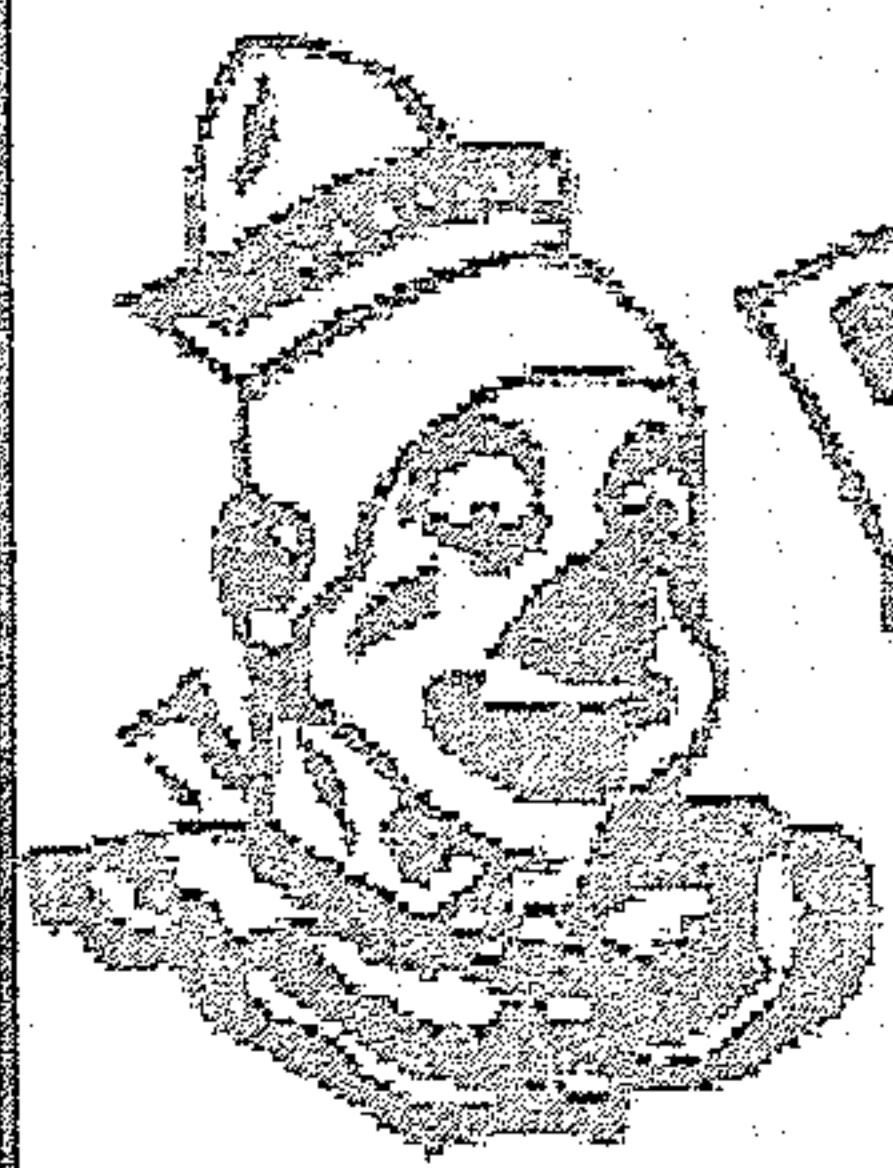
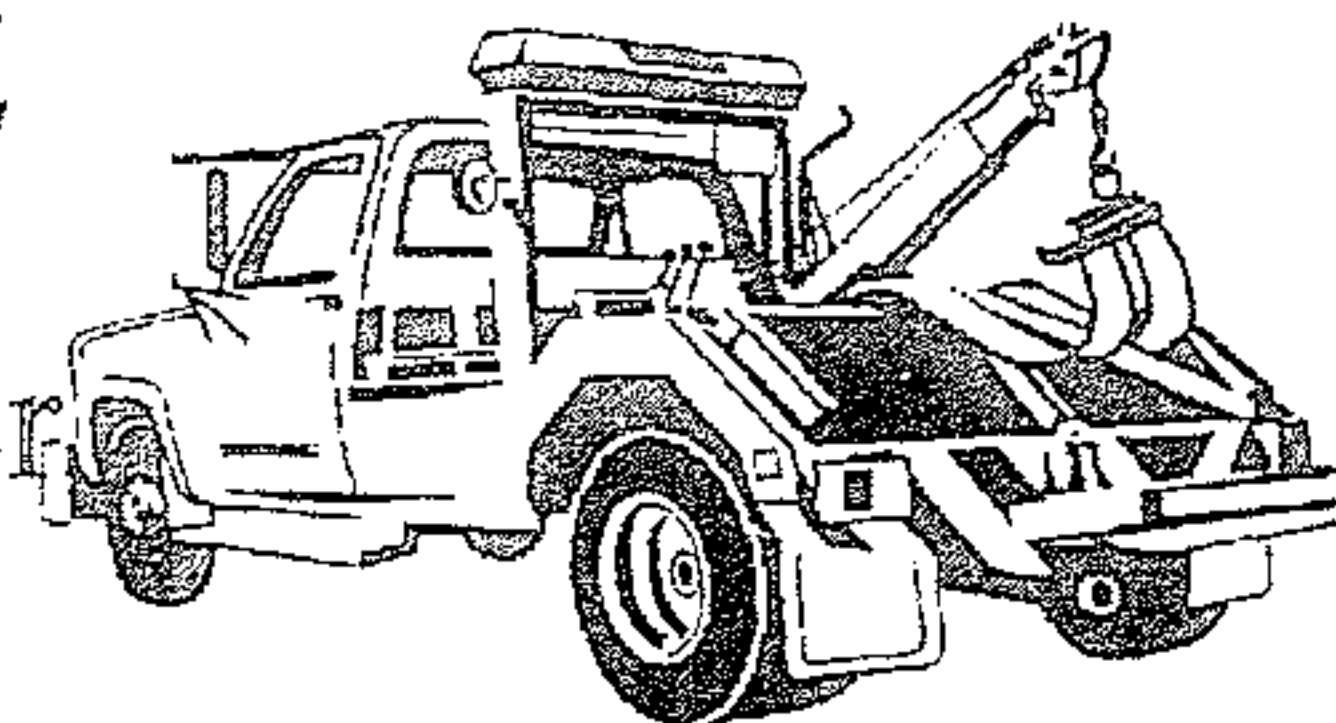

**BIMBO'S**

Deli Open 24 Hours

865-986-9643 Call Ins Welcome

Specials

Lg. Cold Sub, bag of chips and 16 oz. fountain drink  
 only \$6.29

Footlong Corn Dog \$2.59



**Indicted**

mary funding for the training conducted by TLETOA via a grant to Columbia State Community College.

Comptroller investigators found that from May 2010 to October 2013, former TLETOA treasurer Robert Hall and TLETOA project director Gary Bradley received association funds for their personal benefit.

Robert Hall issued unauthorized checks to himself totaling at least \$87,850, and Gary Bradley accepted checks that he knew were unauthorized totaling \$87,850. In 2013 alone they issued checks to themselves totaling \$103,200, which is more than 41 percent of TLETOA's total training funds.

Mr. Hall and Mr. Bradley used several

methods to conceal their unauthorized payments. These included playing signatures of two TLETOA presidents on documents to falsely indicate approval of some payments, and Mr. Hall omitted the unauthorized checks in his verbal financial reports to the board.

During this period, both men worked full

time for law enforcement agencies. Robert Hall retired from the Sparta Police Department in June 2014, and Gary Bradley is employed by the Washington County Sheriff's Office.

None of the 14 current and former TLETOA board members with whom investigators spoke recalled any board discussion or ap-

proval of the unauthorized compensation to Mr. Hall and Mr. Bradley. All expressed their shock at the amounts Mr. Hall and Mr. Bradley paid themselves.

On January 4, 2016, the White County Grand Jury indicted Robert Hall and Gary Bradley each on one count of theft over \$60,000, one count of

criminal conspiracy, and one count of forgery.

"By allowing one person, the former treasurer, to have complete control over the association's finances, this theft was able to take place over several years," Comptroller Justin P. Wilson said.

(see indicted ctd. pg. 5)

**How ABOUT \$50 YOU DIDN'T HAVE BEFORE?**

Just come to Liberty Tax, let us do your taxes and we'll hand you \$50 cash on the spot.

119 E. Broadway Street  
Downtown Hwy 11  
820 Hwy 321 N  
Across from Burger King



LIBERTY TAX SERVICE  
Lenoir City, TN 37771  
865-986-8335

with paid tax preparation. Valid at participating locations. Cannot be comined with other offers or used toward past services.  
One coupon per return. Expires 2-15-15

**APPLY FOR AN EASY ADVANCE AND GET MONEY FAST!**

**\$750 Easy Advance at Liberty Tax at No Additional Cost!**

820 Hwy 321 N      119 E. Broadway Street  
Across from Burger King      Downtown Hwy 11

**Lenoir City, TN 37771**  
**865-986-8335**

An Easy Advance (EA) is a \$750 loan secured by your tax refund and is offered by Republic Bank & Trust Company, member FDIC, to qualifying applicants. There are no fees or interest associated with the EA. Subject to approval. Visit your Liberty office to learn more. Officer Expires 2-28-15.

**BUDGET**  
*Transmissions*

**Why Buy From Budget?**

Free Towing From Lenoir City or Loudon County

20 Years of BBB Zero Customer Complaints Award Member

A+ Plus Rated

Huge Transmission Inventory  
Best Technicians Period!!!

Call (865) 584-4391 Today!

**302 S. Northshore Drive Knoxville**

**(865) 584-4391**

**State-of-the-Art Diagnostics**



We have the experience, knowledge & latest tools to get you back on the road.

[budget-transmissions.com](http://budget-transmissions.com)







**Wicks**

a Haley's Law violation in that the parents abused and/or neglected the child resulting in his death.

Judge Wicks' self-recusal was based upon his having presided over the termination of parental rights hearing in Roane County Juvenile Court involving the Dotson's older surviving son while Wicks

was Roane County General Sessions Court Judge. This termination hearing occurred after charges were brought against the Dotsons for Clifford's death. Because Wicks heard proof in the termination proceeding on the older child which evidence involved the death of Clifford, this placed him in a conflict to

serve as the trial judge during the upcoming murder case.

"Judge Wicks' self-recusal was appropriate and necessary. We expected this to happen on this case once Judge Wicks received the appointment", said 9th District Attorney General Russell Johnson. The Tennessee Administrative Office of the Courts in Nash-

ville will have to find a replacement judge to replace Judge Wicks in the upcoming trial. "It is yet unclear whether the jury trial scheduled for March 1st will have to be continued or not," Johnson said.

Amanda Dotson is represented by 9th District Public Defender Kim Nelson. Matthew Dotson is represented by Knoxville attorney Phil Lomonaco.

indicted ctd. from pg. 4 "Separating financial responsibilities between multiple individuals provides a vital control to prevent and detect theft."

To view the special investigation online, go to: <http://www.comptroller.tn.gov/ia/>.

If you suspect fraud, waste or abuse of public money in Tennessee, call the Comptroller's toll-free hotline at (800) 232-5454, or file a report online at: [www.comptroller.tn.gov/hotline](http://www.comptroller.tn.gov/hotline). Follow us on twitter: @TNCOT

**Obituaries**

Ethel Hannold Jennings age 95, of Lenoir City, TN passed away peacefully on December 25, 2015. She was of the Methodist faith. Born July 21, 1920 in Vineland, NJ, she spent most of her early years in Gifford, PA raising her family and helping her husband Carl in the Hannold Service Station. In 1959, she was an Eastern Star, past Worthy Matron, Phoenix Chapter 15, Coudersport, PA. In 1970 she married Alfred Jennings and moved to Scio, NY where she helped him with an oil lease. After his passing in 2002, she spent the last 13 years in TN. Ethel loved to make quilts, cook, work puzzles, and word finds. Preceded in death by her husbands Carl Hannold and Alfred Jennings; parents Delano & Ethel Comes; sister Beatrice Brace; brothers, Robert Comes & Marvin Comes; stepson, Edward Jennings. Survivors include daughters, Joanne Francis & Susan Young, (Edward); sons James Hannold (Rosemary) & Carl Glenn Hannold; stepson Monte Jennings; several grandchildren & great-grandchildren A memorial service will be held at 11 a.m. on Saturday, January 23, 2016 at Click Funeral Home & Cremations - Tellico Village Chapel. The family will receive friends immediately following the service. Inurnment will be held at a later date in the McKean Memorial Park in Lafayette, PA. In lieu of flowers memorials may be to: The Community Church at Tellico Village, 130 Chota Center, Loudon, Tn. 37774.

**PURDY'S AUTO PARTS AND SALVAGE**  
**WE BUY SCRAP IRON • COPPER • BRASS • ALUMINUM**

**\$** **Paying Top \$\$\$**  
**Call For Latest Prices**

*You Name It, We Buy It!*

*Radiators, Wheels, Batteries, Appliances, Farm Equipment*

**Copper**  
**Paying Top \$\$\$**  
**Call For Latest Prices**

**Complete Cars**  
**per 100 lbs.**

**Scrap Metal**  
**Paying Top \$\$\$**  
**Call For Latest Prices**  
**per 100 lb**

**We Buy Batteries**

**Aluminum Cans**  
**Paying Top \$\$\$**  
**Call For Latest Prices**

**You Call We Haul!**  
**423-519-5402**



**Now Selling**  
**Aftermarket**  
**Body Parts at**  
**Discount Prices**

Prices subject to change with the market.

**423 337-3977**  
**149 County Road 323 Sweetwater**

Prices subject to change with the market.



charged

erson at his address located at Old Midway Road in Lenoir City, Tennessee. While at this location Victim reported that Mr. Tanner Wilkerson had taken several items from her bedroom including but not limited to medication, jewelry, and approximately \$100 cash. She also stated that he took her 2006 Saturn Vue, valued at approximately \$6000.00, from the residence without her consent earlier this same date. While taking this report, the Lenoir City Police Department located the vehicle at the McDonald's on Highway

321 in Lenoir City and identified the driver of the vehicle as Mr. Tanner Wilkerson. It was also discovered during the traffic stop that Mr. Wilkerson was in possession of some of the medication belonging to victim and the cash that was reported missing by victim and then stated that the jewelry was at a local store named A and M Sports located on Broadway in Lenoir City. This above incident did occur in Loudon County, Tennessee. Deputy Bobby Hamilton LCSO, made the arrest.

On 01/07/2016, at approximately 2100 hours, Deputy Chance Gray was advised

by Deputy Eric Curtis that he had been given information by Trustee that Inmate Tanner Wilkerson had been trying to trade a clear plastic bag with a white substance for cigarette. Deputy Gray, along with Deputies E Curtis and Jamie Farr then went to the booking room of the jail to make entry into holding cell six where Mr. Wilkerson was being housed. While walking past the window of the cell Deputy noticed that Mr. Wilkerson had a white powdery substance in a line in the window sill of the cell. Deputy then made entry into the cell and removed Mr. Wilk-

erson from the cell. Deputy then escorted Mr. Wilkerson to the pat down area of the jail and performed a pat down search finding no further contraband. While patting Mr. Wilkerson down he stated that it was just Neurontin. Deputy then escorted Mr. Wilkerson into the restroom and performed a non invasive search finding an empty clear plastic wrapper. Mr. Wilkerson was then placed into visit booth one while a search of Mr. Wilkerson's cell was completed. While searching Mr. Wilkerson's cell Deputy heard a loud banging coming from the visit

booth area. Myself along with Deputies J Farr and E Curtis then went to the visit booth to find Mr. Wilkerson hitting the door. Upon opening the door Deputy J Farr noticed that Mr. Wilkerson had broken the latch device on the door. Mr. Wilkerson was then removed from the booth and placed on suicide watch due to statements he had made to Deputy E Curtis. Mr. Wilkerson did knowingly possess Neurontin a legend drug while present in a penal institution where prisoners are quartered or under custodial supervision without the ex-

see charged conc. pg. 8

**LOOK!**
\$75 Weekly Payments
**LOOK!**

MARTY'S AUTO SALES • 986-2222
MARTY'S AUTO SALES • 986-2222
MARTY'S AUTO SALES • 986-2222
MARTY'S AUTO SALES • 986-2222
MARTY'S AUTO SALES • 986-2222

Bad Credit

Divorce

Fixed Income

Repos

Bankruptcy

No Credit

# APPROVED!

Visit Us On The Web At:

[martysautosales.net](http://martysautosales.net)

NO

CREDIT

CHECKS

\$499 down\*

07 Cobalt, 5spd, gas saver, runs great Only \$499 down \*

\$499 down\*

96 Chevy 1500, Low Miles, auto, Only \$499 down\*

\$299 down\*

95 Camry, auto, Gas Saver, Only \$299 down\*

\$499 down\*

01 Sebring 2dr. sporty, Only \$499 down \*

\$299 down\*

00 Civic, auto, Gas Saver, Only \$299 down \*

\$399 down\*

93 Ford F150, 4x4, auto Only \$399 down \*

\$399 down\*

03 Hyundai Elantra, Gas Saver, Only \$399 down \*

\$99 down\*

98 Bonneville, 6 cyl, Auto, low payments only \$99 down \*

NO

Credit Checks

## Marty's Auto Sales

986-2222

Se Habla Español

100%

Approval\*

\*See Dealer for details. All down payments plus tax, tag, title and fees.

MARTY'S AUTO SALES • 986-2222
MARTY'S AUTO SALES • 986-2222
MARTY'S AUTO SALES • 986-2222
MARTY'S AUTO SALES • 986-2222
MARTY'S AUTO SALES • 986-2222



charged conc. from pg. 7  
press written consent  
of the chief adminis-  
trator of the institution.  
Mr. Wilkerson did also  
knowingly cause dam-  
age to the property of  
Loudon County know-  
ing that he did not have  
the owners effective

consent. This did occur  
at the Loudon County  
Jail, in Loudon County  
Tennessee.

To Advertise  
for as low as  
\$1 per day  
Call  
865-771-2249

## THE RELIC SHOP

521 Hwy 321 Lenoir City Suite 3  
next to Stained Inc and the Inn of Lenoir

**NOW OPEN**  
**865-250-9280**

WHERE A PERSON CAN BUY A PIECE OF HISTORY  
INDIAN ARTIFACTS, CIVIL WAR RELICS, FOSSILS  
ANTIQUA GUNS, ANTIQUA POCKETWATCHES,  
OLD COINS AND WHOLE LOT MORE!!!

### Is Your Washer Broken?

Call Me  
I Only Charge \$100 Period!!!  
Call Allen  
865-617-7113

A Name You Already Know And Trust Just Got Even More Dependable  
**DEPENDABLE AUTO SERVICE, LUBE AND TIRES**  
**is Now Offering**  
**Expert, Affordable Transmission Service**

All ASE Certified Technicians

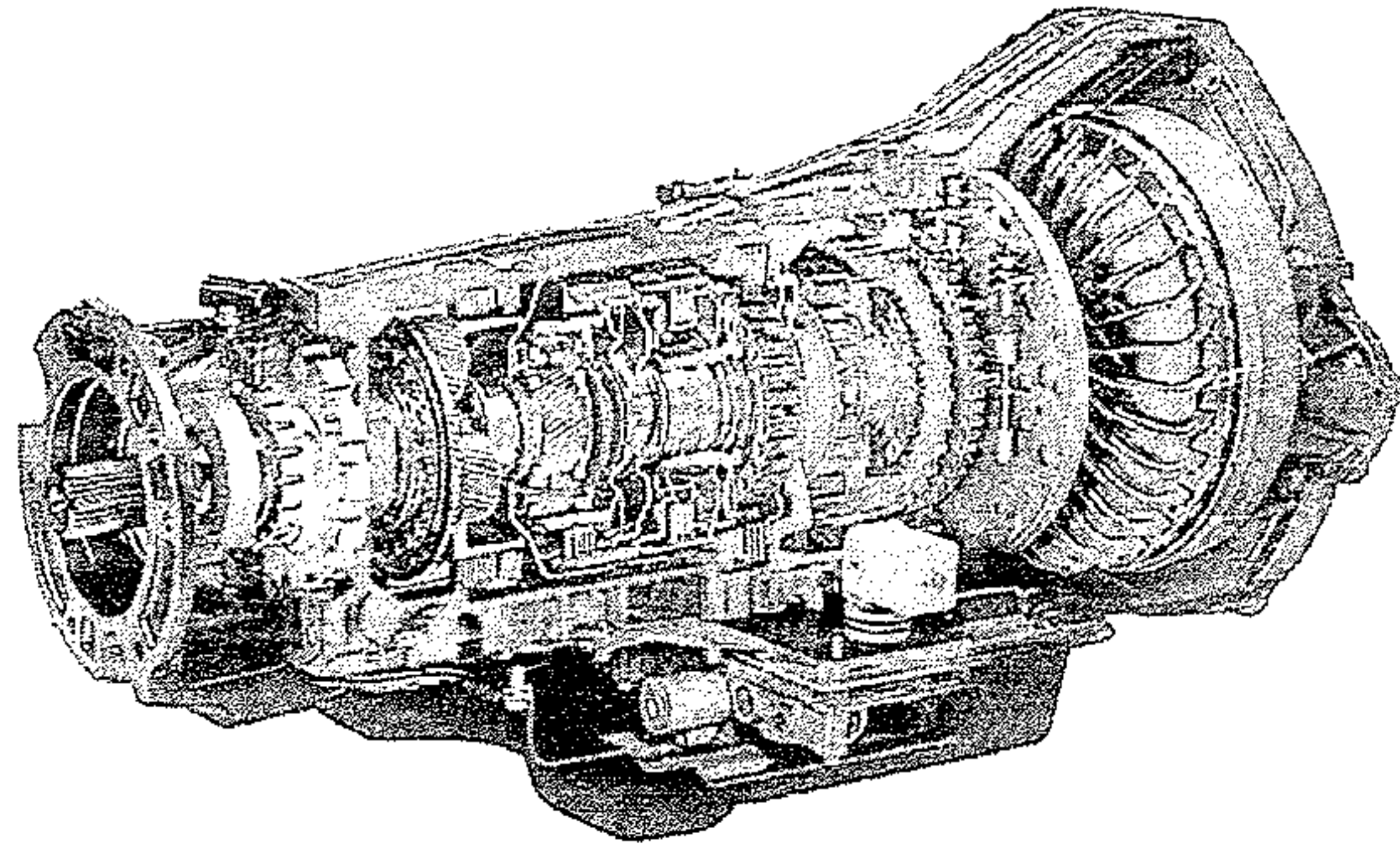

We proudly welcome all New Customers  
and Former Advanced Transmission  
Customers with a 10% Discount and Any  
Transmission Service or Repair\*

**865-986-9359**

**865-986-5050**

**Bad Credit, No Credit OK!!! We Finance Everybody!!!**

**Taxes Done Here!!! Bring your last pay stub or W2 and DRIVE TODAY!!!**

**Over 100 Cars, Trucks & Vans in Stock - Warranties On ALL Vehicles Sold!!!**

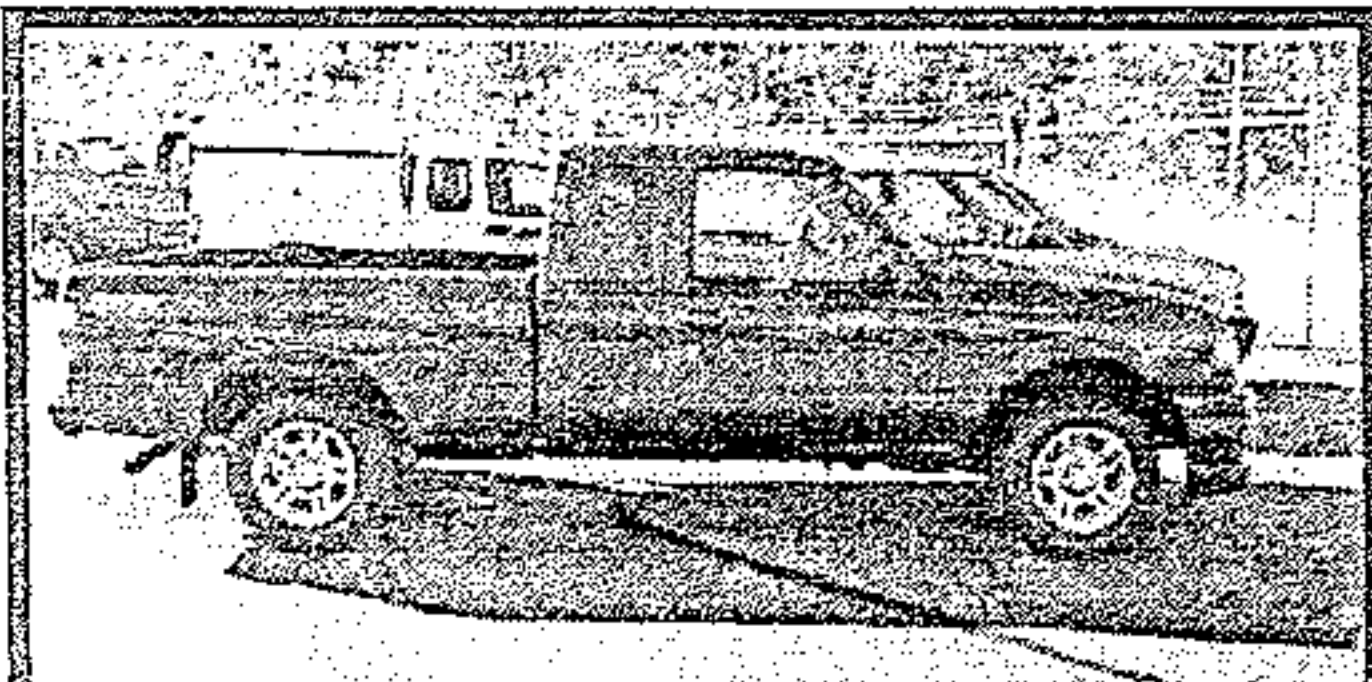

2005 Ford Ranger, Super  
Nice Truck, Very Low Miles

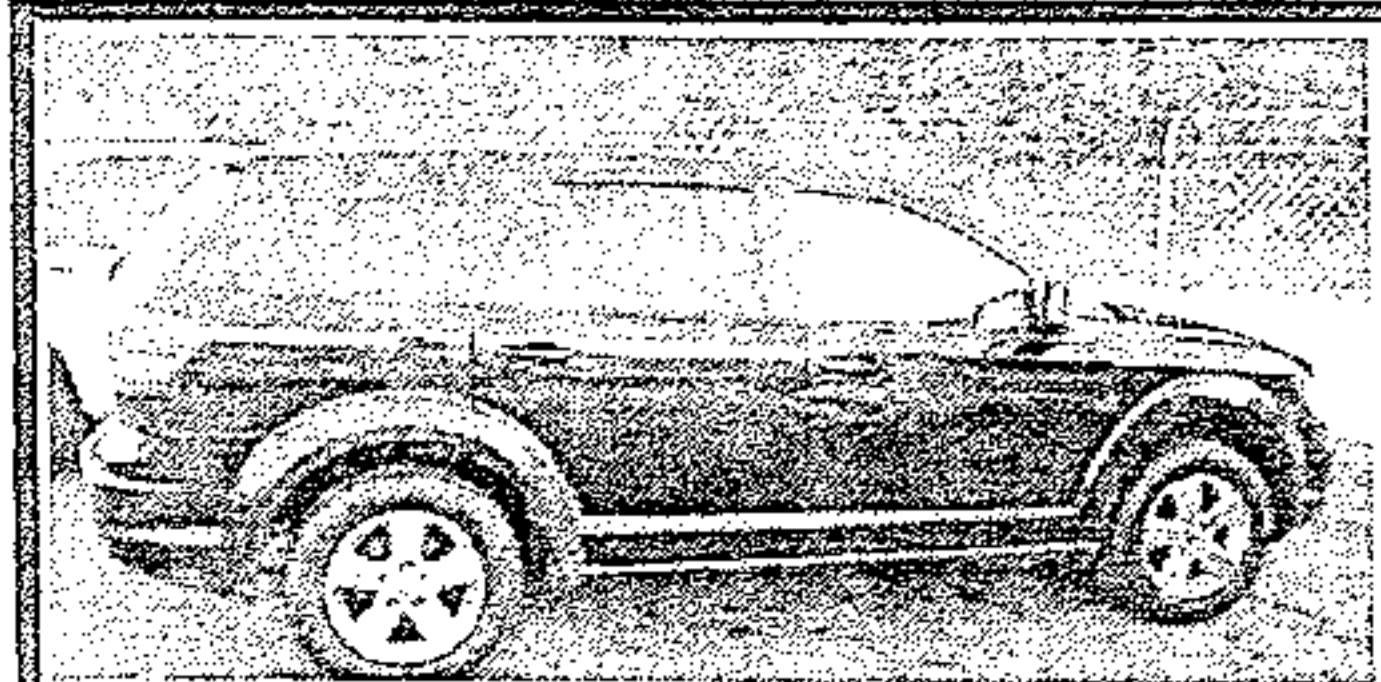

2009 Dodge Journey, 4dr,  
Loaded, Nice Ride

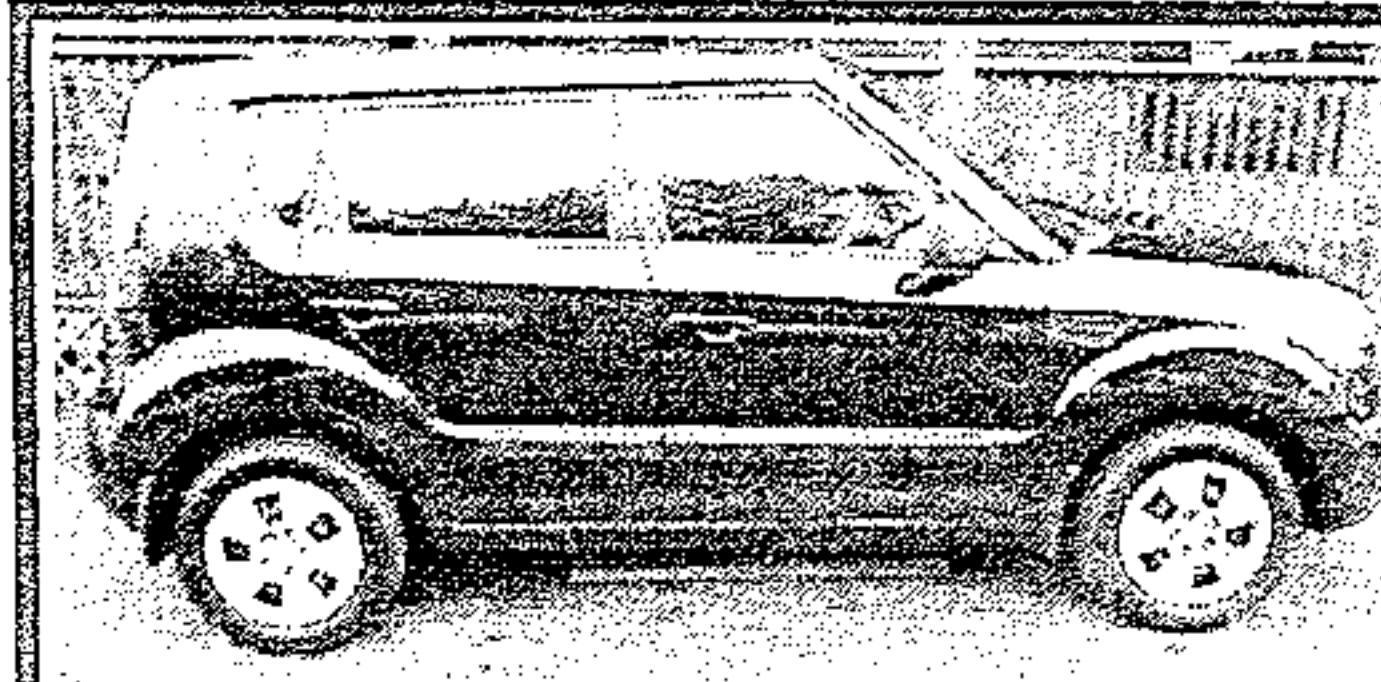

2011 Kia Soul, 5 speed, 4 dr,  
Gas Saver, Nice & Clean

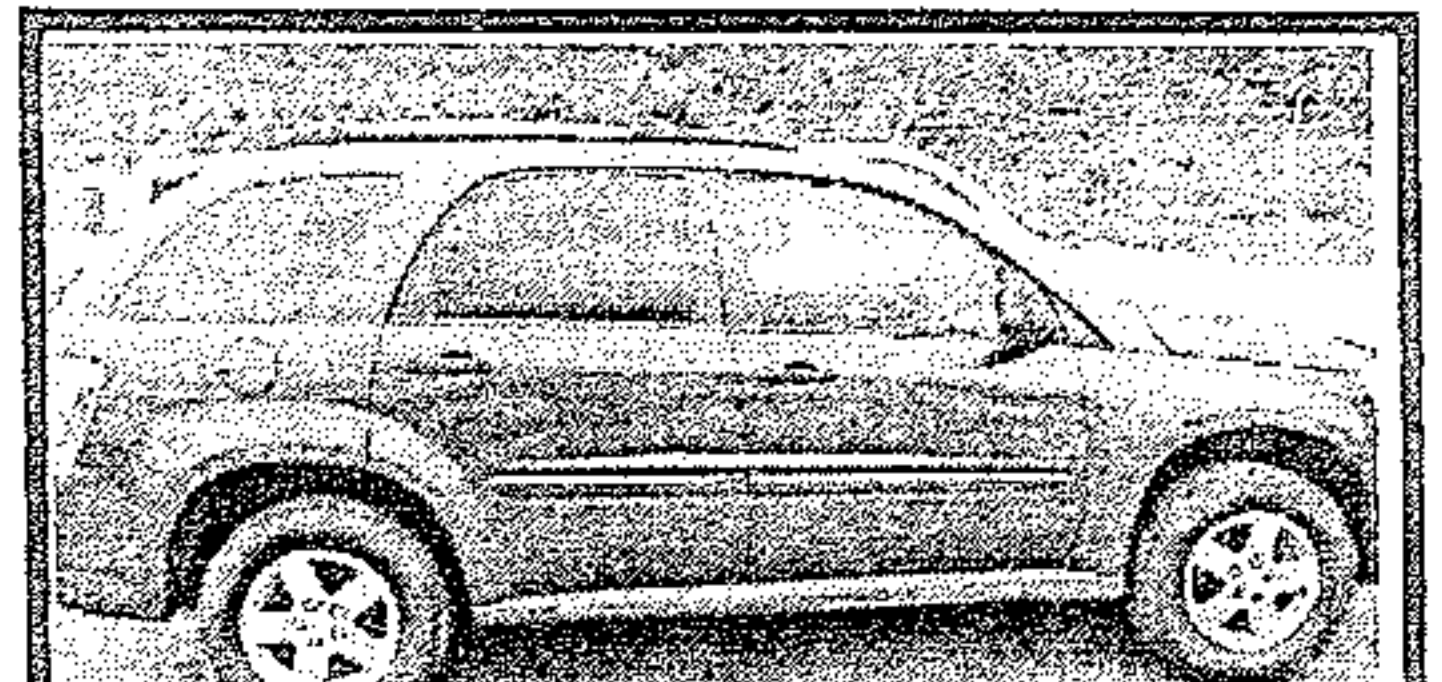

2007 Chevy Equinox, 4dr, Extra  
Clean, lots of room

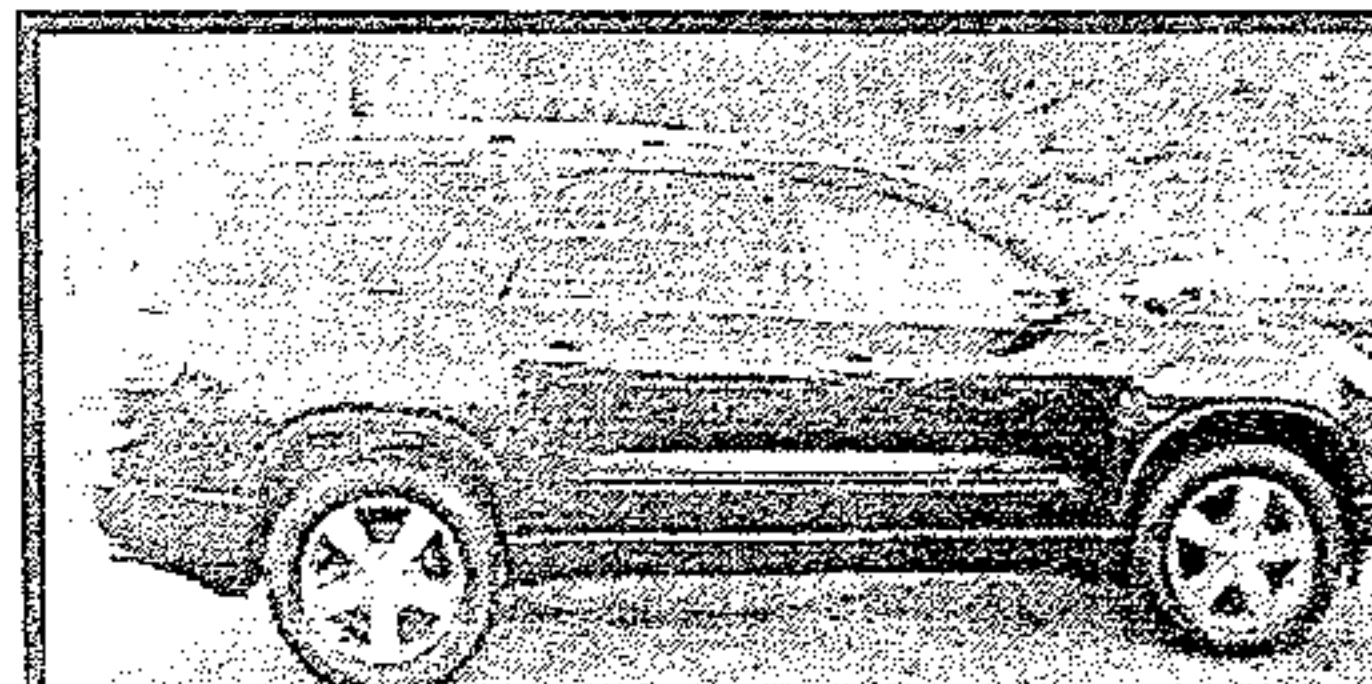

2010 GMC Acadia, Leather,  
3rd row, sunroof, Loaded

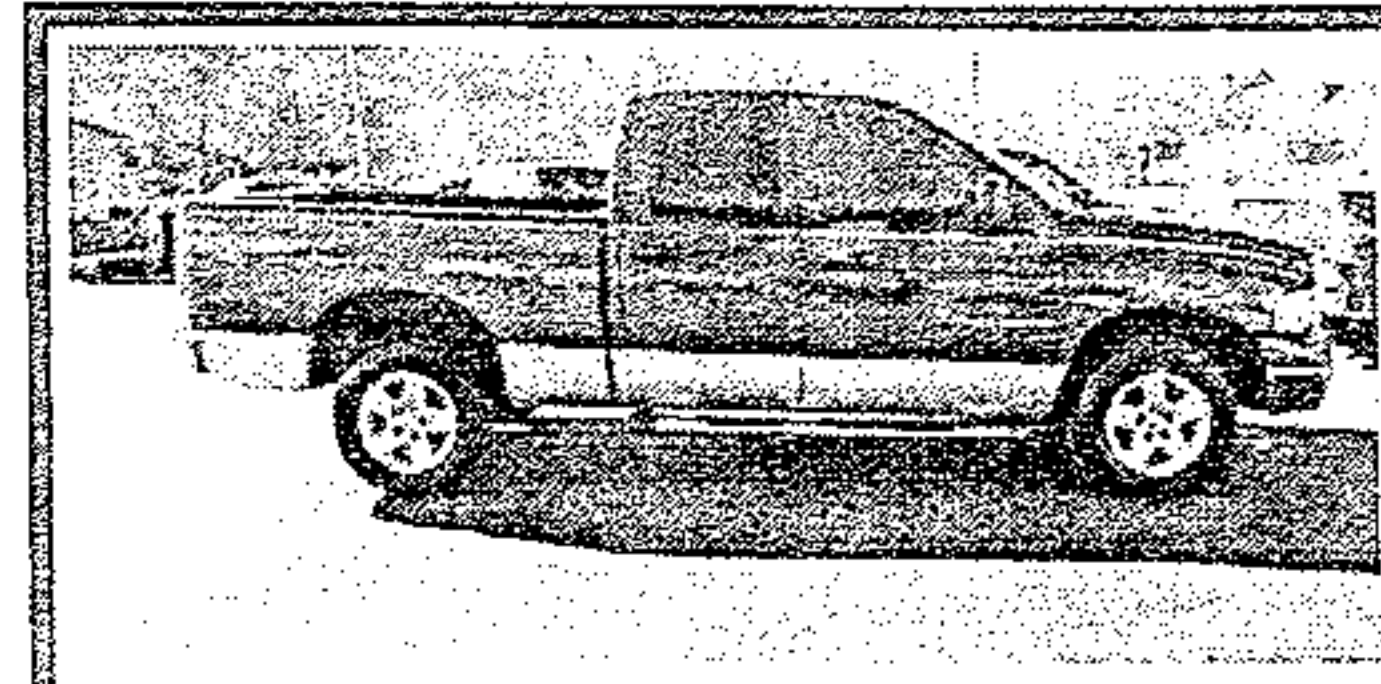

2004 Dodge Ram 1500, 4dr,  
4x4, Nice Truck!!!

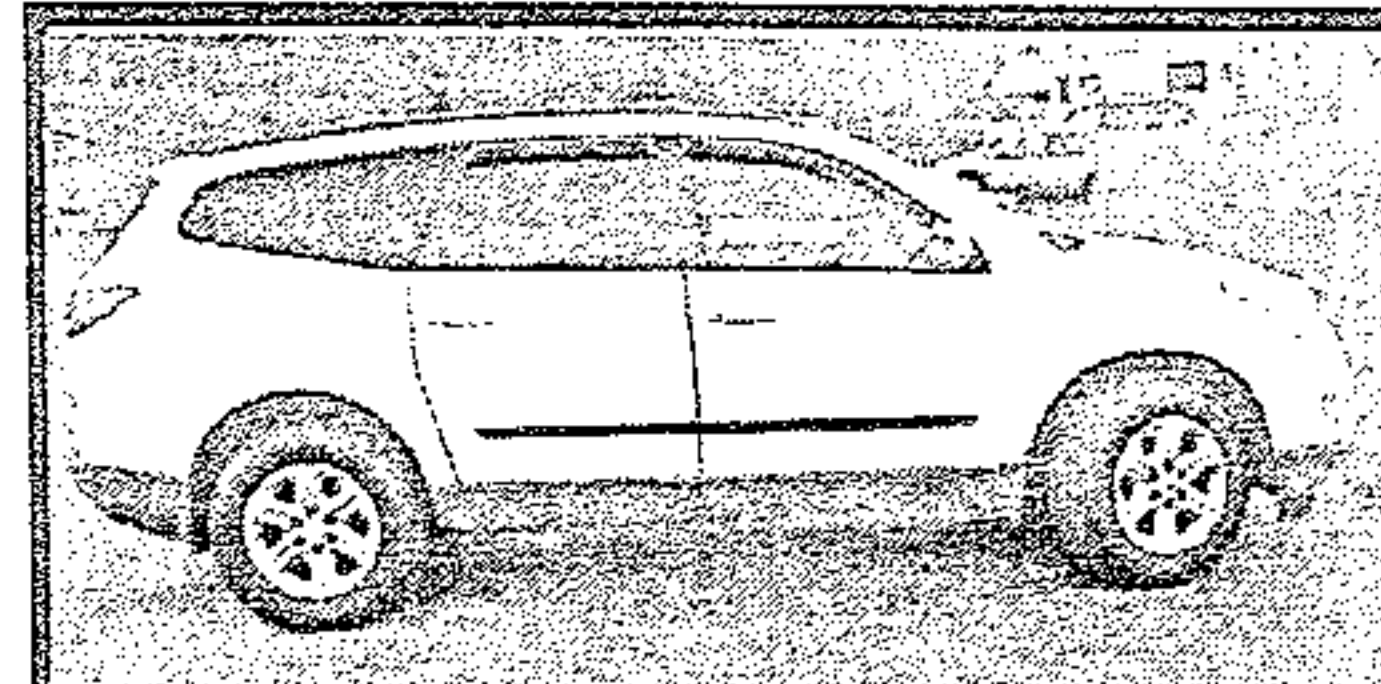

2010 Chevy Traverse, 3rd row  
seat, Loaded, Clean

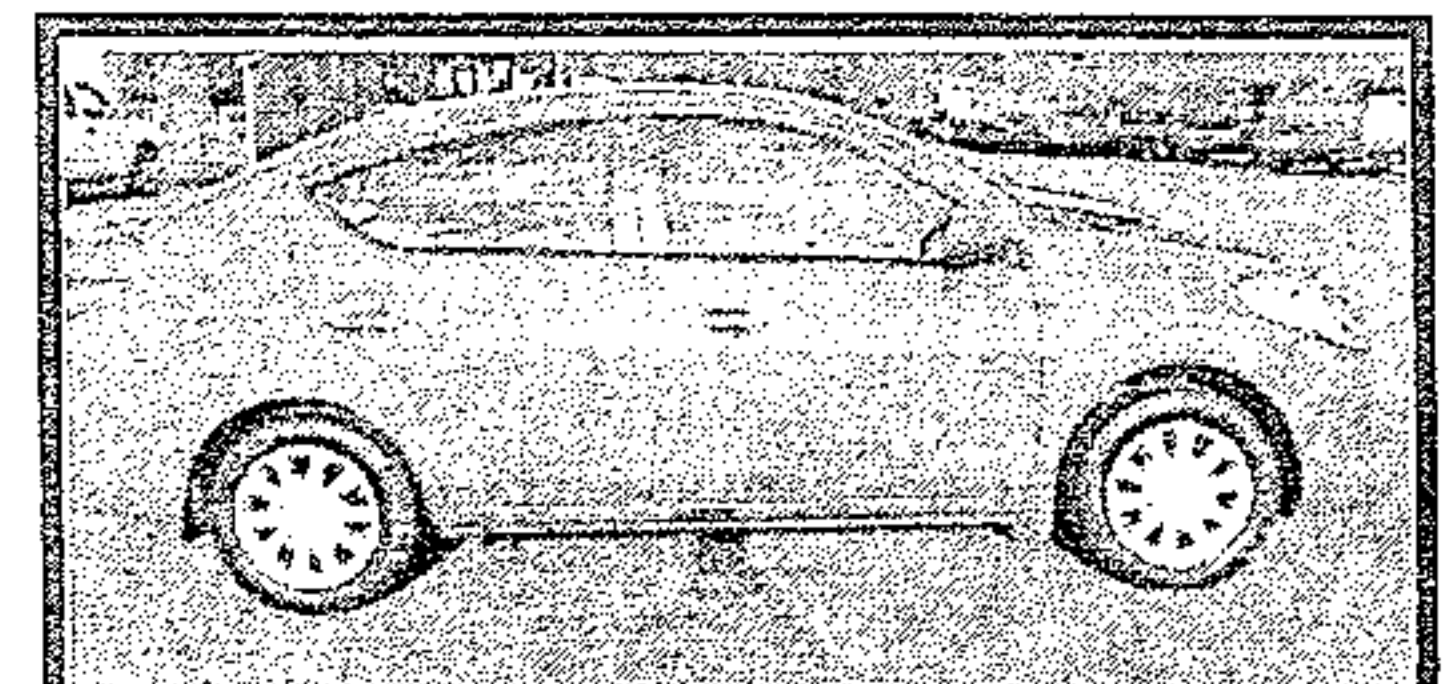

2013 Nissan Versa, Like New!  
LOADED!!!

# WALT WILLIAMS, INC.

\*with approved credit

3003 Highway 11

Lenoir City, TN

**865-986-1111**