

The Daily Edition

50¢

Serving Loudon, Monroe and Surrounding Counties

Monday, January 11, 2016

Lenoir City man charged with rape of a child x3 by LCSO

A Hines Valley Road, Lenoir City man has been charged with three counts of rape of a child. The charges follow a DCS referral and subsequent LCSO investigation. Following the investigation Investigator Jeff Russell placed charges against Terry Shelton.

(see rape pg. 7)

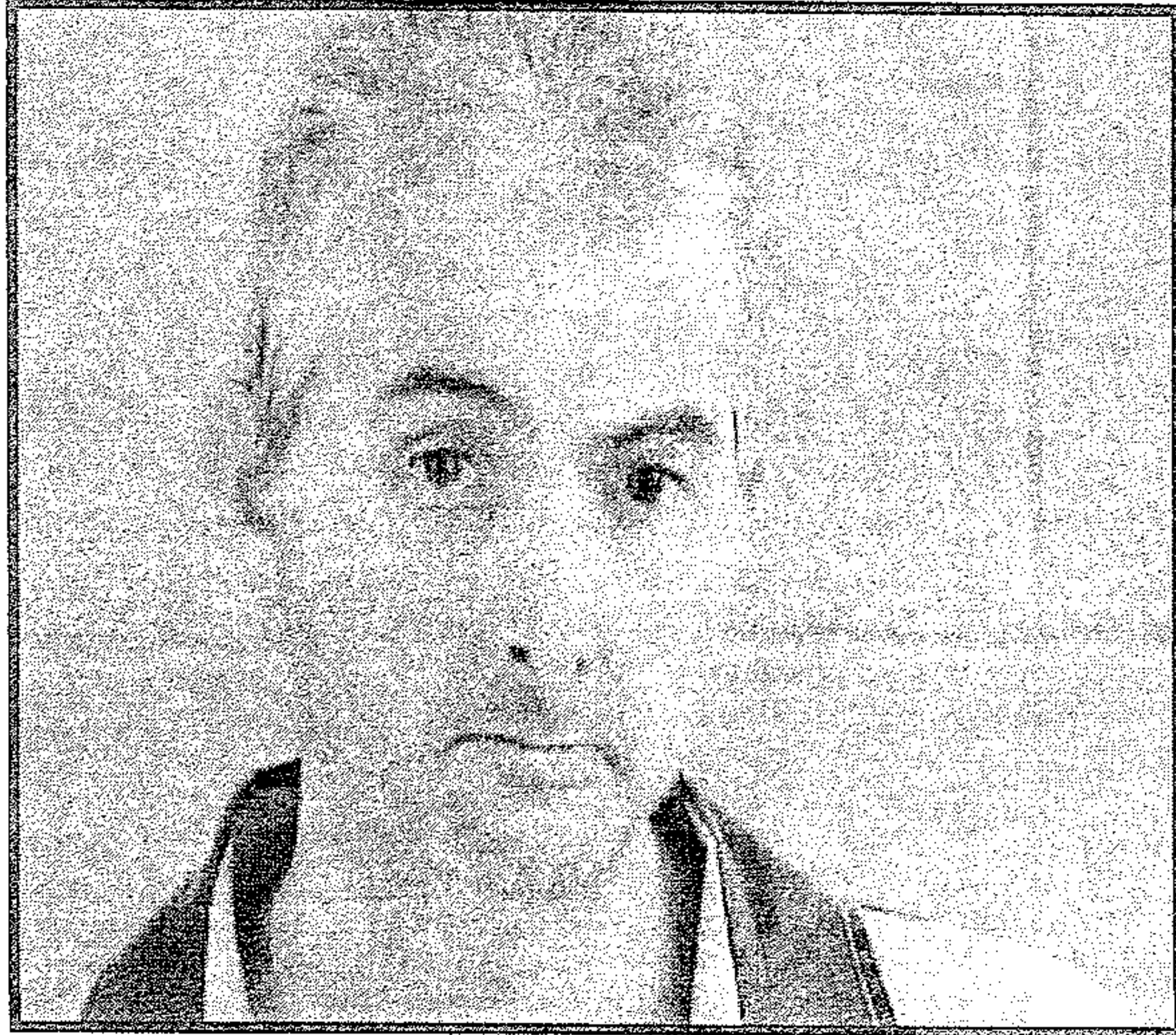

Terry Shelton

Teen charged with theft over \$1000 following LCSO investigation



Joseph Carl King
(see theft pg. 3)

Mikel Knight CD and tour promotion passes through



from left Skippy and Baby Giraffe are holding the new CDs from Mikel Knight

(see Knight pg. 2)

Drug exchange charge in high crime area; TA Truck Stop



Casey Foster



Kimberly Davis

(see exchange pg. 5)

Haslam Appoints Roger Amos Page to Tennessee Supreme Court

Appointed to replace Justice Gary R. Wade, subject to confirmation by the General Assembly

Tennessee Gov. Bill Haslam today appointed Roger Amos Page of Madison County to the Tennessee Supreme Court, replacing Justice Gary R. Wade, who retired in September.

(see TN pg. 4)



Roger Amos Page

Verse of the Day

Since the day we heard about you, we have not stopped praying for you and asking God to fill you with the knowledge of his will through all spiritual wisdom and understanding. — Colossians 1:9

Obituaries

see inside
Wazzup
Thanks for all your help and expert wisdom Dr. Marty! Thanks for saving me so much money too!

Weather

Today: A mainly sunny sky. High around 40F.
Tonight: Mostly clear. Low 27F.
Tuesday Sunshine and clouds mixed. High 48F.
Tuesday Night Cloudy with rain and snow di-

minishing in the evening
Partial clearing late. Low 21F.
Horoscopes
Capricorn 12/22-1/19
You prefer taking a rational approach to complicated situations, especial-

(Continued on page 6)

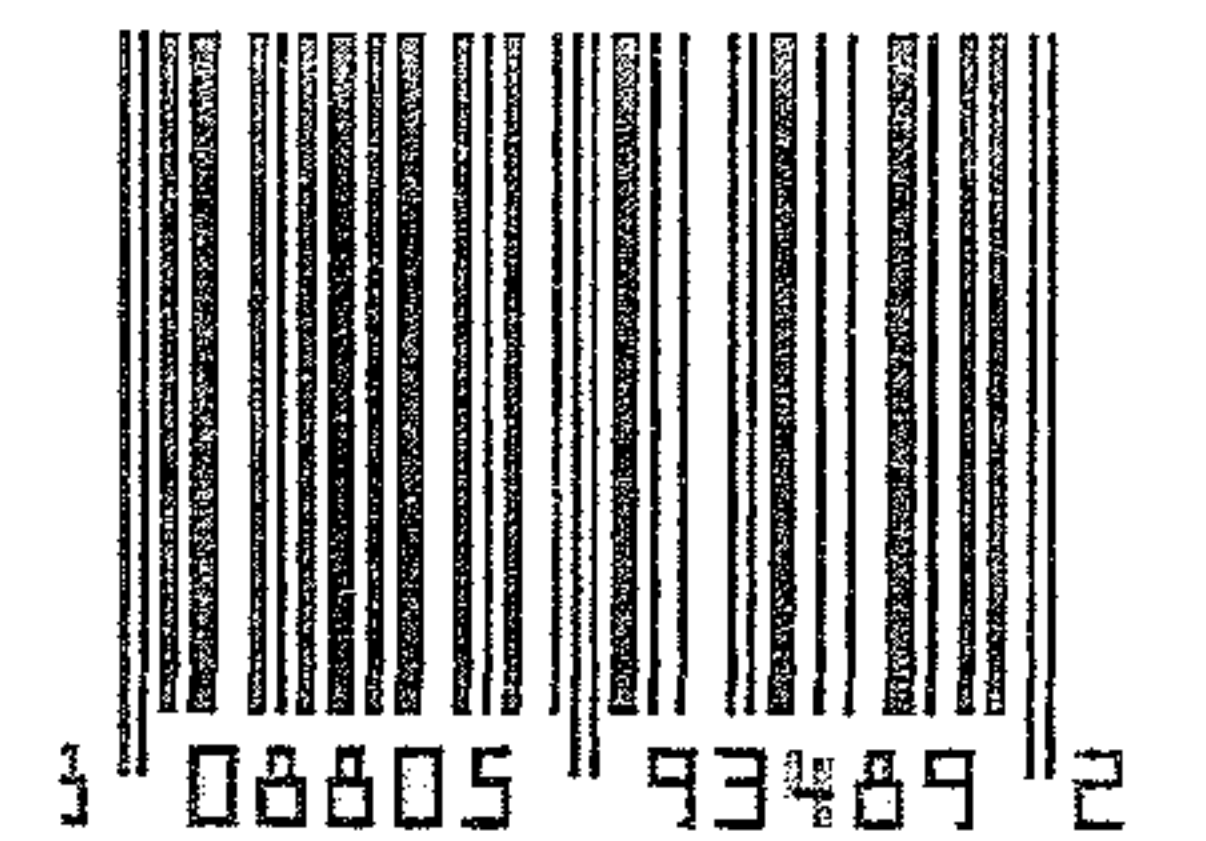

Knight

The "County Rap King" Mikel Knight's entourage recently passed through Loudon County and are promoting Knight's CD's and upcoming tour. One of approximately 80 vans and 5 tour buses stopped at the Aztex in Loudon for a quick visit.

You can check out the website at mikelknight.com

for more information and to get onboard as well with the traveling tour.

To Get a Burning Permit:

Loudon (865) 986-8395

Monroe (423) 442-7401

Roane (865) 354-1054

Knox (865) 215-5900

Get Paid To Wave! Now Hiring Wavers at Liberty Tax

Apply in person at Liberty Tax, East Broadway Lenoir City or Hwy 321 Lenoir City. Must be dependable, and ready to work.

Notice

Reward offered for the return of a handmade black walnut baby cradle and 700 strands of African trade beads stolen from our home. If you have any information please call 865-250-9280.

Notice: The Daily Edition does not knowingly accept fraudulent or misleading materials. The Daily Edition cannot guarantee the validity of offerings or statements contained herein. All liability for the contents of all advertising, and for any claims that may arise therefrom, is the responsibility of the advertiser or its agency. The Daily Edition reserves the right to reject, edit, or abbreviate any advertisement submitted. Advertising is accepted with the understanding that all liability for all copyright violations is the sole responsibility of the advertiser.

Photographs, artwork and other copy submitted for publication is considered the sole property of the advertiser. The Daily Edition will make every effort but will not be liable for failure to publish and ad or for typographical and layout errors. All statements and information about highlights featured items, letters to the editor, herein are those solely given to the interviewer or writer and the Daily Edition assumes no responsibility of the accuracy or validity thereof. The Daily Edition will gladly reprint at no charge that part of an advertisement in which an error occurs provided a claim is made within 3 days of the first publication of the ad. Information contained in the Wazzup is received anonymously and the Daily Edition assumes no responsibility for information and reserves the right to edit or reject any and/or all submissions. The Daily Edition is a daily newspaper of general circulation in Loudon County defined under TCA 2-1-104(a)(13).

The Daily Edition also serves Monroe, Knox, Anderson, Roane and Blount counties and serves 30,000 readers weekly. Send mail to PO Box 1240, Lenoir City TN 37771. 865-771-2249. email: dan1204us@yahoo.com

The Daily Edition is Loudon County's premier public interest and paid advertising paper. The Daily Edition is produced and published daily Monday through Friday and is circulated throughout Loudon County and parts of Monroe and Knox Counties. Display advertising rates \$5.00 per column inch and quantity discounts available. Call for information on upcoming promotions and events.

HACIENDA Ayala's

Mexican Restaurant

Market Dr. * Lenoir City (In Front of Food City)

Real Authentic Mexican Food at Affordable Prices

BEST

MARGARITA

You've Tried The Rest Now Come Have The Best!!!

We Accept ALL Competitors Coupons Outside of Mexico City!

986-3553

Good Credit OK • Bad Credit OK • Bankruptcies OK • Repo OK



2010 Kia Soul Sporty, 4 cyl, Auto, PW, PL, A/C, Great On Gas, Like New



2010 Ford Escape Limited Leather, Alloy Wheels, Heat, A/C, Luggage Rack, 79K,



2007 Dodge Ram 1500 Quad Cab, Thunder Road PKG, 20 in. Wheels, Low Miles, Hemi



2008 Ford Explorer 84k, 3rd Row Seating, Luggage Rack, Tow Pkg, PW, PL



2011 Ford Ranger Low Miles, Tow Pkg, New Tires, A/C, Heat, Bed Liner.



2011 Dodge Grand Caravan DVD, Stow & Go, Loaded, Remote Doors, Rear A/C

DEPENDABLE MOTORS 986-9343

803 E. Broadway • Lenoir City

Serving Loudon County for 20 Years

* WAC. See Dealer for details

Visit our website at: www.dependablemotorslc.com

theft

Joseph King, 19, Coy-eteer Circle Lenoir City, was charged with Theft of Property. Victim reported to the LCSO that someone had stolen several items from his

residence. Items consist of a Guitar worth 2500, several power tools and gold rings, necklace, and a Wii play station. Victim gave a suspect name. After an investigation was complete, Joseph King was charged. Investigator Jeff Russell LCSO, made the arrest.

Judge

Page, 60, has been a judge on the Tennessee Court of Criminal Appeals since his appointment by Haslam in December 2011, writing more than 330 appellate opinions. He previously served as a circuit court judge for the 26th Judicial District, which includes Chester, Henderson and Madison counties. In that position, he presided over more than 300 civil and

criminal jury trials.

"We are fortunate to have someone with such a depth of experience for this important position," Haslam said. "Judge Page has a distinguished career both as a judge and an attorney, and Tennesseans will benefit from having him on the Supreme Court."

Page's appointment is subject to confirmation by the Tennessee General Assembly.

"I have been honored to serve the citizens of Tennessee for the past 18 years as a member of the judiciary, and I am humbled by the governor's confidence in selecting me for the Tennessee Supreme Court," Page said.

Prior to his experience on the bench, Page was assistant attorney general for the state in Jackson from 1991-

(see judge ctd. pg. 5)

For Sale: oak Wood Mulch

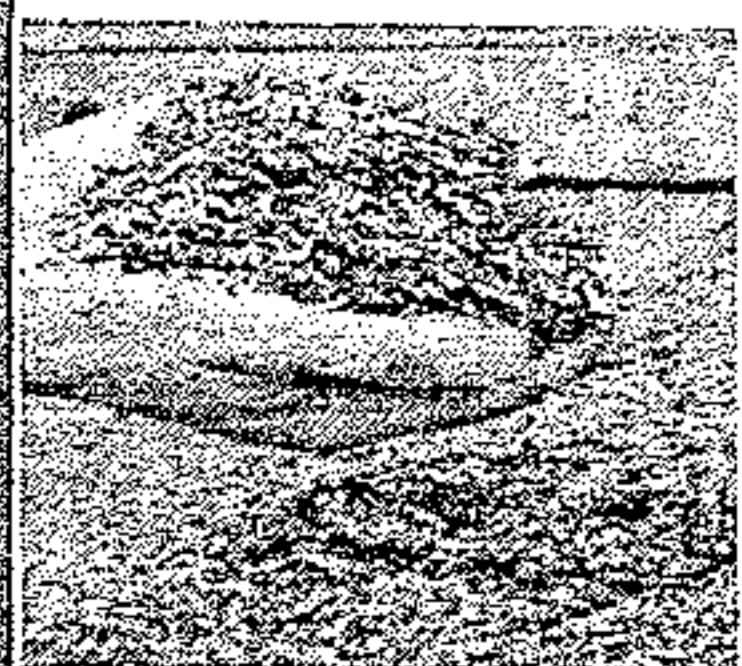

Mushroom Compost Topsoil.

Firewood



Call Steve Spoon 986-4282

STAINED INC

TATTOO & PIERCING

LENOIR CITY 865 816-6440

NEW OWNER • NEW ARTIST • SINCE 2011

521 Hwy 321 next to Vape & Stuff & Inn Of Lenoir!

Clean-Affordable-Quality-Custom

Tattoo's You've Always Wanted!

BRING IN THIS AD FOR **\$25 OFF!**
NEW INK FOR NEW CUSTOMERS ONLY!

Check us out on FB.com/
Stained.Inc.Tattoo/
www.STAINEDINC.com



BIMBO'S

Deli Open 24 Hours

865-986-9643 Call Ins Welcome

Specials

Lg. Cold Sub, bag of chips and 16 oz. fountain drink only \$6.29

Footlong Corn Dog \$2.59

West End Storage & Warehouses
502 Ward Avenue • Loudon
Call 865-458-4774 or 865-679-5555



C&J Towing and Recovery

LOWEST TOWING RATES AROUND!!!

Have you been overcharged for any type of towing service in the Lenoir City area? If you have a breakdown or accident please OWNER REQUEST C&J Towing with the officer. Also please call your Sheriff and ask him to place C&J Towing on the "Rotation List*" and help other motorists save as much as you did! We at C&J are locally owned and operated, State approved, licensed, bonded and insured. Call and let us know if your denied service or how we can be of assistance.

*note: the "Rotation List" is a list of wrecker services that provide service for wrecks, DUI's, breakdowns, etc. and are on an on-call basis for service. This list is approved by the Sheriff.

Cliff Teeters • Owner
865-809-1661

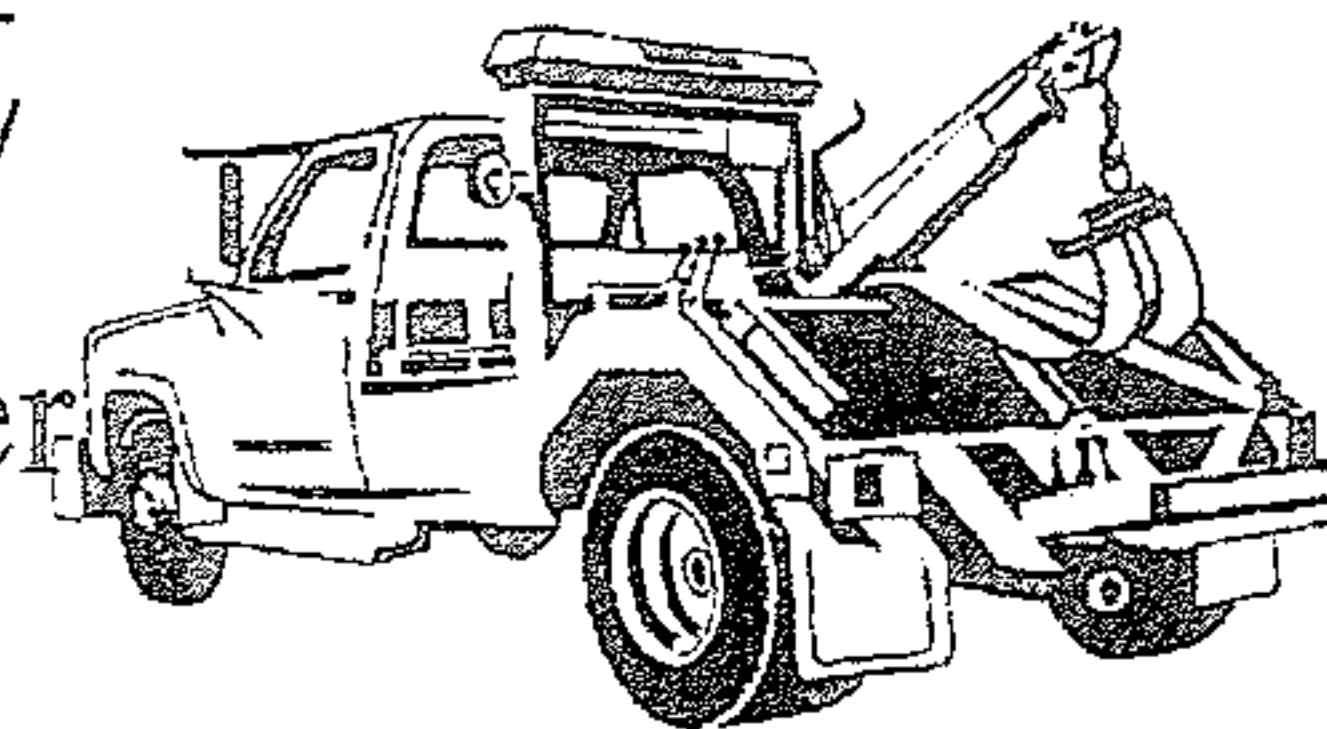

Haslam Makes Appointments to State Boards and Commissions

Governor appoints 102 Tennesseans to 64 boards and commissions

Tennessee Gov. Bill Haslam today announced the appointments of 102 Tennesseans to 64 boards and commissions.

"I am grateful to these men and women for their willingness to serve and for their commitment to our state," Haslam said.

The governor continues to evaluate the state's complete range of boards and commissions to ensure Tennesseans have a government that is responsive, effective and efficient.

Appointment terms are varied due to differing statutory requirements or term limits determined by specific qualifications. The appointments are:

Advisory Committee on Credit Life Insurance Rates
Dakasha Winton, Antioch
Advisory Council for Alternative Education

Kay Davenport, Smyrna
Jack Elder, Thompson's Station

Chris Liner, Athens
Jay Stezel, Lebanon
Air Pollution Control Board

Shawn Lindsey, Athens
Architects and Engineers Board of Examiners

Susan Hadley Maynor, Memphis

Board for Licensing Contractors

Jerry Hayes, Paris
Board for Licensing Health Care Facilities

Paul Boyd, Memphis
Thomas Gee, Paris

Board for Professional Counselors, Marital and Family Therapists, and Clinical Pastoral Therapists
Jennifer Little, Bean Station

Board of Appeals
Aaron Conklin, Murfreesboro

Jonathan Steen, Jackson
Board of Chiropractic Examiners

Nancy Strawn, Dyersburg
Board of Dietitian and Nutritionist Examiners

Jackie Daughtry, Millington

Samuel Sisley, Johnson City

Board of Dispensing Opticians

Les Freeman, Arlington
Board of Examiners for Nursing Home Administrators

Buffy Key, Baxter
Cindy Wheeler, Hixson

Board of Examiners in Psychology
Hugh Moore, Memphis

Jennifer Winfree, Gordonsville
Board of Ground Water Management

James Watson, Lascasas
Board of Nursing

Lee Mills, Arlington
Board of Occupational Therapy

Drew Daniel, Memphis
Board of Optometry

Torrey Carlson, Jonesborough
Brad Lindsey, Morristown

Jennifer Uhl, Gallatin
Board of Osteopathic Examination

Penny Grace Judd, Goodlettsville
Board of Parole

Zane Duncan, Knoxville

(see Haslam etd. pg. 7)

How ABOUT \$50 YOU DIDN'T HAVE BEFORE?

Just come to Liberty Tax, let us do your taxes and we'll hand you \$50 cash on the spot.

119 E. Broadway Street
Downtown Hwy 11
820 Hwy 321 N
Across from Burger King



LIBERTY TAX SERVICE
Lenoir City, TN 37771
865-986-8335

with paid tax preparation. Valid at participating locations. Cannot be combined with other offers or used toward past services.
One coupon per return. Expires 2-15-15

APPLY FOR AN EASY ADVANCE AND GET MONEY FAST!

\$750 Easy Advance at Liberty Tax at No Additional Cost!



820 Hwy 321 N 119 E. Broadway Street
Across from Burger King Downtown Hwy 11

Lenoir City, TN 37771
865-986-8335

An Easy Advance (EA) is a \$750 loan secured by your tax refund and is offered by Republic Bank & Trust Company, member FDIC, to qualifying applicants. There are no fees or interest associated with the EA. Subject to approval. Visit your Liberty office to learn more. Offer Expires 2-28-15.

BUDGET
Transmissions

Why Buy From Budget?

Free Towing From Lenoir City or Loudon County

20 Years of BBB Zero Customer Complaints Award Member

A+ Plus Rated

Huge Transmission Inventory

Best Technicians Period!!!

Call (865) 584-4391 Today!

302 S. Northshore Drive Knoxville

(865) 584-4391





State-of-the-Art Diagnostics



We have the experience, knowledge & latest tools to get you back on the road.

budget-transmissions.com

exchange

Kimberly Davis, 28, Angewood Drive Crossville, was charged with Man/Sell/Del/Resale SCH. VI.

Casey Foster, 20, Riverwalk Drive Sevierville, was charged with Man/Sell/Del/Resale of SCH. VI.

Deputy Bobby Hamilton LCSO, was at the TA Truck Stop when

he observed a Truck pull in the parking lot at a fast speed. The truck pulled up beside a small white vehicle the male driver of the truck exited the vehicle and exchanged something with the female in the small car. The male got back in the truck and the female was looking down at what she received from the male. Due to the truck stop

being a high crime area Deputy approach the vehicle and identified the driver of the truck as Casey Foster, and the female driver and Kimberly Davis. Both parties told Deputy they were meeting because they were friends. After asking question both parties could not tell Deputy each other names. Deputy could smell the odor of marijuana coming from

the vehicles. Deputy called Investigator Shane Ezell LCSO, in to investigate. After an investigation both parties were placed under arrest. Inv. Shane Ezell LCSO, made the arrest.

Judge ctd. from pg. 3

1998. He practiced at Holmes, Rich, Sigler & Page, P.C. in Jackson from 1987-1991. He was an associate at

Peterson, Young, Self & Asselin in Atlanta from 1985-1987 and a law clerk for then-U.S. District Court Judge Julia Smith Gibbons from 1984-1985.

Page received his law degree with honors in 1984 from the University of Memphis, where he ranked 4th in his class.

Before his legal career, Page was chief pharmacist and assistant store manager for Walgreens in Memphis, where he worked from 1977-1984. He received a bachelor's degree in pharmacy in 1978 from the University of Tennessee College of Pharmacy in Memphis. He attended the University of Tennessee at Martin from 1973-1975 after graduating from Chester County High School in Henderson.

Page has been active in his community. He is a member and past president of the board of directors of the Jackson Lions Club. He coached Dixie Youth Baseball for 12 years and is a member of First Baptist Church in Jackson.

Page, a Henderson native, is married to Davidson County Chancellor Carol McCoy. He has two children and three grandchildren.

- See more at: <https://www.tn.gov/news/23005#sthash.AlkhJvHr.dpuf>

Place Your Ad In The Daily Edition. Call 865-771-2249

PURDY'S AUTO PARTS AND SALVAGE

WE BUY SCRAP IRON • COPPER • BRASS • ALUMINUM

\$ **Paying Top \$\$\$**
Call For Latest Prices

You Name It, We Buy It!

Radiators, Wheels, Batteries, Appliances, Farm Equipment

Copper
Paying Top \$\$\$
Call For Latest Prices

Complete Cars
per 100 lbs.

Scrap Metal
Paying Top \$\$\$
Call For Latest Prices
per 100 lb

We Buy Batteries

Aluminum Cans
Paying Top \$\$\$
Call For Latest Prices

You Call We Haul!
423-519-5402

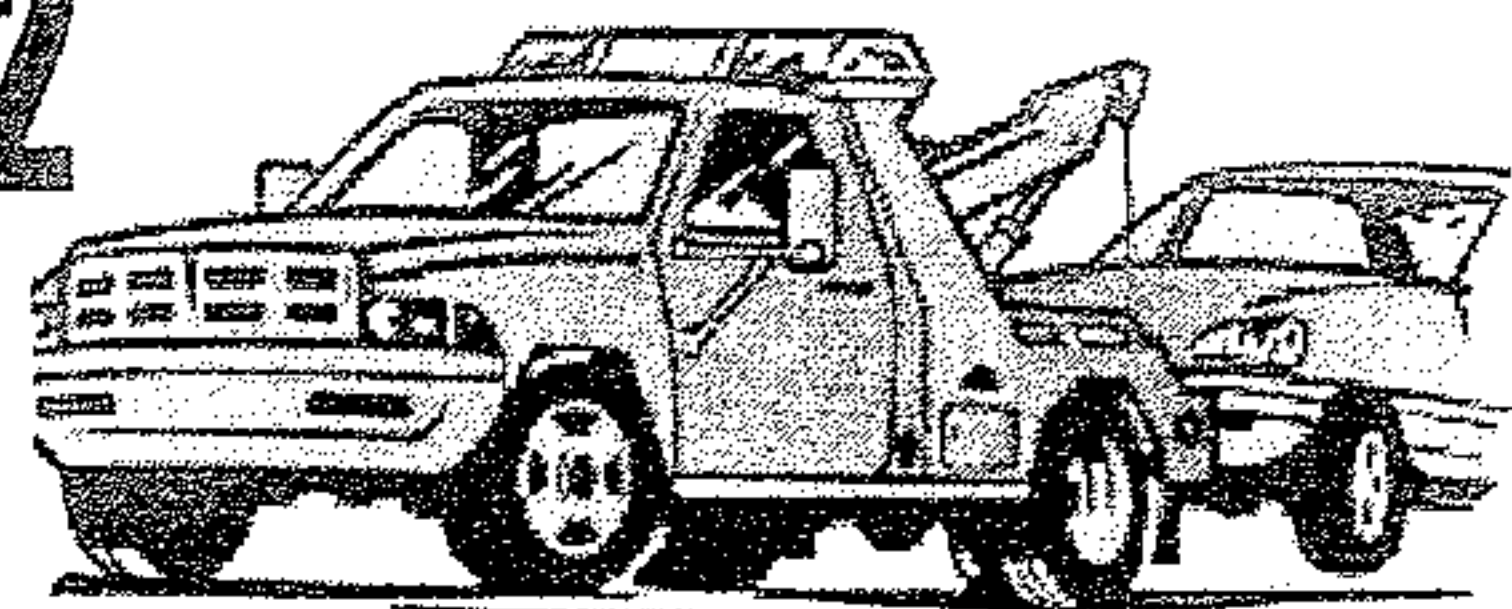

Prices subject to change with the market.

423 337-3977
149 County Road 323 Sweetwater

Now Selling Aftermarket Body Parts at Discount Prices

Prices subject to change with the market.

rape

Terry Shelton, 36, Hines Valley Road Lenoir City, was charged with Rape of a Child x3.

Investigator Jeff Russell LCSO, received a DCS referral on Monday January 4th that victim disclosed to DCS

that he had been sexual touched and a forensic interview was set up on January 5th. Investigator Jeff Russell LCSO, attended the interview where victim disclosed that Terry Shelton had touched him and made him do sexual things to Terry on more than one occasion.

After investigation was complete Terry was charged and placed under arrest. Investigator Jeff Russell LCSO, made the arrest.

Haslam ctd. from pg. 4

- Timothy Gobble, Cleveland
- Roberta Kustoff, Memphis Board of Physical Therapy
- Beth Buttrey, Memphis
- LeAnn Childress, Dyersburg Board of Regents
- MaryLou Apple, Tullahoma Board of Respiratory Care
- Anna Ambrose, Springfield Board of Social Worker Licensure
- Elizabeth Randall, Johnson City Committee on Physician Assistants
- Benjamin Hux, Sevierville
- David Crockett Commission
- Bill Jenkins, Rogersville
- Anne Locke, Nashville Education Commission of

- the States
- Tammy Grissom, Hendersonville Governor's Council for Armed Forces, Veterans, and their Families
- Christina Mick, Cookeville Interagency Coordinating Council
- Katari Coleman, Nashville
- Gary Smith, Nashville Pest Control Board
- Robert Frost, Nashville
- Don Holt, White Pine Polysomnography Professional Standards Committee
- Daniel Brown, Dandridge
- Theresa Hill, Memphis
- Roxanne Valentino, Hendersonville Prevailing Wage Commission
- Rab Summers, Jonesborough
- Stephen Wright, Charleston
- Sam Davis Memorial Association Board of Trustees
- Carol Davis, Smyrna
- Ginny Williams, Smyrna
- Mike Bradley, Smyrna State Board of Accountancy

- Judy Wetherbee, Nashville State Board of Pharmacy
- Rissa Pryse, LaFollette State Capitol Commission
- King Rogers, Memphis
- Tammy White, Knoxville State Rehabilitation Council
- Norm Nelson, Powell Statewide Independent Living Council
- Ann Eubank, Cane Ridge Statewide Planning and Policy Council for the Department of Intellectual and Developmental Disabilities
- Jennifer Enderson, Knoxville
- Phil Garner, Waynesboro Tennessee Athletic Commission
- Donald Wynn, Nashville Tennessee Board of Court Reporting
- John Rambo, Jonesborough Tennessee Career and Technical Education Council
- Charles Rains, Dunlap Tennessee Collection Services Board
- Angela Hoover, Franklin Tennessee Commission on Children and Youth
- Lisa Hill, Bartlett

- Petrina Jones-Jesz, Cane Ridge Tennessee Community Services Agency Statewide Board of Directors
- Shauna Bryant, Columbia
- Gerry Campbell, Jackson Tennessee Corrections Institute Board of Control
- Elizabeth Lewis, Harriman Tennessee Council for the Deaf, Deaf-Blind and Hard of Hearing
- Louvisia Conley, Memphis Tennessee Duck River Development Agency
- Hershel Mayberry, Centerville Tennessee Historical Commission
- Ernie Bacon, Franklin
- Lucy Lee, Lebanon Tennessee Housing Development Agency
- Kim Grant Brown, Memphis
- Jim Sattler, Chattanooga Tennessee Medical Laboratory Board
- Gaye Jolly, Knoxville Tennessee Motor Vehicle Commission
- Victor Evans, Nashville

see obits conc. pg. 8

LOOK!
\$75 Weekly Payments
LOOK!

MARTY'S AUTO SALES • 986-2222
MARTY'S AUTO SALES • 986-2222
MARTY'S AUTO SALES • 986-2222
MARTY'S AUTO SALES • 986-2222
MARTY'S AUTO SALES • 986-2222

Bad Credit

Divorce

Fixed Income

Repos

Bankruptcy

No Credit

APPROVED!

Visit Us On The Web At:

martysautosales.net

NO

CREDIT

CHECKS

\$499 down*

07 Cobalt, 5spd, gas saver, runs great Only \$499 down*

\$499 down*

96 Chevy 1500, Low Miles, auto, Only \$499 down*

\$299 down*

95 Camry, auto, Gas Saver, Only \$299 down*

\$499 down*

01 Sebring 2dr. sporty, Only \$499 down*

\$299 down*

00 Civic, auto, Gas Saver, Only \$299 down*

\$399 down*

93 Ford F150, 4x4, auto Only \$399 down*

\$399 down*

03 Hyundai Elantra, Gas Saver, Only \$399 down*

\$99 down*

98 Bonneville, 6 cyl, Auto, low payments only \$99 down*

NO Credit Checks

Marty's Auto Sales

986-2222

Se Habla Espanol

100% Approval*

*See Dealer for details. All down payments plus tax, tag, title and fees.

MARTY'S AUTO SALES • 986-2222
MARTY'S AUTO SALES • 986-2222
MARTY'S AUTO SALES • 986-2222
MARTY'S AUTO SALES • 986-2222
MARTY'S AUTO SALES • 986-2222

Haslam conc. from pg. 7
 Nathaniel Jackson, Memphis
 Don Parr, Pulaski
 Kahren White, Maryville
 Tennessee Real Estate Commission
 Johnny Horne, Chattanooga
 Tennessee Residence Commission
 Jane Martin, Nashville
 Thomas Smith, Nashville
 Tennessee State Veterans'

Homes Board
 Miles Burdine, Kingsport
 Tennessee Suicide Prevention Advisory Council
 Adam Graham, Nashville
 Sandra Perley, Columbia
 Ellen Stowers, Tullahoma
 Tennessee Tombigbee Waterways Development Authority
 John Bennett, Chattanooga
 Cathy Campbell Holland, Nashville
 Marty Marbry, Memphis

A Name You Already Know And Trust Just Got Even More Dependable
DEPENDABLE AUTO SERVICE, LUBE AND TIRES
 is Now Offering
Expert, Affordable Transmission Service
 All ASE Certified Technicians

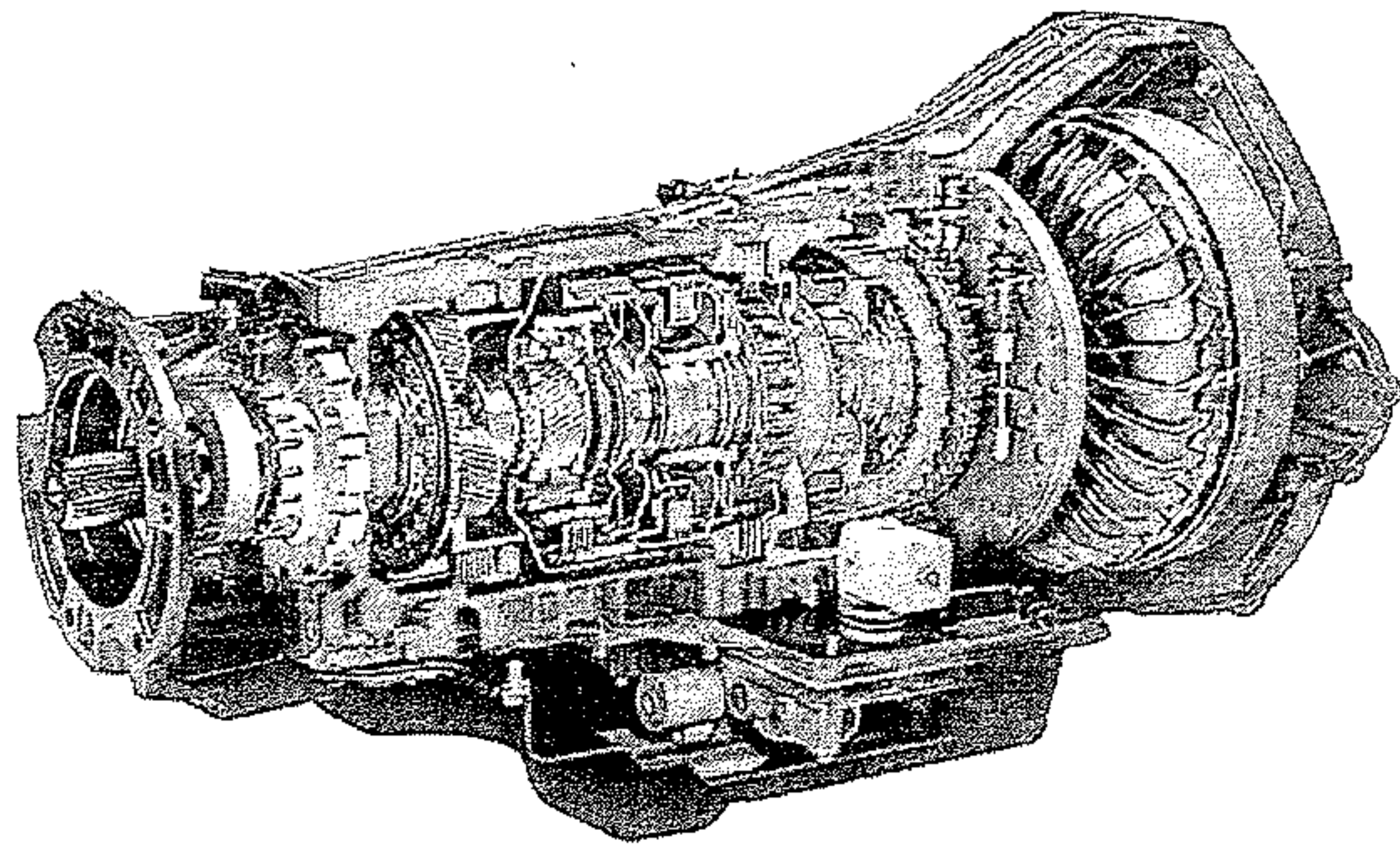

We proudly welcome all New Customers and Former Advanced Transmission Customers with a 10% Discount and Any Transmission Service or Repair*

865-986-9359

865-986-5050

THE RELIC SHOP

521 Hwy 321 Lenoir City Suite 3
 next to Stained Inc and the Inn of Lenoir

NOW OPEN
865-250-9280

WHERE A PERSON CAN BUY A PIECE OF HISTORY
 INDIAN ARTIFACTS, CIVIL WAR RELICS, FOSSILS
 ANTIQUE GUNS, ANTIQUE POCKETWATCHES,
 OLD COINS AND WHOLE LOT MORE!!!

Is Your Washer Broken?

Call Me
 I Only Charge \$100 Period!!!
 Call Allen
 865-617-7113

Bad Credit, No Credit OK!!! We Finance Everybody!!!

Taxes Done Here!!! Bring your last pay stub or W2 and DRIVE TODAY!!!

Over 100 Cars, Trucks & Vans in Stock - Warranties On ALL Vehicles Sold!!!



2005 Ford Ranger, Super Nice Truck, Very Low Miles

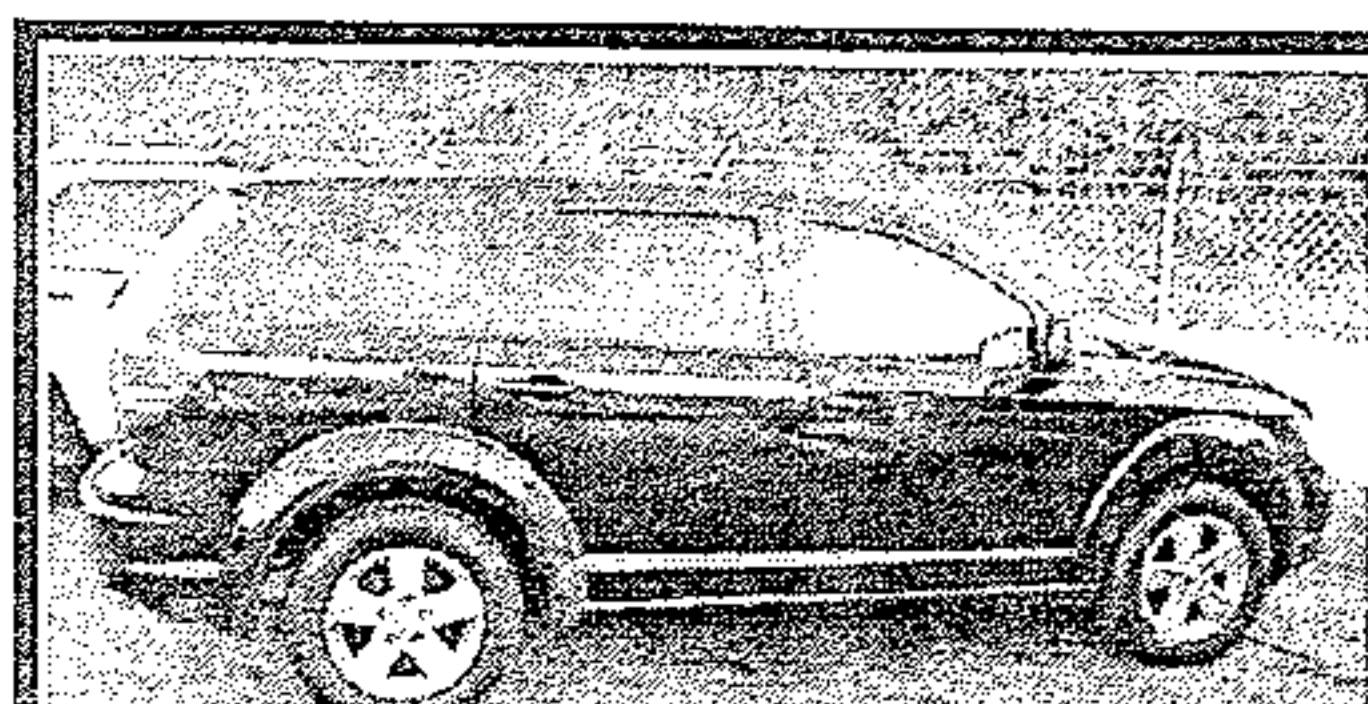

2009 Dodge Journey, 4dr, Loaded, Nice Ride



2011 Kia Soul, 5 speed, 4 dr, Gas Saver, Nice & Clean



2007 Chevy Equinox, 4dr, Extra Clean, lots of room

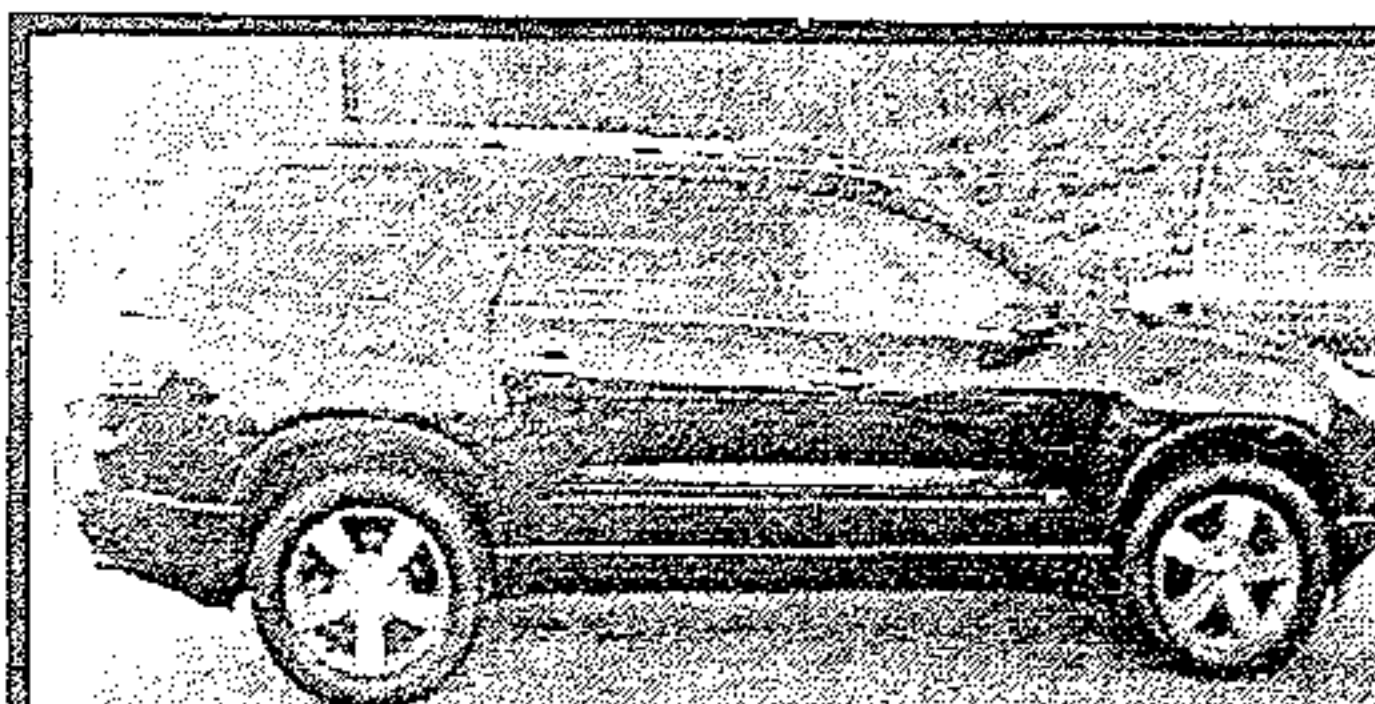

2010 GMC Acadia, Leather, 3rd row, sunroof, Loaded

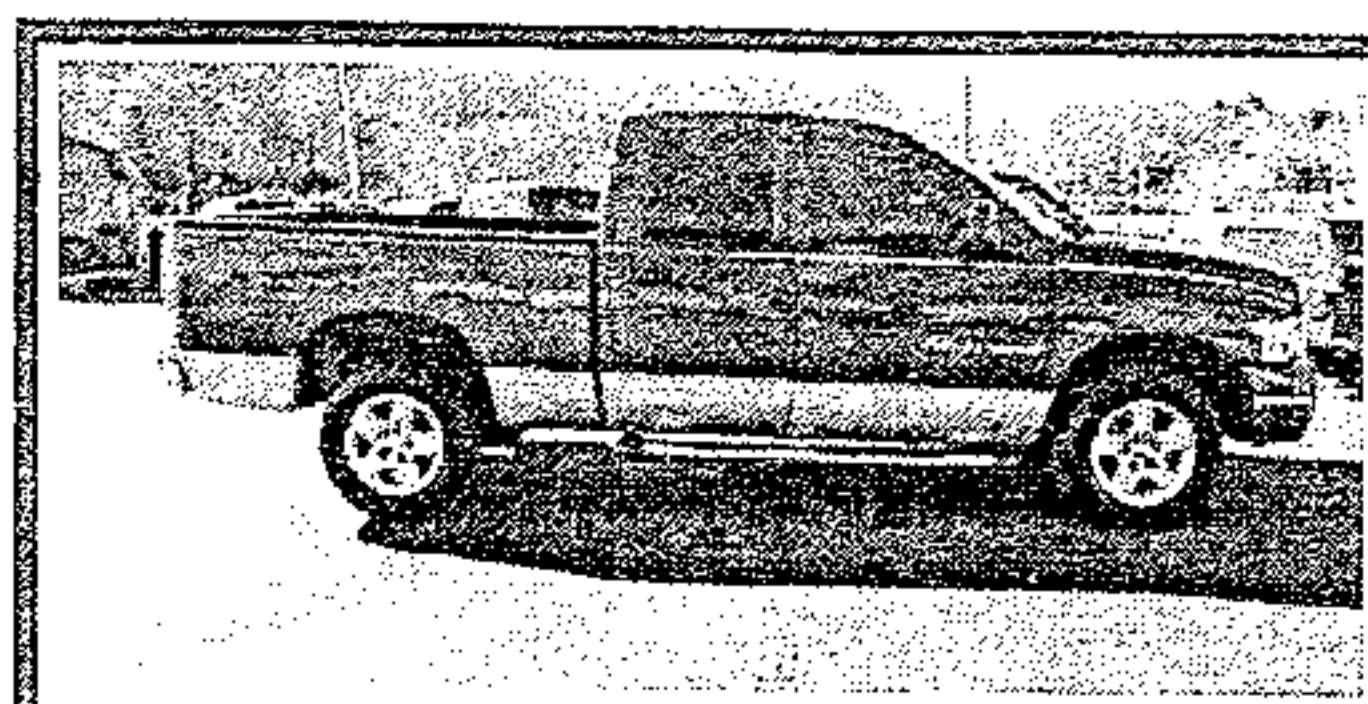

2004 Dodge Ram 1500, 4dr, 4x4, Nice Truck!!!

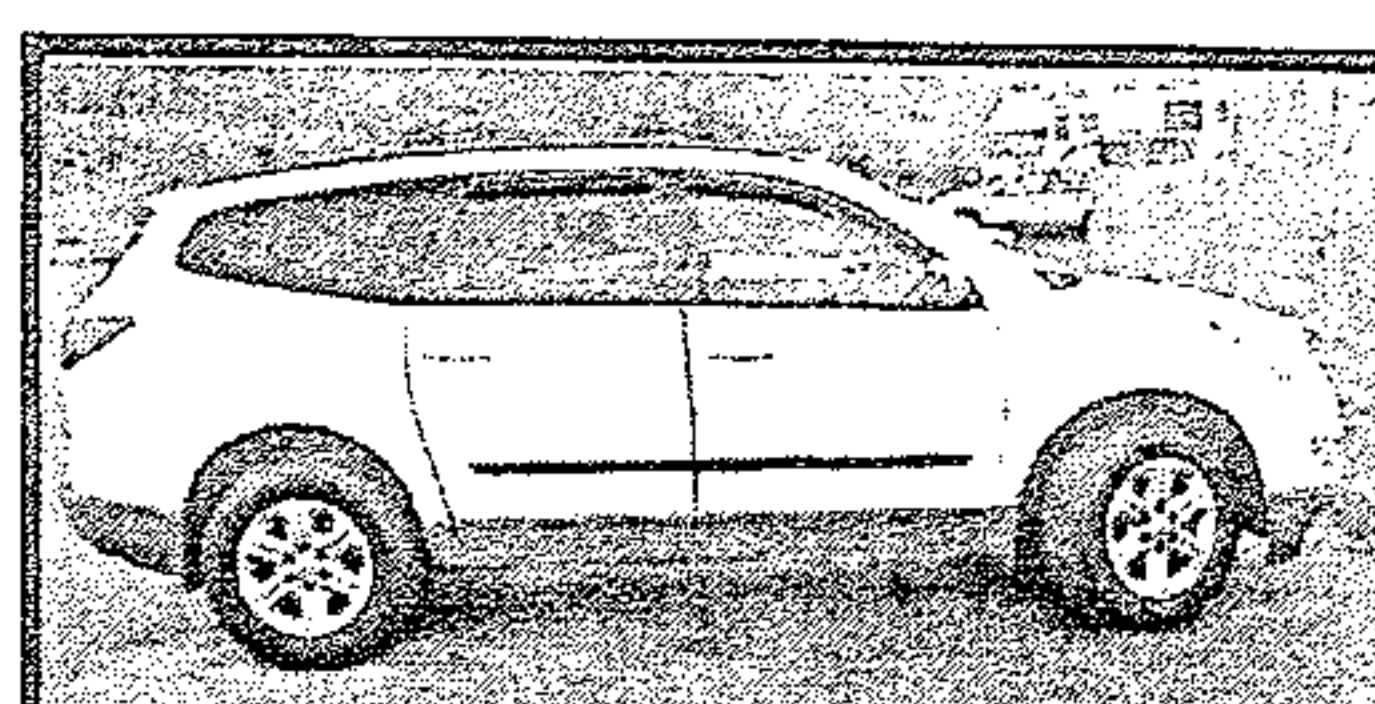

2010 Chevy Traverse, 3rd row seat, Loaded, Clean



2013 Nissan Versa, Like New! LOADED!!!

WALT WILLIAMS, INC.

*with approved credit

3003 Highway 11 Lenoir City, TN 865-986-1111